

Copyright © 2001, by the author(s).
All rights reserved.

Permission to make digital or hard copies of all or part of this work for personal or classroom use is granted without fee provided that copies are not made or distributed for profit or commercial advantage and that copies bear this notice and the full citation on the first page. To copy otherwise, to republish, to post on servers or to redistribute to lists, requires prior specific permission.

**-PTOLEMY II-
HETEROGENEOUS CONCURRENT
MODELING AND DESIGN IN JAVA**

by

John Davis, II, Christopher Hylands, Bart Kienhuis,
Edward A. Lee, Jie Liu, Xiaojun Liu, Lukito Muliadi,
Steve Neuendorffer, Jeff Tsay, Brian Vogel,
Yuhong Xiong.

Previous Authors:

Mudit Goel, Lukito Muliadi, John Reekie, Neil Smyth

Memorandum No. UCB/ERL M01/12

11 March 2001

**-PTOLEMY II-
HETEROGENEOUS CONCURRENT
MODELING AND DESIGN IN JAVA**

by

John Davis, II, Christopher Hylands, Bart Kienhuis, Edward A. Lee, Jie Liu, Xiaojun Liu,
Lukito Muliadi, Steve Neuendorffer, Jeff Tsay, Brian Vogel, Yuhong Xiong

Previous Authors:

Mudit Goel, Lukito Muliadi, John Reekie, Neil Smyth

Memorandum No. UCB/ERL M01/12

11 March 2001

ELECTRONICS RESEARCH LABORATORY

College of Engineering
University of California, Berkeley
94720

-PTOLEMY II -

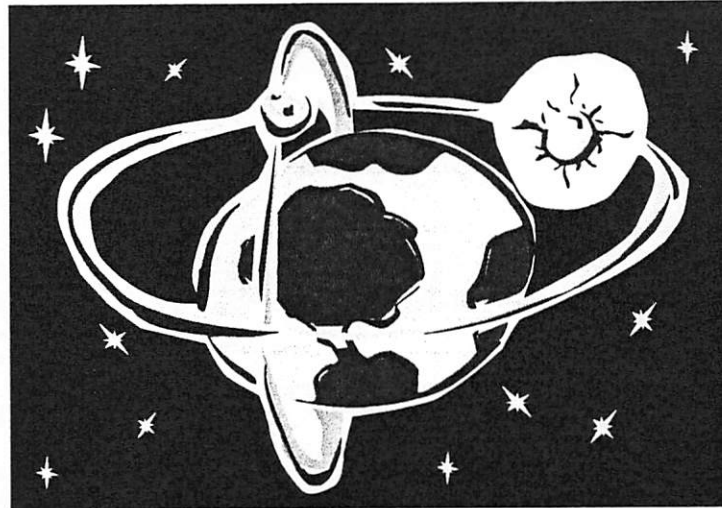

HETEROGENEOUS CONCURRENT MODELING AND DESIGN IN JAVA

*John Davis, II
Christopher Hylands
Bart Kienhuis
Edward A. Lee
Jie Liu
Xiaojun Liu
Lukito Muliadi
Steve Neuendorffer
Jeff Tsay
Brian Vogel
Yuhong Xiong*

*Previous Authors:
Mudit Goel
Lukito Muliadi
John Reekie
Neil Smyth*

*Department of Electrical Engineering and Computer Sciences
University of California at Berkeley
<http://ptolemy.eecs.berkeley.edu>*

*Originally published as Memorandum UCB/ERL M99/40
Document Version 1.0
for use with Ptolemy II 1.0
March 11, 2001*



This project is supported by the Defense Advanced Research Projects Agency (DARPA), the Microelectronics Advanced Research Corporation (MARCO), the State of California MICRO program, and the following companies: Cadence Design Systems, Hewlett Packard, Hitachi, Hughes Space and Communications, Motorola, NEC, and Philips.

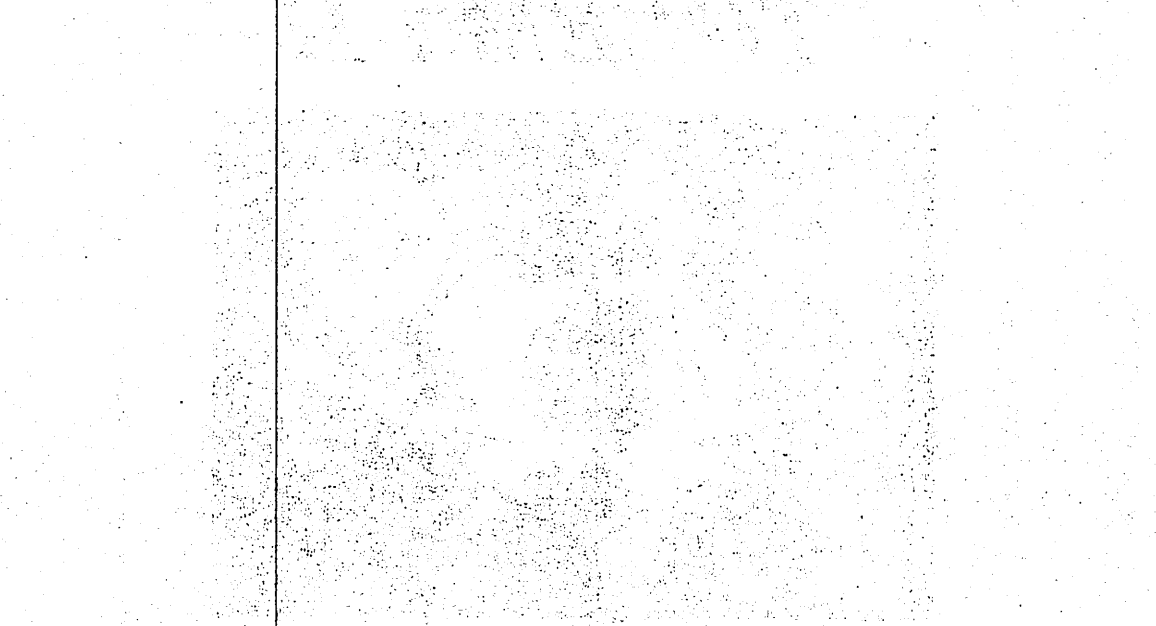

*Copyright © 1998-2001 The Regents of the University of California.
All rights reserved.*

“Java” is a registered trademark of Sun Microsystems.

Contents

Part 1: Using Ptolemy II

1. Introduction 1-1

- 1.1. Modeling and Design 1-1
- 1.2. Architecture Design 1-3
- 1.3. Models of Computation 1-4
 - 1.3.1. *Communicating Sequential Processes - CSP 1-4*
 - 1.3.2. *Continuous Time - CT 1-4*
 - 1.3.3. *Discrete-Events - DE 1-5*
 - 1.3.4. *Distributed Discrete Events - DDE 1-6*
 - 1.3.5. *Discrete Time - DT 1-6*
 - 1.3.6. *Finite-State Machines - FSM 1-6*
 - 1.3.7. *Process Networks - PN 1-7*
 - 1.3.8. *Synchronous Dataflow - SDF 1-7*
 - 1.3.9. *Giotto 1-7*
 - 1.3.10. *Synchronous/Reactive - SR 1-8*
- 1.4. Choosing Models of Computation 1-8
- 1.5. Visual Syntaxes 1-9
- 1.6. Ptolemy II Architecture 1-11
 - 1.6.1. *Core Packages 1-11*
 - 1.6.2. *Overview of Key Classes 1-13*
 - 1.6.3. *Domains 1-14*
 - 1.6.4. *Library Packages 1-16*
 - 1.6.5. *User Interface Packages 1-17*
 - 1.6.6. *Capabilities 1-17*
 - 1.6.7. *Future Capabilities 1-20*
- Appendix: UML — Unified Modeling Language 1-21
 - Package Diagrams 1-21*
 - Static Structure Diagrams 1-21*
- Appendix: Ptolemy II Naming Conventions 1-25
 - Classes 1-25*
 - Members 1-25*
 - Methods 1-25*

2. Using Vergil 2-1

- 2.1. Introduction 2-1
- 2.2. Quick Start 2-2
- 2.3. Data Types and the Type System 2-3
- 2.4. Hierarchy 2-5
- 2.5. Broadcast Relations 2-6
- 2.6. SDF and Multirate Systems 2-7

-
- 2.7. Using the Plotter 2-8
 - 3. Actor Libraries 3-1**
 - 3.1. Overview 3-1
 - 3.2. Actor Classes 3-2
 - 3.3. Actor Summaries 3-4
 - 3.3.1. *Sources* 3-5
 - 3.3.2. *Sinks* 3-7
 - 3.3.3. *Math* 3-10
 - 3.3.4. *Flow Control* 3-12
 - 3.3.5. *Logic* 3-14
 - 3.3.6. *Conversions* 3-14
 - 3.3.7. *Array* 3-16
 - 3.3.8. *Signal Processing* 3-16
 - 3.3.9. *Continuous Time* 3-21
 - 3.3.10. *Discrete Event* 3-22
 - 3.4. Data Polymorphism 3-23
 - 3.5. Domain Polymorphism 3-24
 - 4. Designing Actors 4-1**
 - 4.1. Overview 4-1
 - 4.2. Anatomy of an Actor 4-2
 - 4.2.1. *Ports* 4-2
 - 4.2.2. *Parameters* 4-6
 - 4.2.3. *Constructors* 4-8
 - 4.2.4. *Cloning* 4-9
 - 4.3. Action Methods 4-10
 - 4.3.1. *Initialization* 4-10
 - 4.3.2. *Prefire* 4-11
 - 4.3.3. *Fire* 4-13
 - 4.3.4. *Postfire* 4-13
 - 4.3.5. *Wrapup* 4-15
 - 4.4. Time 4-16
 - 4.5. Code Format 4-16
 - 4.5.1. *Indentation* 4-16
 - 4.5.2. *Spaces* 4-17
 - 4.5.3. *Comments* 4-17
 - 4.5.4. *Names* 4-17
 - 4.5.5. *Exceptions* 4-18
 - 4.5.6. *Javadoc* 4-18
 - 4.5.7. *Code Organization* 4-20
 - 5. MoML 5-1**
 - 5.1. Introduction 5-1
 - 5.2. MoML Principles 5-3
 - 5.2.1. *Clustered Graphs* 5-4
 - 5.2.2. *Abstraction* 5-5
 - 5.3. Specification of a Model 5-5
 - 5.3.1. *Data Organization* 5-6
 - 5.3.2. *Overview of XML* 5-8
-

5.3.3.	<i>Names and Classes</i>	5-8
5.3.4.	<i>Model Element</i>	5-9
5.3.5.	<i>Entity Element</i>	5-9
5.3.6.	<i>Properties</i>	5-11
5.3.7.	<i>Doc Element</i>	5-12
5.3.8.	<i>Ports</i>	5-14
5.3.9.	<i>Relations and Links</i>	5-15
5.3.10.	<i>Classes</i>	5-17
5.3.11.	<i>Inheritance</i>	5-19
5.3.12.	<i>Directors</i>	5-20
5.3.13.	<i>Input Element</i>	5-20
5.3.14.	<i>Annotations for Visual Rendering</i>	5-20
5.4.	Incremental Parsing	5-22
5.4.1.	<i>Adding Entities</i>	5-22
5.4.2.	<i>Using Absolute Names</i>	5-23
5.4.3.	<i>Adding Ports, Relations, and Links</i>	5-23
5.4.4.	<i>Changing Port Configurations</i>	5-24
5.4.5.	<i>Deleting Entities, Relations, and Ports</i>	5-24
5.4.6.	<i>Renaming Objects</i>	5-24
5.4.7.	<i>Changing Documentation, Properties, and Directors</i>	5-24
5.4.8.	<i>Removing Links</i>	5-25
5.4.9.	<i>Grouping Elements</i>	5-26
5.5.	Parsing MoML	5-26
5.6.	Exporting MoML	5-28
5.7.	Special Attributes	5-29
5.8.	Acknowledgements	5-29
Appendix:	Example	5-30
	<i>Sinewave Generator</i>	5-30
	<i>Modulation</i>	5-33
6.	Custom Applets	6-1
6.1.	Introduction	6-1
6.2.	HTML Files Containing Applets	6-2
6.3.	Defining a Model in a Java File	6-3
6.3.1.	<i>A Model Class as a Composite Actor</i>	6-3
6.3.2.	<i>Compiling</i>	6-5
6.3.3.	<i>Executing the Model in an Application</i>	6-7
6.3.4.	<i>Extending PtolemyApplet</i>	6-8
6.3.5.	<i>Using Model Parameters</i>	6-8
6.3.6.	<i>Adding Custom Actors</i>	6-9
6.3.7.	<i>Using Jar Files</i>	6-10
6.3.8.	<i>Hints for Developing Applets</i>	6-13
Part 2: Software Architecture		
7.	The Kernel	7-1
7.1.	Abstract Syntax	7-1
7.2.	Non-Hierarchical Topologies	7-2
7.2.1.	<i>Links</i>	7-2

-
- 7.2.2. *Consistency* 7-3
 - 7.3. Support Classes 7-5
 - 7.3.1. *Containers* 7-5
 - 7.3.2. *Name and Full Name* 7-5
 - 7.3.3. *Workspace* 7-6
 - 7.3.4. *Attributes* 7-6
 - 7.3.5. *List Classes* 7-7
 - 7.4. Clustered Graphs 7-7
 - 7.4.1. *Abstraction* 7-7
 - 7.4.2. *Level-Crossing Connections* 7-10
 - 7.4.3. *Tunneling Entities* 7-11
 - 7.4.4. *Cloning* 7-11
 - 7.4.5. *An Elaborate Example* 7-12
 - 7.5. Opaque Composite Entities 7-14
 - 7.6. Concurrency 7-15
 - 7.6.1. *Limitations of Monitors* 7-16
 - 7.6.2. *Read and Write Access Permissions for Workspace* 7-17
 - 7.6.3. *Making a Workspace Read Only* 7-18
 - 7.7. Mutations 7-18
 - 7.7.1. *Change Requests* 7-20
 - 7.7.2. *NamedObj and Listeners* 7-20
 - 7.8. Exceptions 7-21
 - 7.8.1. *Base Class* 7-21
 - 7.8.2. *Less Severe Exceptions* 7-21
 - 7.8.3. *More Severe Exceptions* 7-22
 - 8. Actor Package 8-1**
 - 8.1. Concurrent Computation 8-1
 - 8.2. Message Passing 8-2
 - 8.2.1. *Data Transport* 8-2
 - 8.2.2. *Example* 8-5
 - 8.2.3. *Transparent Ports* 8-6
 - 8.2.4. *Data Transfer in Various Models of Computation* 8-8
 - 8.2.5. *Discussion of the Data Transfer Mechanism* 8-11
 - 8.3. Execution 8-11
 - 8.3.1. *Director* 8-14
 - 8.3.2. *Manager* 8-15
 - 8.3.3. *ExecutionListener* 8-18
 - 8.3.4. *Opaque Composite Actors* 8-18
 - 8.4. Scheduler and Process Support 8-20
 - 8.4.1. *Statically Scheduled Domains* 8-20
 - 8.4.2. *Process Domains* 8-22
 - 9. Data Package 9-1**
 - 9.1. Introduction 9-1
 - 9.2. Data Encapsulation 9-1
 - 9.3. Polymorphism 9-3
 - 9.3.1. *Polymorphic Arithmetic Operators* 9-3
 - 9.3.2. *Lossless Type Conversion* 9-5
-

9.3.3.	<i>Limitations</i>	9-6
9.4.	Variables and Parameters	9-6
9.4.1.	<i>Values</i>	9-8
9.4.2.	<i>Types</i>	9-8
9.4.3.	<i>Dependencies</i>	9-10
9.5.	Expressions	9-10
9.5.1.	<i>The Ptolemy II Expression Language</i>	9-10
9.5.2.	<i>Limitations</i>	9-15
9.6.	Fixed Point Data Type	9-15
9.6.1.	<i>FixPoint Implementation</i>	9-16
9.6.2.	<i>FixPoint</i>	9-16
9.6.3.	<i>FixToken</i>	9-16
9.6.4.	<i>Expression Language</i>	9-18
Appendix:	Expression Evaluation	9-19
	<i>Generating the parse tree</i>	9-19
	<i>Evaluating the parse tree</i>	9-20
10.	Graph Package	10-1
10.1.	Introduction	10-1
10.2.	Classes and Interfaces in the Graph Package	10-2
10.2.1.	<i>Graph</i>	10-3
10.2.2.	<i>Directed Graphs</i>	10-3
10.2.3.	<i>Directed Acyclic Graphs and CPO</i>	10-4
10.2.4.	<i>Inequality Terms, Inequalities, and the Inequality Solver</i>	10-4
10.3.	Example Use	10-5
10.3.1.	<i>Generating A Schedule for A Composite Actor</i>	10-5
10.3.2.	<i>Forming and Solving Constraints over a CPO</i>	10-6
11.	Type System	11-1
11.1.	Introduction	11-1
11.2.	Formulation	11-3
11.2.1.	<i>Type Constraints</i>	11-3
11.2.2.	<i>Run-time Type Checking and Lossless Type Conversion</i>	11-6
11.3.	Structured Types	11-6
11.4.	Implementation	11-7
11.4.1.	<i>Implementation Classes</i>	11-7
11.4.2.	<i>Type Checking and Type Resolution</i>	11-8
11.4.3.	<i>Setting Up Type Constraints</i>	11-10
11.4.4.	<i>Some Implementation Details</i>	11-11
11.5.	Examples	11-12
11.5.1.	<i>Polymorphic DownSample</i>	11-12
11.5.2.	<i>Fork Connection</i>	11-13
11.6.	Actors Constructing Tokens with Structured Types	11-13
Appendix:	The Type Resolution Algorithm	11-15
12.	Plot Package	12-1
12.1.	Overview	12-1
12.2.	Using Plots	12-2
12.2.1.	<i>Zooming and filling</i>	12-3
12.2.2.	<i>Printing and exporting</i>	12-3

-
- 12.2.3. *Editing the data* 12-4
 - 12.2.4. *Modifying the format* 12-5
 - 12.3. **Class Structure** 12-7
 - 12.3.1. *Toolkit classes* 12-7
 - 12.3.2. *Applets and applications* 12-7
 - 12.3.3. *Writing applets* 12-12
 - 12.4. **PlotML File Format** 12-12
 - 12.4.1. *Data organization* 12-13
 - 12.4.2. *Configuring the axes* 12-14
 - 12.4.3. *Configuring data* 12-17
 - 12.4.4. *Specifying data* 12-18
 - 12.4.5. *Bar graphs* 12-19
 - 12.4.6. *Histograms* 12-19
 - 12.5. **Old Textual File Format** 12-20
 - 12.5.1. *Commands Configuring the Axes* 12-20
 - 12.5.2. *Commands for Plotting Data* 12-21
 - 12.6. **Compatibility** 12-23
 - 12.7. **Limitations** 12-23
 - 13. Vergil** 13-1
 - 13.1. **Introduction** 13-1
 - 13.2. **Infrastructure** 13-2
 - 13.2.1. *Design Artifacts* 13-2
 - 13.2.2. *Storage policies* 13-2
 - 13.2.3. *Views* 13-3
 - 13.3. **Architecture** 13-3
 - 13.3.1. *Effigies and Tableaux* 13-3
 - 13.3.2. *Effigy Factories* 13-3
 - 13.3.3. *Tableau Factories* 13-5
 - 13.3.4. *Model Directory* 13-5
 - 13.3.5. *Configurations* 13-5
 - 13.3.6. *TableauFrame* 13-6
 - 13.4. **Common operations** 13-7
 - 13.4.1. *Opening an Existing Design Artifact* 13-7
 - 13.4.2. *Creating a New Design Artifact* 13-8
 - 13.4.3. *Saving Changes to a Design Artifact* 13-9
 - 13.4.4. *Closing designs and Exiting the Application* 13-9
 - 13.5. **Ptolemy Model Visualization** 13-10
 - 13.5.1. *Graph Tableau* 13-10
 - 13.5.2. *FSM Tableau* 13-12
 - 13.5.3. *Tree Tableau* 13-14

Part 3: Domains

14. CT Domain 14-1

- 14.1. **Introduction** 14-1
 - 14.1.1. *System Specification* 14-3
 - 14.1.2. *Time* 14-5
- 14.2. **Solving ODEs numerically** 14-5

14.2.1.	<i>Basic Notations</i>	14-5
14.2.2.	<i>Fixed-Point Behavior</i>	14-6
14.2.3.	<i>ODE Solvers Implemented</i>	14-7
14.2.4.	<i>Discontinuity</i>	14-8
14.2.5.	<i>Breakpoint ODE Solvers</i>	14-8
14.3.	CT Actors	14-9
14.3.1.	<i>CT Actor Interfaces</i>	14-9
14.3.2.	<i>Actor Library</i>	14-9
14.3.3.	<i>Domain Polymorphic Actors</i>	14-11
14.4.	CT Directors	14-12
14.4.1.	<i>ODE Solvers</i>	14-12
14.4.2.	<i>CT Director Parameters</i>	14-12
14.4.3.	<i>CTMultiSolverDirector</i>	14-13
14.4.4.	<i>CTMixedSignalDirector</i>	14-13
14.4.5.	<i>CTEmbeddedDirector</i>	14-14
14.5.	Interacting with Other Domains	14-14
14.6.	CT Domain Demos	14-15
14.6.1.	<i>Lorenz System</i>	14-15
14.6.2.	<i>Microaccelerometer with Digital Feedback.</i>	14-17
14.6.3.	<i>Sticky Point Masses System</i>	14-18
14.7.	Implementation	14-20
14.7.1.	<i>ct.kernel.util package</i>	14-20
14.7.2.	<i>ct.kernel package</i>	14-20
14.7.3.	<i>Scheduling</i>	14-21
14.7.4.	<i>Controlling Step Sizes</i>	14-25
14.7.5.	<i>Mixed-Signal Execution</i>	14-26
14.7.6.	<i>Hybrid System Execution</i>	14-26
Appendix: Brief Mathematical Background		14-27
15.	DE Domain	15-1
15.1.	Introduction	15-1
15.1.1.	<i>Model Time</i>	15-1
15.1.2.	<i>Simultaneous events</i>	15-2
15.1.3.	<i>Iteration</i>	15-3
15.1.4.	<i>Getting a Model Started</i>	15-4
15.1.5.	<i>Pure Events at the Current Time</i>	15-4
15.1.6.	<i>Stopping Execution</i>	15-4
15.2.	Overview of The Software Architecture	15-4
15.3.	The DE Actor Library	15-6
15.4.	Mutations	15-6
15.5.	Writing DE Actors	15-8
15.5.1.	<i>General Guidelines</i>	15-8
15.5.2.	<i>Examples</i>	15-11
15.5.3.	<i>Thread Actors</i>	15-12
15.6.	Composing DE with Other Domains	15-15
15.6.1.	<i>DE inside Another Domain</i>	15-15
15.6.2.	<i>Another Domain inside DE</i>	15-17
16.	SDF Domain	16-1

-
- 16.1.Purpose of the Domain 16-1
 - 16.2.Using SDF 16-1
 - 16.2.1. *Deadlock* 16-1
 - 16.2.2. *Consistency of data rates* 16-3
 - 16.2.3. *How many iterations?* 16-4
 - 16.3.Properties of the SDF domain 16-4
 - 16.3.1. *Scheduling* 16-5
 - 16.3.2. *Hierarchical Scheduling* 16-6
 - 16.4.Software Architecture 16-7
 - 16.4.1. *SDF Director* 16-7
 - 16.4.2. *SDF Scheduler* 16-9
 - 16.4.3. *SDF ports and receivers* 16-10
 - 16.4.4. *ArrayFIFOQueue* 16-11
 - 16.5.Actors 16-11
 - 17. FSM Domain 17-1**
 - 17.1.Introduction 17-1
 - 17.2.Building FSMs in Vergil 17-2
 - 17.2.1. *Alternate Mark Inversion Coder* 17-2
 - 17.3.The Implementation of FSMActor 17-4
 - 17.3.1. *Guard Expressions* 17-4
 - 17.3.2. *Actions* 17-5
 - 17.3.3. *Execution* 17-6
 - 17.4.Modal Models 17-7
 - 17.4.1. *A Schmidt Trigger Example* 17-7
 - 17.4.2. *Implementation* 17-9
 - 17.4.3. *Applications* 17-10
 - 18. CSP Domain 18-1**
 - 18.1.Introduction 18-1
 - 18.2.Using CSP 18-2
 - 18.2.1. *Unconditional vs. Conditional Rendezvous* 18-2
 - 18.2.2. *Time* 18-3
 - 18.3.Properties of the CSP Domain 18-4
 - 18.3.1. *Atomic Communication: Rendezvous* 18-4
 - 18.3.2. *Choice: Nondeterministic Rendezvous* 18-5
 - 18.3.3. *Deadlock* 18-6
 - 18.3.4. *Time* 18-6
 - 18.3.5. *Differences from Original CSP Model as Proposed by Hoare* 18-7
 - 18.4.The CSP Software Architecture 18-7
 - 18.4.1. *Class Structure* 18-7
 - 18.4.2. *Starting the model* 18-8
 - 18.4.3. *Detecting deadlocks:* 18-8
 - 18.4.4. *Terminating the model* 18-11
 - 18.4.5. *Pausing/Resuming the Model* 18-11
 - 18.5.Example CSP Applications 18-11
 - 18.5.1. *Dining Philosophers* 18-12
 - 18.5.2. *Hardware Bus Contention* 18-13
 - 18.6.Technical Details 18-13
-

-
- 18.6.1. *Rendezvous Algorithm* 18-13
 - 18.6.2. *Conditional Communication Algorithm* 18-15
 - 18.6.3. *Modification of Rendezvous Algorithm* 18-17

19. DDE Domain 19-1

- 19.1. Introduction 19-1
- 19.2. Using DDE 19-1
 - 19.2.1. *DDEActor* 19-2
 - 19.2.2. *DDEIOPort* 19-2
 - 19.2.3. *Feedback Topologies* 19-2
- 19.3. Properties of the DDE domain 19-3
 - 19.3.1. *Enabling Communication: Advancing Time* 19-3
 - 19.3.2. *Maintaining Communication: Null Tokens* 19-4
 - 19.3.3. *Alternative Distributed Discrete Event Methods* 19-6
- 19.4. The DDE Software Architecture 19-7
 - 19.4.1. *Local Time Management* 19-7
 - 19.4.2. *Detecting Deadlock* 19-8
 - 19.4.3. *Ending Execution* 19-9
- 19.5. Example DDE Applications 19-10

20. PN Domain 20-1

- 20.1. Introduction 20-1
- 20.2. Using PN 20-2
 - 20.2.1. *Deadlock in Feedback Loops* 20-2
 - 20.2.2. *Designing Actors* 20-2
- 20.3. Properties of the PN domain 20-2
 - 20.3.1. *Asynchronous Communication* 20-2
 - 20.3.2. *Bounded Memory Execution* 20-3
 - 20.3.3. *Time* 20-3
 - 20.3.4. *Mutations* 20-4
- 20.4. The PN Software Architecture 20-4
 - 20.4.1. *BasePNDirector* 20-4
 - 20.4.2. *PNDirector* 20-4
 - 20.4.3. *TimedPNDirector* 20-5
 - 20.4.4. *PNQueueReceiver* 20-5
 - 20.4.5. *Handling Deadlock* 20-6
 - 20.4.6. *Finite Iterations* 20-6

References R-1

Glossary G-1

PART 1:

USING PTOLEMY II

The chapters in this part describe how to construct Ptolemy II models for web-based modeling or building applications. The first chapter includes an overview of Ptolemy II software, and a brief description of each of the models of computation that have been implemented (and some that are just planned). It describes the package structure of the software, and includes as an appendix a brief tutorial on UML notation, which is used throughout this document to explain the structure of the software. The second chapter is a tutorial on building models using Vergil, a graphical user interface where models are built pictorially. The next chapter gives an overview of actor libraries. These two chapters, plus one of the domain chapters, will be sufficient for users to start building interesting models in the selected domain. The fourth chapter gives a tutorial on designing actors in Java. The fifth explains MoML, the XML schema used by Vergil to store models. And the sixth chapter, the final one in this part, explains how to construct custom applets.

1. The first part of the document is a list of names and addresses of the members of the committee. The names are listed in alphabetical order, and the addresses are given in full. The list is as follows:

2. The second part of the document is a report on the work of the committee during the year. It begins with a statement of the committee's purpose and objectives, and then goes on to describe the various activities and projects that were carried out. The report concludes with a summary of the committee's findings and recommendations.

1

Introduction

Author: Edward A. Lee

1.1 Modeling and Design

The Ptolemy project studies heterogeneous modeling, simulation, and design of concurrent systems. The focus is on *embedded systems* [49], particularly those that mix technologies including, for example, analog and digital electronics, hardware and software, and electronics and mechanical devices. The focus is also on systems that are complex in the sense that they mix widely different operations, such as signal processing, feedback control, sequential decision making, and user interfaces.

Modeling is the act of representing a system or subsystem formally. A model might be mathematical, in which case it can be viewed as a set of assertions about properties of the system such as its functionality or physical dimensions. A model can also be constructive, in which case it defines a computational procedure that mimics a set of properties of the system. Constructive models are often used to describe behavior of a system in response to stimulus from outside the system. Constructive models are also called executable models.

Design is the act of defining a system or subsystem. Usually this involves defining one or more models of the system and refining the models until the desired functionality is obtained within a set of constraints.

Design and modeling are obviously closely coupled. In some circumstances, models may be immutable, in the sense that they describe subsystems, constraints, or behaviors that are externally imposed on a design. For instance, they may describe a mechanical system that is not under design, but must be controlled by an electronic system that is under design.

Executable models are sometimes called *simulations*, an appropriate term when the executable model is clearly distinct from the system it models. However, in many electronic systems, a model that starts as a simulation mutates into a software implementation of the system. The distinction between the model and the system itself becomes blurred in this case. This is particularly true for embedded software.

Embedded software is software that resides in devices that are not first-and-foremost computers. It

is pervasive, appearing in automobiles, telephones, pagers, consumer electronics, toys, aircraft, trains, security systems, weapons systems, printers, modems, copiers, thermostats, manufacturing systems, appliances, etc. A technically active person probably interacts regularly with more pieces of embedded software than conventional software. A key feature of embedded software is that it engages the physical world, and hence has temporal constraints that desktop software does not share.

A major emphasis in Ptolemy II is on the methodology for defining and producing embedded software together with the systems within which it is embedded.

Executable models are constructed under a *model of computation*, which is the set of “laws of physics” that govern the interaction of components in the model. If the model is describing a mechanical system, then the model of computation may literally be the laws of physics. More commonly, however, it is a set of rules that are more abstract, and provide a framework within which a designer builds models. A set of rules that govern the interaction of components is called the *semantics* of the model of computation. A model of computation may have more than one semantics, in that there might be distinct sets of rules that impose identical constraints on behavior.

The choice of model of computation depends strongly on the type of model being constructed. For example, for a purely computational system that transforms a finite body of data into another finite body of data, the imperative semantics that is common in programming languages such as C, C++, Java, and Matlab will be adequate. For modeling a mechanical system, the semantics needs to be able to handle concurrency and the time continuum, in which case a continuous-time model of computation such that found in Simulink, Saber, Hewlett-Packard’s ADS, and VHDL-AMS is more appropriate.

The ability of a model to mutate into an implementation depends heavily on the model of computation that is used. Some models of computation, for example, are suitable for implementation only in customized hardware, while others are poorly matched to customized hardware because of their intrinsically sequential nature. Choosing an inappropriate model of computation may compromise the quality of design by leading the designer into a more costly or less reliable implementation.

A principle of the Ptolemy project is that the choices of models of computation strongly affect the quality of a system design.

For embedded systems, the most useful models of computation handle concurrency and time. This is because embedded systems consist typically of components that operate simultaneously and have multiple simultaneous sources of stimuli. In addition, they operate in a timed (real world) environment, where the timeliness of their response to stimuli may be as important as the correctness of the response.

The objective in Ptolemy II is to support the construction and interoperability of executable models that are built under a wide variety of models of computation.

Ptolemy II takes a component view of design, in that models are constructed as a set of interacting components. A model of computation governs the semantics of the interaction, and thus imposes a discipline on the interaction of components.

Component-based design in Ptolemy II involves disciplined interactions between components governed by a model of computation.

1.2 Architecture Design

Architecture description languages (ADLs), such as Wright [3] and Rapide [60], focus on formalisms for describing the rich sorts of component interactions that commonly arise in software architecture. Ptolemy II, by contrast, might be called an *architecture design language*, because its objective is not so much to describe existing interactions, but rather to promote coherent software architecture by imposing some structure on those interactions. Thus, while an ADL might focus on the compatibility of a sender and receiver in two distinct components, we would focus on a pattern of interactions among a set of components. Instead of, for example, verifying that a particular protocol in a single port-to-port interaction does not deadlock [3], we would focus on whether an assemblage of components can deadlock.

It is arguable that our approach is less modular, because components must be designed to the framework. Typical ADLs can describe pre-existing components, whereas in Ptolemy II, such pre-existing components would have to be wrapped in Ptolemy II actors. Moreover, designing components to a particular interface may limit their reusability, and in fact the interface may not match their needs well. All of these are valid points, and indeed a major part of our research effort is to ameliorate these limitations. The net effect, we believe, is an approach that is much more powerful than ADLs.

First, we design components to be *domain polymorphic*, meaning that they can interact with other components within a wide variety of domains. In other words, instead of coming up with an ADL that can describe a number of different interaction mechanisms, we have come up with an architecture where components can be easily designed to interact in a number of ways. We argue that this makes the components more reusable, not less, because disciplined interaction within a well-defined semantics is possible. By contrast, with pre-existing components that have rigid interfaces, the best we can hope for is ad-hoc synthesis of adapters between incompatible interfaces, something that is likely to lead to designs that are very difficult to understand and to verify. Whereas ADLs draw an analogy between compatibility of interfaces and type checking [3], we use a technique much more powerful than type checking alone, namely polymorphism [51].

Second, to avoid the problem that a particular interaction mechanism may not fit the needs of a component well, we provide a rich set of interaction mechanisms embodied in the Ptolemy II domains. The domains force component designers to think about the overall pattern of interactions, and trade off uniformity for expressiveness. Where expressiveness is paramount, the ability of Ptolemy II to hierarchically mix domains offers essentially the same richness of more ad-hoc designs, but with much more discipline. By contrast, a non-trivial component designed without such structure is likely to use a *melange*, or ad-hoc mixture of interaction mechanisms, making it difficult to embed it within a comprehensible system.

Third, whereas an ADL might choose a particular model of computation to provide it with a formal structure, such as CSP for Wright [3], we have developed a more abstract formal framework that describes models of computation at a meta level [55]. This means that we do not have to perform awkward translations to describe one model of computation in terms of another. For example, stream based communication via FIFO channels are awkward in Wright [3].

We make these ideas concrete by describing the models of computation implemented in the Ptolemy II domains.

1.3 Models of Computation

There is a rich variety of models of computation that deal with concurrency and time in different ways. Each gives an interaction mechanism for components. In this section, we describe models of computation that are implemented in Ptolemy II domains, plus a couple of additional ones that are planned. Our focus has been on models of computation that are most useful for embedded systems. All of these can lend a semantics to the same bubble-and-arc, or block-and-arrow diagram shown in figure 1.1. Ptolemy II models are (clustered, or hierarchical) graphs of the form of figure 1.1, where the nodes are *entities* and the arcs are *relations*. For most domains, the entities are *actors* (entities with functionality) and the relations connecting them represent communication between actors.

1.3.1 Communicating Sequential Processes - CSP

In the CSP domain (communicating sequential processes), created by Neil Smyth [86], actors represent concurrently executing processes, implemented as Java threads. These processes communicate by atomic, instantaneous actions called *rendezvous* (or sometimes, *synchronous message passing*). If two processes are to communicate, and one reaches the point first at which it is ready to communicate, then it stalls until the other process is ready to communicate. “Atomic” means that the two processes are simultaneously involved in the exchange, and that the exchange is initiated and completed in a single uninterruptable step. Examples of rendezvous models include Hoare’s *communicating sequential processes* (CSP) [40] and Milner’s *calculus of communicating systems* (CCS) [64]. This model of computation has been realized in a number of concurrent programming languages, including Lotos and Occam.

Rendezvous models are particularly well-matched to applications where resource sharing is a key element, such as client-server database models and multitasking or multiplexing of hardware resources. A key feature of rendezvous-based models is their ability to cleanly model nondeterminate interactions. The CSP domain implements both conditional send and conditional receive. It also includes an experimental timed extension.

1.3.2 Continuous Time - CT

In the CT domain (continuous time), created Jie Liu [57], actors represent components that interact via continuous-time signals. Actors typically specify algebraic or differential relations between inputs and outputs. The job of the director in the domain is to find a fixed-point, i.e., a set of continuous-time functions that satisfy all the relations.

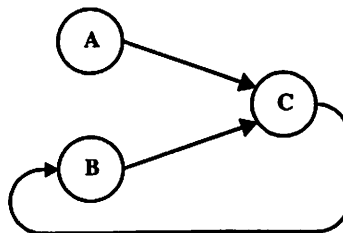

FIGURE 1.1. A single *syntax* (bubble-and-arc or block-and-arrow diagram) can have a number of possible *semantics* (interpretations).

The CT domain includes an extensible set of differential equation solvers. The domain, therefore, is useful for modeling physical systems with linear or nonlinear algebraic/differential equation descriptions, such as analog circuits and many mechanical systems. Its model of computation is similar to that used in Simulink, Saber, and VHDL-AMS, and is closely related to that in Spice circuit simulators.

Embedded systems frequently contain components that are best modeled using differential equations, such as MEMS and other mechanical components, analog circuits, and microwave circuits. These components, however, interact with an electronic system that may serve as a controller or a recipient of sensor data. This electronic system may be digital. Joint modeling of a continuous subsystem with digital electronics is known as *mixed signal modeling* [58]. The CT domain is designed to interoperate with other Ptolemy domains, such as DE, to achieve mixed signal modeling. To support such modeling, the CT domain models of discrete events as Dirac delta functions. It also includes the ability to precisely detect threshold crossings to produce discrete events.

Physical systems often have simple models that are only valid over a certain regime of operation. Outside that regime, another model may be appropriate. A *modal model* is one that switches between these simple models when the system transitions between regimes. The CT domain interoperates with the FSM domain to create modal models. Such modal models are often called *hybrid systems*.

1.3.3 Discrete-Events - DE

In the discrete-event (DE) domain, created by Lukito Muliadi [68], the actors communicate via sequences of events placed in time, along a real time line. An *event* consists of a *value* and *time stamp*. Actors can either be processes that react to events (implemented as Java threads) or functions that fire when new events are supplied. This model of computation is popular for specifying digital hardware and for simulating telecommunications systems, and has been realized in a large number of simulation environments, simulation languages, and hardware description languages, including VHDL and Verilog.

DE models are excellent descriptions of concurrent hardware, although increasingly the globally consistent notion of time is problematic. In particular, it over-specifies (or over-models) systems where maintaining such a globally consistent notion is difficult, including large VLSI chips with high clock rates. Every event is placed precisely on a globally consistent time line.

The DE domain implements a fairly sophisticated discrete-event simulator. DE simulators in general need to maintain a global queue of pending events sorted by time stamp (this is called a *priority queue*). This can be fairly expensive, since inserting new events into the list requires searching for the right position at which to insert it. The DE domain uses a calendar queue data structure [12] for the global event queue. A calendar queue may be thought of as a hashtable that uses quantized time as a hashing function. As such, both enqueue and dequeue operations can be done in time that is independent of the number of events in the queue.

In addition, the DE domain gives deterministic semantics to simultaneous events, unlike most competing discrete-event simulators. This means that for any two events with the same time stamp, the order in which they are processed can be inferred from the structure of the model. This is done by analyzing the graph structure of the model for data precedences so that in the event of simultaneous time stamps, events can be sorted according to a secondary criterion given by their precedence relationships. VHDL, for example, uses delta time to accomplish the same objective.

1.3.4 Distributed Discrete Events - DDE

The distributed discrete-event (DDE) domain, created by John Davis [21], can be viewed either as a variant of DE or as a variant of PN (described below). Still highly experimental, it addresses a key problem with discrete-event modeling, namely that the global event queue imposes a central point of control on a model, greatly limiting the ability to distribute a model over a network. Distributing models might be necessary either to preserve intellectual property, to conserve network bandwidth, or to exploit parallel computing resources.

The DDE domain maintains a local notion of time on each connection between actors, instead of a single globally consistent notion of time. Each actor is a process, implemented as a Java thread, that can advance its local time to the minimum of the local times on each of its input connections. The domain systematizes the transmission of null events, which in effect provide guarantees that no event will be supplied with a time stamp less than some specified value.

1.3.5 Discrete Time - DT

The discrete-time (DT) domain, written by Chamberlain Fong [25], extends the SDF domain (described below) with a notion of time between tokens. Communication between actors takes the form of a sequence of tokens where the time between tokens is uniform. Multirate models, where distinct connections have distinct time intervals between tokens, are also supported. There is considerable subtlety in this domain when multirate components are used. The semantics is defined so that component behavior is always causal, in that outputs whose values depend on inputs are never produced at times prior to those of the inputs.

1.3.6 Finite-State Machines - FSM

The finite-state machine (FSM) domain, written by Xiaojun Liu, is radically different from the other Ptolemy II domains. The entities in this domain represent not actors but rather *state*, and the connections represent *transitions* between states. Execution is a strictly ordered sequence of state transitions. The FSM domain leverages the built-in expression language in Ptolemy II to evaluate *guards*, which determine when state transitions can be taken.

FSM models are excellent for control logic. FSM models are amenable to in-depth formal analysis, and thus can be used to avoid surprising behavior.

FSM models have some key weaknesses. First, at a very fundamental level, they are not as expressive as the other models of computation described here. They are not sufficiently rich to describe all partial recursive functions. However, this weakness is acceptable in light of the formal analysis that becomes possible. Many questions about designs are decidable for FSMs and undecidable for other models of computation. A second key weakness is that the number of states can get very large even in the face of only modest complexity. This makes the models unwieldy.

Both problems can often be solved by using FSMs in combination with concurrent models of computation. This was first noted by David Harel, who introduced that Statecharts formalism. Statecharts combine a loose version of synchronous-reactive modeling (described below) with FSMs [34]. FSMs have also been combined with differential equations, yielding the so-called *hybrid systems* model of computation [36].

The FSM domain in Ptolemy II can be hierarchically combined with other domains. We call the resulting formalism “*charts” (pronounced “starcharts”) where the star represents a wildcard [31]. Since most other domains represent concurrent computations, *charts model concurrent finite state

machines with a variety of concurrency semantics. When combined with CT, they yield hybrid systems and modal models. When combined with SR (described below), they yield something close to State-charts. When combined with process networks, they resemble SDL [85].

1.3.7 Process Networks - PN

In the process networks (PN) domain, created by Mudit Goel [32], processes communicate by sending messages through channels that can buffer the messages. The sender of the message need not wait for the receiver to be ready to receive the message. This style of communication is often called asynchronous message passing. There are several variants of this technique, but the PN domain specifically implements one that ensures determinate computation, namely Kahn process networks [44].

In the PN model of computation, the arcs represent sequences of data values (tokens), and the entities represent functions that map input sequences into output sequences. Certain technical restrictions on these functions are necessary to ensure determinacy, meaning that the sequences are fully specified. In particular, the function implemented by an entity must be *prefix monotonic*. The PN domain realizes a subclass of such functions, first described by Kahn and MacQueen [45], where *blocking reads* ensure monotonicity.

PN models are loosely coupled, and hence relatively easy to parallelize or distribute. They can be implemented efficiently in both software and hardware, and hence leave implementation options open. A key weakness of PN models is that they are awkward for specifying control logic, although much of this awkwardness may be ameliorated by combining them with FSM.

The PN domain in Ptolemy II has a highly experimental timed extension. This adds to the blocking reads a method for stalling processes until time advances. We anticipate that this timed extension will make interoperation with timed domains much more practical.

1.3.8 Synchronous Dataflow - SDF

The synchronous dataflow (SDF) domain, created by Steve Neuendorffer, handles regular computations that operate on streams. Dataflow models, popular in signal processing, are a special case of process networks (for the complete explanation of this, see [54]). Dataflow models construct processes of a process network as sequences of atomic actor *firings*. Synchronous dataflow (SDF) is a particularly restricted special case with the extremely useful property that deadlock and boundedness are decidable. Moreover, the schedule of firings, parallel or sequential, is computable statically, making SDF an extremely useful specification formalism for embedded real-time software and for hardware.

Certain generalizations sometimes yield to similar analysis. Boolean dataflow (BDF) models sometimes yield to deadlock and boundedness analysis, although fundamentally these questions are undecidable. Dynamic dataflow (DDF) uses only run-time analysis, and thus makes no attempt to statically answer questions about deadlock and boundedness. Neither a BDF nor DDF domain has yet been written in Ptolemy II. Process networks (PN) serves in the interim to handle computations that do not match the restrictions of SDF.

1.3.9 Giotto

The Giotto domain, created by Christoph Meyer Kirsch, realizes a model of computation developed by Tom Henzinger, Christoph Meyer Kirsch, and Ben Horowitz. This domain has a time-triggered flavor, where each actor is invoked periodically with a specified period. The domain is designed to work with the FSM domain to realize modal models. It is intended for hard-real-time systems,

where resource allocation is precomputed.

1.3.10 Synchronous/Reactive - SR

In the synchronous/reactive (SR) model of computation [8], the arcs represent data values that are aligned with global clock ticks. Thus, they are discrete signals, but unlike discrete time, a signal need not have a value at every clock tick. The entities represent relations between input and output values at each tick, and are usually partial functions with certain technical restrictions to ensure determinacy. Examples of languages that use the SR model of computation include Esterel [10], Signal [9], Lustre [18], and Argos [61].

SR models are excellent for applications with concurrent and complex control logic. Because of the tight synchronization, safety-critical real-time applications are a good match. However, also because of the tight synchronization, some applications are overspecified in the SR model, limiting the implementation alternatives. Moreover, in most realizations, modularity is compromised by the need to seek a global fixed point at each clock tick. An SR domain has not yet been implemented in Ptolemy II, although the methods used by Stephen Edwards in Ptolemy Classic can be adapted to this purpose [22].

1.4 Choosing Models of Computation

The rich variety of concurrent models of computation outlined in the previous section can be daunting to a designer faced with having to select them. Most designers today do not face this choice because they get exposed to only one or two. This is changing, however, as the level of abstraction and domain-specificity of design software both rise. We expect that sophisticated and highly visual user interfaces will be needed to enable designers to cope with this heterogeneity.

An essential difference between concurrent models of computation is their modeling of time. Some are very explicit by taking time to be a real number that advances uniformly, and placing events on a time line or evolving continuous signals along the time line. Others are more abstract and take time to be discrete. Others are still more abstract and take time to be merely a constraint imposed by causality. This latter interpretation results in time that is partially ordered, and explains much of the expressiveness in process networks and rendezvous-based models of computation. Partially ordered time provides a mathematical framework for formally analyzing and comparing models of computation [55].

A grand unified approach to modeling would seek a concurrent model of computation that serves all purposes. This could be accomplished by creating a *melange*, a mixture of all of the above, but such a mixture would be extremely complex and difficult to use, and synthesis and simulation tools would be difficult to design.

Another alternative would be to choose one concurrent model of computation, say the rendezvous model, and show that all the others are subsumed as special cases. This is relatively easy to do, in theory. It is the premise of Wright, for example [3]. Most of these models of computation are sufficiently expressive to be able to subsume most of the others. However, this fails to acknowledge the strengths and weaknesses of each model of computation. Rendezvous is very good at resource management, but very awkward for loosely coupled data-oriented computations. Asynchronous message passing is the reverse, where resource management is awkward, but data-oriented computations are natural¹. Thus, to design interesting systems, designers need to use heterogeneous models.

1.5 Visual Syntaxes

Visual depictions of systems have always held a strong human appeal, making them extremely effective in conveying information about a design. Many of the domains of interest in the Ptolemy project use such depictions to completely and formally specify models.

One of the principles of the Ptolemy project is that visual depictions of systems can help to offset the increased complexity that is introduced by heterogeneous modeling.

These visual depictions offer an alternative *syntax* to associate with the semantics of a model of computation. Visual syntaxes can be every bit as precise and complete as textual syntaxes, particularly when they are judiciously combined with textual syntaxes.

Figures 1.2 and 1.3 show two different visual renditions of Ptolemy II models. Both renditions are constructed in Vergil, the visual editor framework in Ptolemy II. In figure 1.2, a Ptolemy II model is shown as a block diagram, which is an appropriate rendition for many discrete event models. In this particular example, records are constructed at the left by composing strings with integers representing

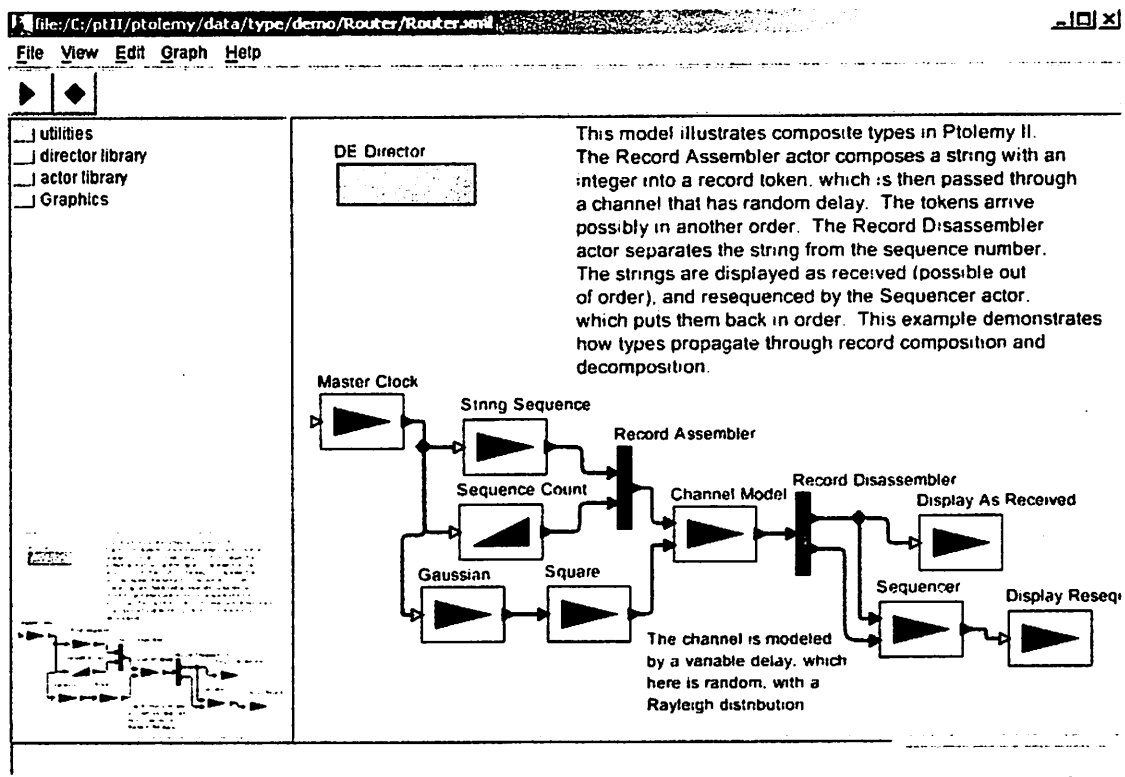

FIGURE 1.2. Visual rendition of a Ptolemy II model as a block diagram in Vergil (in the DE domain).

1. Consider the difference between the telephone (rendevous) and email (asynchronous message passing). If you are trying to schedule a meeting between four busy people, getting them all on a conference call would lead to a quick resolution of the meeting schedule. Scheduling the meeting by email could take several days, and may in fact never converge. Other sorts of communication, however, are far more efficient by email.

a sequence number. The records are launched into a network that introduces random delay. The records may arrive at the right out of order, but the Sequence actor is used to re-order them using the sequence number.

Figure 1.3 also shows a visual rendition of a Ptolemy II model, but now, the components are represented by circles, and the connections between components are represented by labeled arcs. This visual syntax is a familiar way to represent finite state machines (FSMs). Each circle represents a state of the model, and the arcs represent transitions between states. The particular example in the figure comes from a hybrid system model, where the two states, Separate and Together, represent two different modes of operation of a continuous-time system. The arcs are labeled with two lines, the first of which is a *guard*, and the second of which is an *action*. The guard is a boolean-valued expression that specifies when the transition should be taken, and the action is a sequence of commands that are executed when the transition is taken.

The visual renditions in figures 1.2 and 1.3 are both constructed using the same underlying infrastructure, Vergil, built by Stephen Neuendorffer. Vergil, in turn, is built on top of a GUI package called Diva, developed by John Reekie and Michael Shilman at Berkeley. Diva, in turn, is built on top of Swing and Java 2D, which are part of the Java platform from Sun Microsystems. In Vergil, a visual editor is constructed as an assembly of components in a Ptolemy II model. Thus, the system is configurable and customizable, and a great deal of infrastructure can be shared between the two distinct visual editors of figures 1.2 and 1.3.

Visual representations of models have a mixed history. In circuit design, schematic diagrams used to be routinely used to capture all of the essential information needed to implement some systems. Schematics are often replaced today by text in hardware description languages such as VHDL or Verilog. In other contexts, visual representations have largely failed, for example flowcharts for capturing the behavior of software. Recently, a number of innovative visual formalisms have been garnering support, including visual dataflow, hierarchical concurrent finite state machines, and object models. The UML visual language for object modeling has been receiving a great deal of attention. The static structure diagrams of UML, in fact, are used fairly extensively in the design of Ptolemy II itself (see appendix A of this chapter). Moreover, the Statecharts diagrams of UML are very similar to a hierarchical composition of the FSM and SR domains in Ptolemy II.

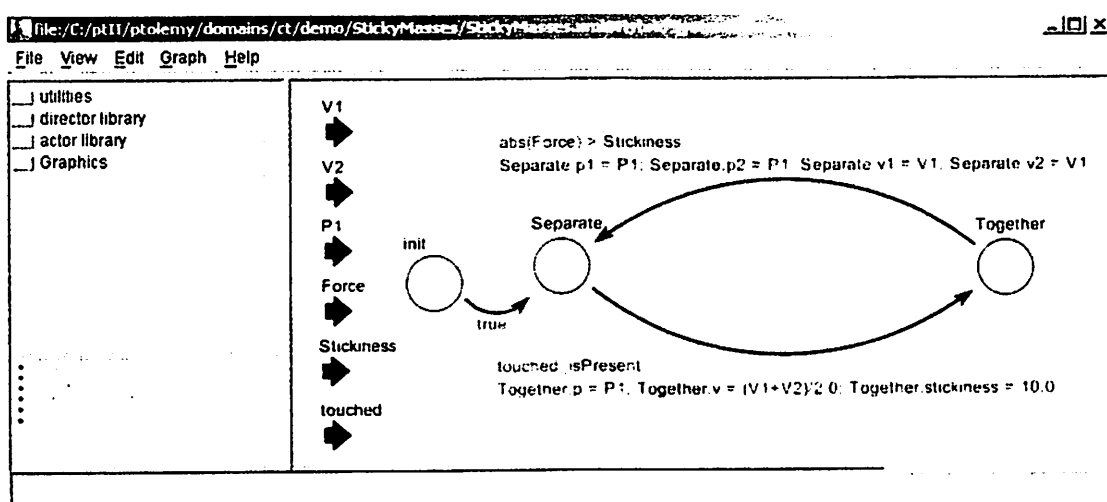

FIGURE 1.3. Visual rendition of a Ptolemy II model as a state transition diagram in Vergil (FSM domain).

A subset of visual languages that are recognizable as “block diagrams” represent concurrent systems. There are many possible concurrency semantics (and many possible models of computation) associated with such diagrams. Formalizing the semantics is essential if these diagrams are to be used for system specification and design. Ptolemy II supports exploration of the possible concurrency semantics. A principle of the project is that the strengths and weaknesses of these alternatives make them complementary rather than competitive. Thus, interoperability of diverse models is essential.

1.6 Ptolemy II Architecture

Ptolemy II offers a unified infrastructure for implementations of a number of models of computation. The overall architecture consists of a set of packages that provide generic support for all models of computation and a set of packages that provide more specialized support for particular models of computation. Examples of the former include packages that contain math libraries, graph algorithms, an interpreted expression language, signal plotters, and interfaces to media capabilities such as audio. Examples of the latter include packages that support clustered graph representations of models, packages that support executable models, and *domains*, which are packages that implement a particular model of computation.

Ptolemy II is modular, with a careful package structure that supports a layered approach. The *core packages* support the data model, or *abstract syntax*, of Ptolemy II designs. They also provide the *abstract semantics* that allows domains to interoperate with maximum information hiding. The *UI packages* provide support for our XML file format, called MoML, and a visual interface for constructing models graphically. The *library packages* provide actor libraries that are *domain polymorphic*, meaning that they can operate in a variety of domains. And finally, the *domain packages* provide domains, each of which implements a model of computation, and some of which provide their own, domain-specific actor libraries.

1.6.1 Core Packages

The core packages are shown in figure 1.4. This is a UML package diagram. The name of each package is in the tab at the top of each box. Subpackages are contained within their parent package. Dependencies between packages are shown by dotted lines with arrow heads. For example, *actor* depends on *kernel* which depends on *kernel.util*. *Actor* also depends on *data* and *graph*. The role of each package is explained below.

- | | |
|----------------------|---|
| actor | This package supports executable entities that receive and send data through ports. It includes both untyped and typed actors. For typed actors, it implements a sophisticated type system that supports polymorphism. It includes the base class Director that is extended in domains to control the execution of a model. |
| actor.process | This subpackage provides infrastructure for domains where actors are processes implemented on top of Java threads. |
| actor.sched | This subpackage provides infrastructure for domains where actors are statically scheduled by the director, or where there is static analysis of the topology of a model associated with scheduling. |
| actor.util | This subpackage contains utilities that support directors in various domains. Specifically, it contains a simple FIFO Queue and a sophisticated priority queue called a calendar queue. |
| data | This package provides classes that encapsulate and manipulate data that is trans- |

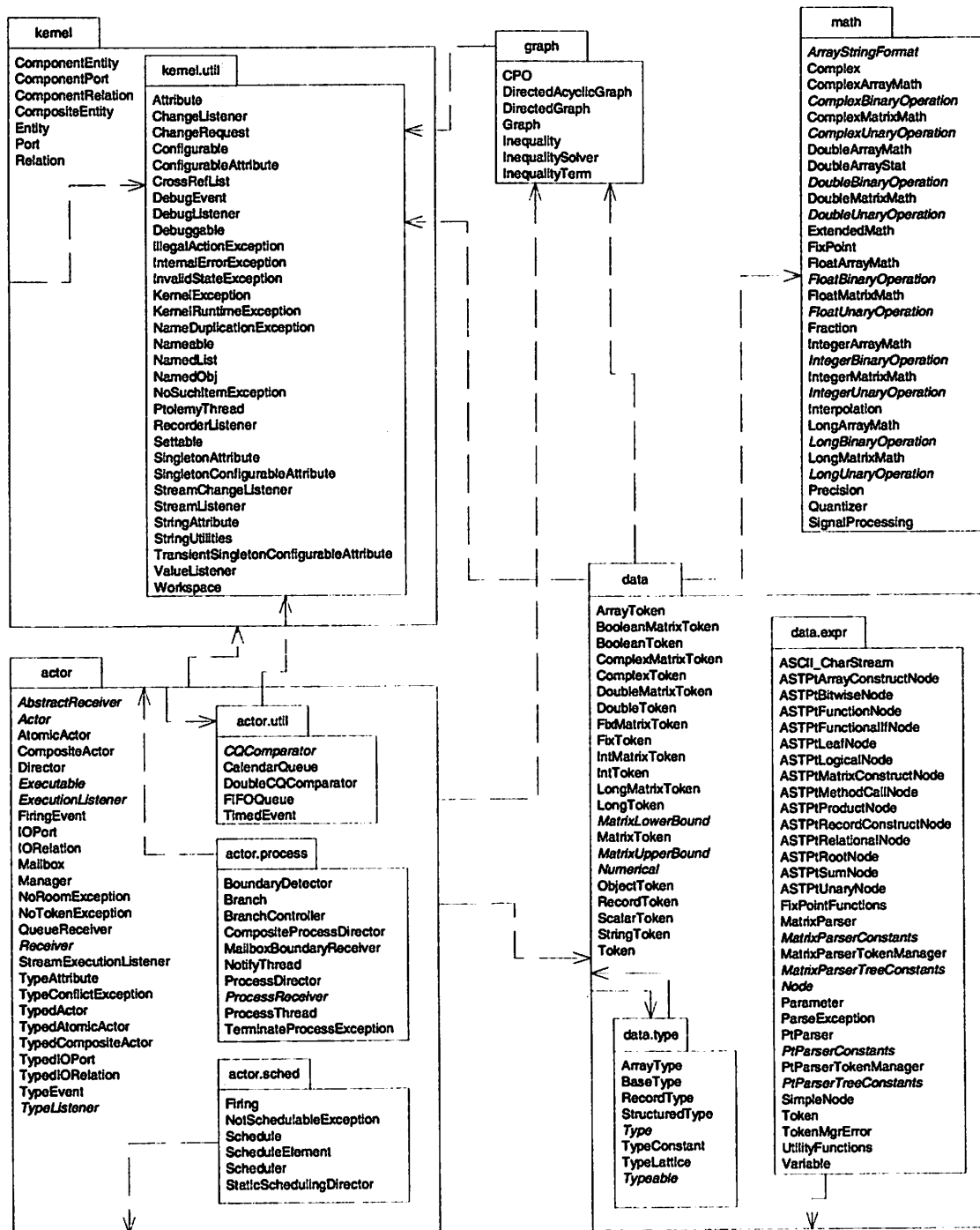

FIGURE 1.4. The core packages shown here support the data model, or abstract syntax, of Ptolemy II designs. They also provide the abstract semantics that allows domains to interoperate with maximum information hiding.

	ported between actors in Ptolemy models. The key class is the Token class, which defines a set of polymorphic methods for operating on tokens, such as add(), subtract(), etc.
data.expr	This class supports an extensible expression language and an interpreter for that language. Parameters can have values specified by expressions. These expressions may refer to other parameters. Dependencies between parameters are handled transparently, as in a spreadsheet, where updating the value of one will result in the update of all those that depend on it.
data.type	This package contains classes and interfaces for the type system.
graph	This package provides algorithms for manipulating and analyzing mathematical graphs. This package is expected to supply a growing library of algorithms. These algorithms support scheduling and analysis of Ptolemy II models.
kernel	This package provides the software architecture for the Ptolemy II data model, or <i>abstract syntax</i> . This abstract syntax has the structure of clustered graphs. The classes in this package support <i>entities</i> with <i>ports</i> , and <i>relations</i> that connect the ports. Clustering is where a collection of entities is encapsulated in a single <i>composite entity</i> , and a subset of the ports of the inside entities are exposed as ports of the composite entity.
kernel.util	This subpackage of the kernel package provides a collection of utility classes that do not depend on the kernel package. It is separated into a subpackage so that these utility classes can be used without the kernel. The utilities include a collection of exceptions, classes supporting named objects with attributes, lists of named objects, a specialized cross-reference list class, and a thread class that helps Ptolemy keep track of executing threads.
math	This package encapsulates mathematical functions and methods for operating on matrices and vectors. It also includes a complex number class, a class supporting fractions, and a set of classes supporting fixed-point numbers.

1.6.2 Overview of Key Classes

Some of the key classes in Ptolemy II are shown in figure 1.5. This is a UML static structure diagram (see appendix A of this chapter). The key syntactic elements are boxes, which represent classes, the hollow arrow, which indicates generalization (or subclassing), and other lines, which indicate associations. Some lines have a small diamond, which indicates aggregation. The details of these classes will be discussed in subsequent chapters.

Instances of all of the classes shown can have names; they all implement the Nameable interface. Most of the classes generalize NamedObj, which in addition to being nameable can have a list of attributes associated with it. Attributes themselves are instances of NamedObj.

Entity, Port, and Relation are three key classes that extend NamedObj. These classes define the primitives of the abstract syntax supported by Ptolemy II. They are fully explained in the kernel chapter. ComponentPort, ComponentRelation, and ComponentEntity extend these classes by adding support for clustered graphs. CompositeEntity extends ComponentEntity and represents an aggregation of instances of ComponentEntity and ComponentRelation.

The Executable interface, explained in the actors chapter, defines objects that can be executed. The Actor interface extends this with capability for transporting data through ports. AtomicActor and CompositeActor are concrete classes that implement this interface. The Executable and Actor interfaces are

key to the Ptolemy II abstract semantics.

An executable Ptolemy II model consists of a top-level CompositeActor with an instance of Director and an instance of Manager associated with it. The manager provides overall control of the execution (starting, stopping, pausing). The director implements a semantics of a model of computation to govern the execution of actors contained by the CompositeActor.

Director is the base class for directors that implement models of computation. Each such director is associated with a domain. We have defined in Ptolemy II directors that implement continuous-time modeling (ODE solvers), process networks, synchronous dataflow, discrete-event modeling, and communicating sequential processes.

1.6.3 Domains

The domains in Ptolemy II are subpackages of the `ptolemy.domains` package, as shown in figure 1.6. These packages generally contain a kernel subpackage, which defines classes that extend those in

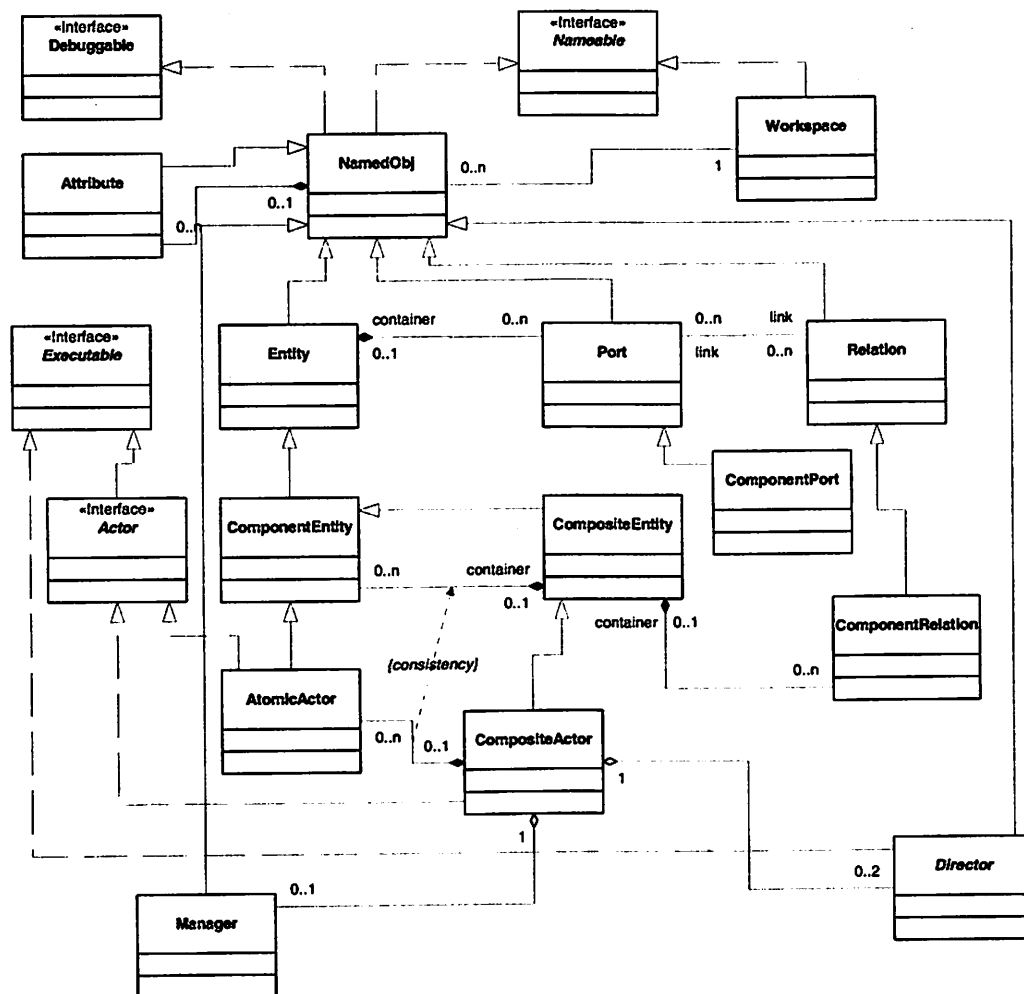

FIGURE 1.5. Some of the key classes in Ptolemy II. These are defined in the *kernel*, *kernel.util*, and *actor* packages. They define the Ptolemy II abstract syntax and abstract semantics.

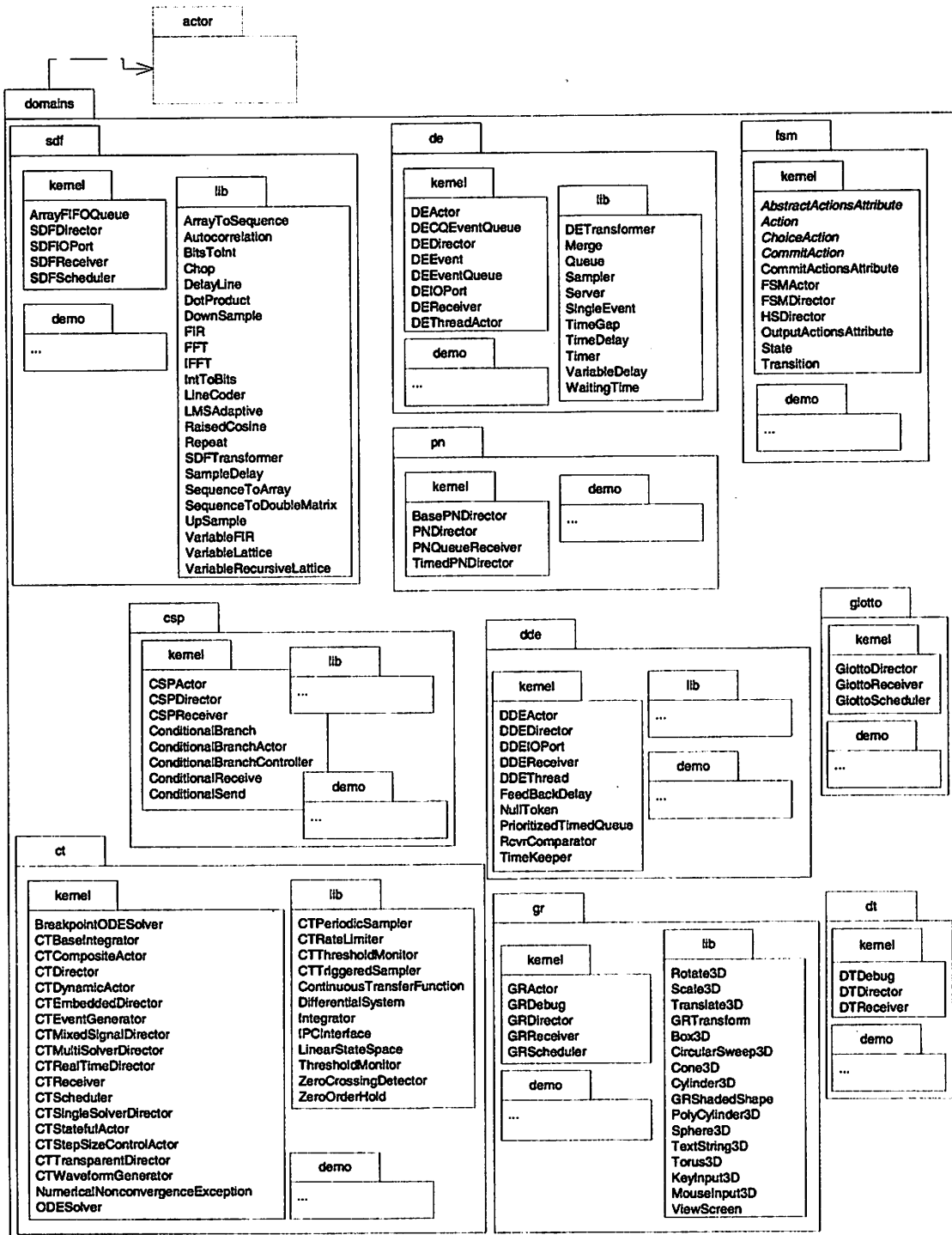

FIGURE 1.6. Package structure of Ptolemy II domains.

the actor or kernel packages of Ptolemy II. The lib subpackage, when it exists, includes domain-specific actors.

1.6.4 Library Packages

Most domains extend classes in the actor package to give a specific semantic interpretation to an interconnection of actors. It is possible, and strongly encouraged, to define actors in such a way that they can operate in multiple domains. Such actors are said to be *domain polymorphic*. Actor that are domain polymorphic are organized in the packages shown in figure 1.7. These packages are briefly

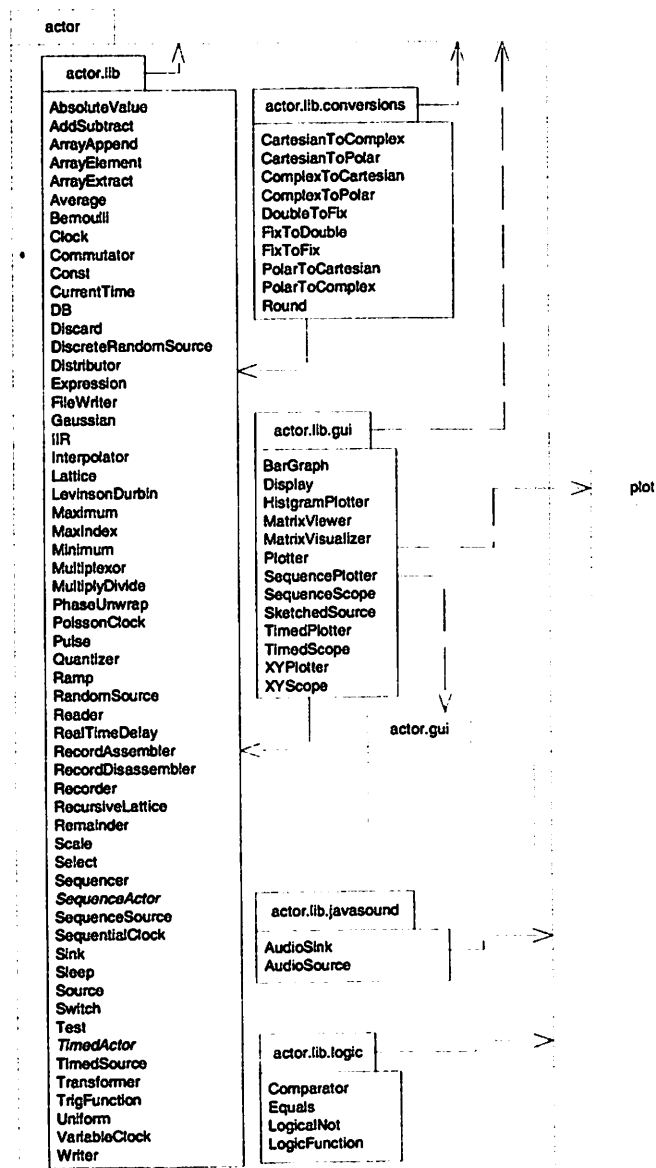

FIGURE 1.7. Packages containing domain-polymorphic actors.

described below:

- actor.lib** This subpackage is the main library of polymorphic actors. Eventually, this package will be reorganized into subpackages.
- actor.lib.gui** This subpackage is a library of polymorphic actors with user interface components, such as plotters.
- actor.lib.conversions**
This subpackage provides domain polymorphic actors that convert data between different types.
- actor.lib.javasound**
This package provides sound actors on systems that are running Java 1.3 or later.
- actor.lib.logic** This subpackage provides actors that perform logical functions like AND, OR and NOT.

1.6.5 User Interface Packages

The UI packages provide support for our XML file format, called MoML, and a visual interface for constructing models graphically, called Vergil. These packages are organized as shown in figure 1.8. The intent of each package is described below:

- actor.gui** This subpackage contains the configuration infrastructure, which supports modular construction of user interfaces that are themselves Ptolemy II models.
- actor.gui.style** This package contains classes that decorate attributes to serve as hints to a user interface about how to present these attributes to the user.
- gui** This package contains generically useful user interface components.
- media** This package encapsulates a set of classes supporting audio and image processing.
- moml** This package contains classes support our XML modeling markup language (MoML), which is used to describe Ptolemy II models.
- plot** This package and its subpackages provides two-dimensional signal plotting widgets.
- vergil** This package and its subpackages contains the Ptolemy II graphical user interface

1.6.6 Capabilities

Ptolemy II is a second generation system. Its predecessor, Ptolemy Classic, still has many active users and developers, and may continue to evolve for some time. Ptolemy II has a somewhat different emphasis, and through its use of Java, concurrency, and integration with the network, is aggressively experimental. Some of the major capabilities in Ptolemy II that we believe to be new technology in modeling and design environments include:

- *Higher level concurrent design in JavaTM*. Java support for concurrent design is very low level, based on threads and monitors. Maintaining safety and liveness can be quite difficult [47]. Ptolemy II includes a number of domains that support design of concurrent systems at a much higher level of abstraction, at the level of their software architecture. Some of these domains use Java threads

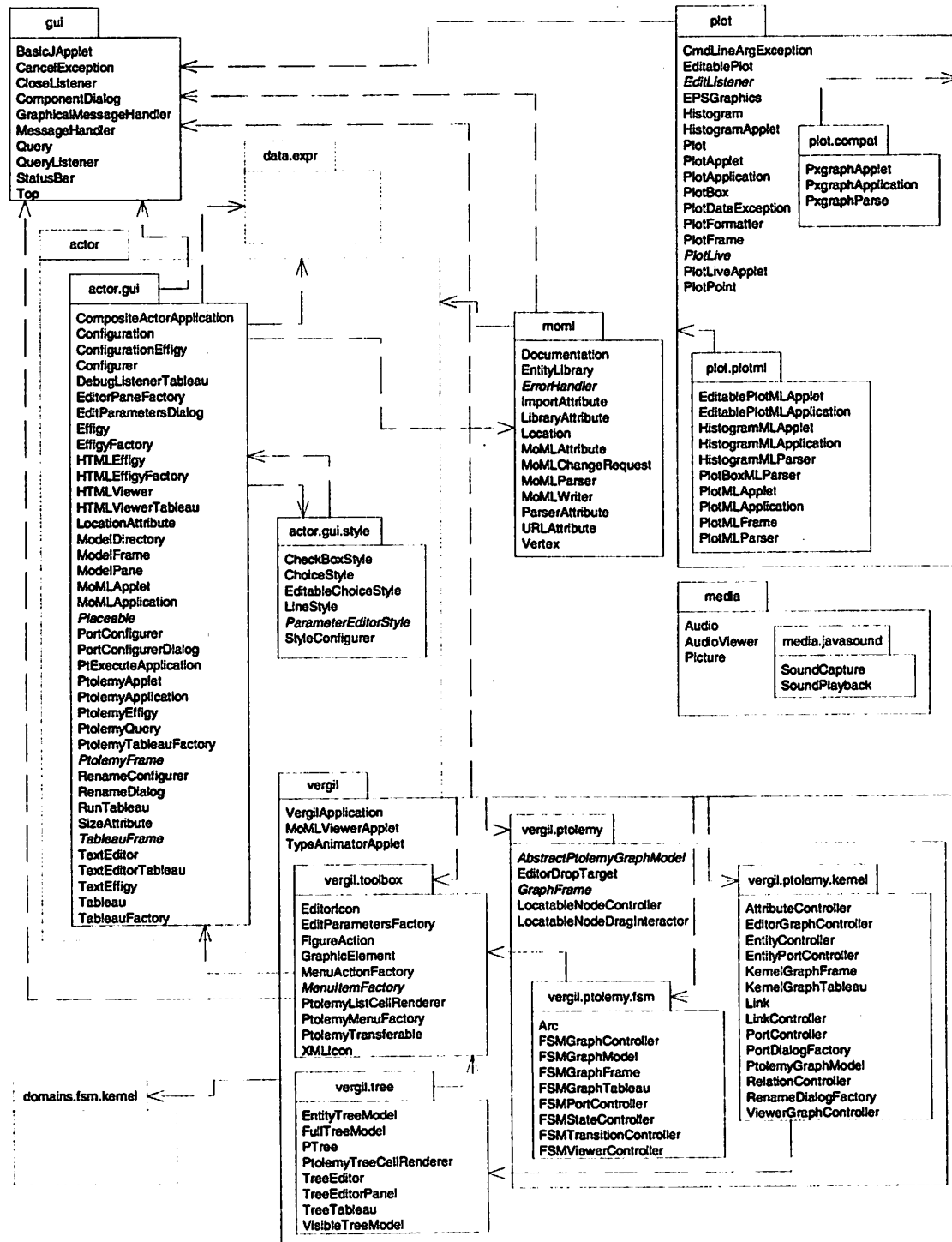

FIGURE 1.8. Packages in Ptolemy II that support user interfaces, including the MoML XML schema and the Vergil visual editor.

as an underlying mechanism, while others offer an alternative to Java threads that is much more efficient and scalable.

- *Better modularization through the use of packages.* Ptolemy II is divided into packages that can be used independently and distributed on the net, or drawn on demand from a server. This breaks with tradition in design software, where tools are usually embedded in huge integrated systems with interdependent parts.
- *Complete separation of the abstract syntax from the semantics.* Ptolemy designs are structured as clustered graphs. Ptolemy II defines a clean and thorough abstract syntax for such clustered graphs, and separates into distinct packages the infrastructure supporting such graphs from mechanisms that attach semantics (such as dataflow, analog circuits, finite-state machines, etc.) to the graphs.
- *Improved heterogeneity via a well-defined abstract semantics.* Ptolemy Classic provided a worm-hole mechanism for hierarchically coupling heterogeneous models of computation. This mechanism is improved in Ptolemy II through the use of opaque composite actors, which provide better support for models of computation that are very different from dataflow, the best supported model in Ptolemy Classic. These include hierarchical concurrent finite-state machines and continuous-time modeling techniques.
- *Thread-safe concurrent execution.* Ptolemy models are typically concurrent, but in the past, support for concurrent execution of a Ptolemy model has been primitive. Ptolemy II supports concurrency throughout, allowing for instance for a model to mutate (modify its clustered graph structure) while the user interface simultaneously modifies the structure in different ways. Consistency is maintained through the use of monitors and read/write semaphores [40] built upon the lower level synchronization primitives of Java.
- *A software architecture based on object modeling.* Since Ptolemy Classic was constructed, software engineering has seen the emergence of sophisticated object modeling [63][80][83] and design pattern [28] concepts. We have applied these concepts to the design of Ptolemy II, and they have resulted in a more consistent, cleaner, and more robust design. We have also applied a simplified software engineering process that includes systematic design and code reviews [78].
- *A truly polymorphic type system.* Ptolemy Classic supported rudimentary polymorphism through the “anytype” particle. Even with such limited polymorphism, type resolution proved challenging, and the implementation is ad-hoc and fragile. Ptolemy II has a more modern type system based on a partial order of types and monotonic type refinement functions associated with functional blocks. Type resolution consists of finding a fixed point, using algorithms inspired by the type system in ML [66]. The type system is described in [91].
- *Domain-polymorphic actors.* In Ptolemy Classic, actor libraries were separated by domain. Through the notion of subdomains, actors could operate in more than one domain. In Ptolemy II, this idea is taken much further. Actors with intrinsically polymorphic functionality can be written to operate in a much larger set of domains. The mechanism they use to communicate with other actors depends on the domain in which they are used. This is managed through a concept that we call a *process level type system*.
- *Extensible XML-based file formats.* XML is an emerging standard for representation of information that focuses on the logical relationships between pieces of information. Human-readable representations are generated with the help of style sheets. Ptolemy II will use XML as its primary format for persistent design data.

1.6.7 Future Capabilities

Capabilities that we anticipate making available in the future include:

- *Interoperability through software components.* Ptolemy II will use distributed software component technology such as CORBA, Java RMI, or DCOM, in a number of ways. Components (actors) in a Ptolemy II model will be implementable on a remote server. Also, components may be parameterized where parameter values are supplied by a server (this mechanism supports *reduced-order modeling*, where the model is provided by the server). Ptolemy II models will be exported via a server. And finally, Ptolemy II will support migrating software components.
- *Code generation.* Ptolemy II has an evolving code generation mechanism that is very different from that in Ptolemy Classic. In Ptolemy Classic, each component has to have a definition in the target language, and the code generator merely stitches together these components. In Ptolemy II, components are defined in Java, and the Java definition is parsed. An API for performing optimization transformations on the abstract syntax tree is defined, and then compiler back ends can be used to generate target code. A preliminary implementation of this approach is described in [87] and [88].
- *Integrated verification tools.* Modern verification tools based on model checking [37] could be integrated with Ptolemy II at least to the extent that finite state machine models can be checked. We believe that the separation of control logic from concurrency will greatly facilitate verification, since only much smaller cross-sections of the system behavior will be offered to the verification tools.
- *Reflection of dynamics.* Java supports reflection of static structure, but not of dynamic properties of process-based objects. For example, the data layout required to communicate with an object is available through the reflection package, but the communication protocol is not. We plan to extend the notion of reflection to reflect such dynamic properties of objects.
- *Meta modeling.* The domains in Ptolemy II are constructed based on an intuitive understanding of a useful class of modeling techniques, and then the support infrastructure for specifying and executing models in the domain are built by hand by writing Java code. Others have built tools that have the potential of improving on this situation by *meta modeling*. In Dome (from Honeywell) and GME (from Vanderbilt), for example, a modeling strategy itself is modeled, and user interfaces supporting that modeling strategy are synthesized from that model. We can view the current component-based architecture of Vergil as a starting point in this direction. In the future, we expect to see much more use of Ptolemy II itself to define and construct Ptolemy II domains and their user interfaces.

Appendix A: UML — Unified Modeling Language

UML (the unified modeling language) [26][77] defines a suite of visual syntaxes for describing various aspects of software architecture. We make heavy use of two of these visual syntaxes, package diagrams and static structure diagrams. These syntaxes are summarized here. As with most descriptive syntaxes, any use of the syntax involves certain stylistic choices. These stylistic choices are not part of UML, but nonetheless can be important to understanding the diagrams. We explain the style that we use here.

A.1 Package Diagrams

Figures 1.4 and 1.6 show UML *package diagrams*, which have a simple syntax. A package is given as a box with a tab, with the tab containing the name of the package. Subpackages are enclosed in the box of the parent package, and package dependencies are indicated with arrows. A package dependency occurs when a Java file in a package includes a class in another package (using `import` in Java).

A.2 Static Structure Diagrams

Figure 1.5 is a different kind of UML diagram, called a *static structure diagram* or *class diagram*. It represents the relationships between classes, including inheritance relationships, containment relationships, and cross references. These relationships are called an *object model*, and represent many essential features about the design.

A.2.1 Classes

A simplified static structure diagram for some Ptolemy II classes is shown in figure 1.9. In this diagram, each class is shown in a box. The class name is at the top of each box, its *attributes* are below that, and its methods below that. Thus, each box is divided into three segments separated by horizontal lines. The attributes are members of the Java classes, which may be public, package friendly, protected, or private. Private members are prefixed by a minus sign “-”, as for example the `_container` attribute of `Port`. Although private members are not visible directly to users of the class, they may nonetheless be a useful part of the object model because they indicate the state information contained by an instance of the class. Public members have a leading “+” and protected methods a leading “#” in a UML diagram. There are no public or protected members shown in figure 1.9. The type of a member is indicated after a colon, so for example, the `_container` method of `Port` is of type `Entity`.

Methods, which are shown below attributes, also have a leading “+” for public, “#” for protected, and “-” for private. Our object models do not show private methods, since they are not inherited and are not visible in the interface to the object. Figure 1.9 shows a number of public methods and one protected method, `_link()` in `Port`. The return value of a method is given after a colon, so for example, `getContainer()` of `Port` returns an `Entity`.

Although not usually included in UML diagrams, our diagrams show class constructors. They are listed first among the methods and have names that are the same as the name of the class. No return type is shown. For completeness, our object models typically show all public and protected methods of these classes, although a proper object model might only show those relevant to the issues being discussed. Figure 1.9 does not show all methods, so that we can simplify the discussion of UML. Our dia-

grams do not include deprecated methods or methods that are present in parent classes.

Arguments to a method or constructor are shown in parentheses, with the types after a colon, so for example, `ComponentEntity` shows a single constructor that takes two arguments, one of type `CompositeEntity` and the other of type `String`.

A.2.2 Inheritance

Subclasses are indicated by lines with white triangles (or outlined arrow heads). The class on the side of the arrow head is the *superclass* or *base class*. The class on the other end is the *subclass* or *derived class*. The derived class is said to *specialize* the base class, or conversely, the base class to *generalize* the derived class. The derived class *inherits* all the methods shown in the base class and may *override* or some of them. In our object models, we do not explicitly show methods that override those defined in a base class or are inherited from a base class. For example, in figure 1.9, `ComponentEntity` has all the methods of `Entity` and `NamedObj`, and may override some of those methods, but only shows

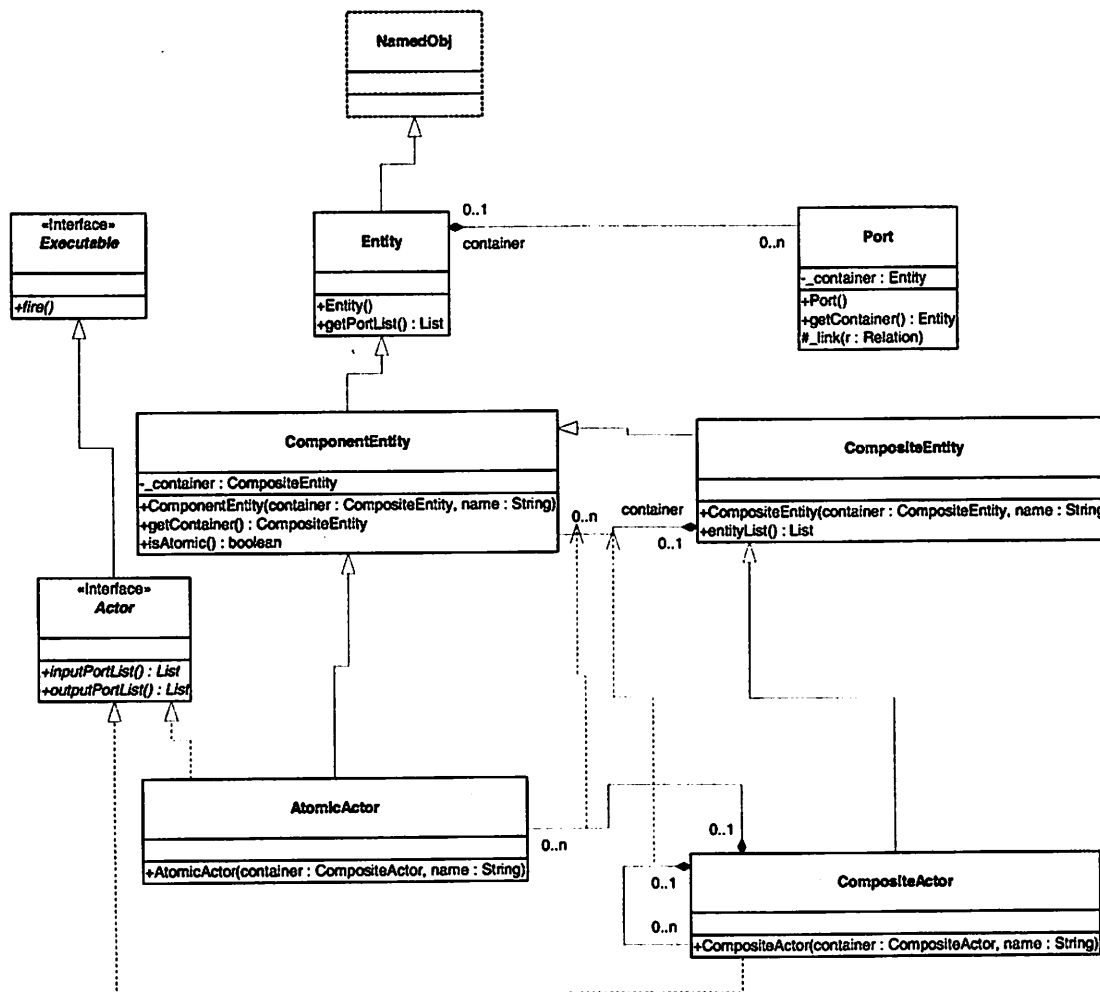

FIGURE 1.9. Simplified static structure diagram for some Ptolemy II classes. This diagram illustrates features of UML syntax that we use.

the one method it adds. Thus, the complete set of methods of a class is cumulative. Every class has its own methods plus those of all its superclasses.

An exception to this is constructors. In Java, constructors are not inherited. Thus, in our class diagrams, the only constructors available for a class are those shown in the box defining the class. Figure 1.9 does not show all the constructors of these classes, for simplicity.

Classes shown in boxes outlined with dashed lines, such as NamedObj in figure 1.9, are fully described elsewhere. This is not standard UML notation, but it gives us a convenient way to partition diagrams. Often, these classes belong to another package.

A.2.3 Interfaces

Figure 1.9 also shows two examples of *interfaces*, Executable and Actor. An interface is indicated by the label “<<Interface>>” and by italics in the name. An interface defines a set of methods without providing an implementation for them. It cannot be instantiated, and therefore has no constructors. When a class *implements* an interface, the object model shows the relationship with a dotted-line with an arrow. Any *concrete class* (one that can be instantiated) that implements an interface must provide implementations of all its methods. In our object models, we do not show those methods explicitly in the concrete class, just like inherited methods, but their presence is implicit in the relationship to the interface.

One interface can extend another. For example, in figure 1.9, Actor extends Executable. This means that any concrete class that implements Actor must implement the methods of Actor and Executable.

We will occasionally show *abstract classes*, which are like interfaces in that they cannot be instantiated, but unlike interfaces in that they may provide default implementations for some methods and may even have private members. Abstract classes are indicated by italics in the class name. There are no abstract classes in figure 1.9.

A.2.4 Associations

Inheritance and implementation are types of *associations* between entities in the object model. Associations of other types are indicated by other lines, often annotated with ranges like “0..n” or with diamonds on one end or the other.

Aggregations are shown as associations with diamonds. For example, an Entity is an aggregation of any number (0..n) instances of Port. More strongly, we say that a Port is *contained* by 0 or 1 instances of Entity. By containment, we mean that a port can only be contained by a single Entity. In a weaker form of aggregation, more than one aggregate may refer to the same component. The stronger form of aggregation (containment) is indicated by the filled diamond, while the weaker form is indicated by the unfilled diamond. There are no unfilled diamonds in figure 1.9. In fact, they are fairly rare in Ptolemy II, since many of its architectural features depend on containment relationships, where an object can have at most one container.

The relationship between ComponentEntity and CompositeEntity is particularly interesting. An instance of CompositeEntity can contain any number of instances of ComponentEntity, but CompositeEntity is derived from ComponentEntity. Thus, a CompositeEntity can contain any number of instances of either ComponentEntity or CompositeEntity. This is the classic Composite design pattern [28], which supports arbitrarily deeply nested containment hierarchies.

In figure 1.9, a CompositeActor is an aggregation of AtomicActors and CompositeActors. These

two aggregation relations are derived from the aggregation relationship between ComponentEntity and CompositeEntity. This derived association is indicated with a dashed line with an open arrowhead.

Appendix B: Ptolemy II Naming Conventions

We have made an effort to be consistent about naming of classes, methods and members. This appendix describes our policy.

B.1 Classes

Class names are capitalized with internal word boundaries also capitalized (as in “CompositeEntity”). Most names are made up of complete words (“CompositeEntity” rather than “CompEnt”)¹. Interface names suggest their potential (as in “Executable,” which means “can be executed”).

Despite having packages to divide up the namespace, we attempt nonetheless to keep class names unique. This helps avoid confusion and bugs that may arise from having Java import statements in the wrong order. In many cases, a domain includes a specialized version of some more generic class. In this case, we create a unique name by prefixing the generic name with the domain name. For example, while Director is a base class in the actor package, DEDirector is a derived class in the DE domain.

For the most part, we try to avoid prefixing actor names with the domain name. e.g., we define Delay rather than DEDelay. Occasionally however, the domain prefix is useful to distinguish two versions of some similar functionality, both of which might be useful in a domain. For example, the DE domain can use actors derived from Transformer or from DETransformer, where the latter is specialized to DE.

B.2 Members

Member names are not capitalized, although internal word boundaries usually are (e.g. “declaredType”). If the member is private or protected, then its name begins with a leading underscore (e.g. “_declaredType”).

B.3 Methods

Method names are similar to member names, in that they are not capitalized, except on internal word boundaries. Private and protected methods have a leading underscore. In text referring to methods, the method name is followed by open and close parentheses, as in “getName()”. Usually, no arguments are given, even if the method takes arguments.

Method names that are plural, such as insideRelations(), usually return an enumeration (or sometimes an array, or an iterator). Methods that return Lists are usually of the form portList().

1. There are some (perhaps regrettable) exceptions to this, such as NamedObj.

The first part of the book is devoted to the study of the

of the various forms of the verb and the

Example 1.1

The second part of the book is devoted to the study of the

Example 1.2

The third part of the book is devoted to the study of the

Example 1.3

The fourth part of the book is devoted to the study of the

Example 1.4

The fifth part of the book is devoted to the study of the

Example 1.5

The sixth part of the book is devoted to the study of the

Example 1.6

2

Using Vergil

Authors: Steve Neuendorffer

2.1 Introduction

Vergil is the Graphical User Interface for Ptolemy II. This chapter will guide you through using Vergil to create and manipulate Ptolemy models. Figure 2.1 shows a simple Ptolemy II model in Vergil, showing the graph editor, one of several editors available in Vergil.

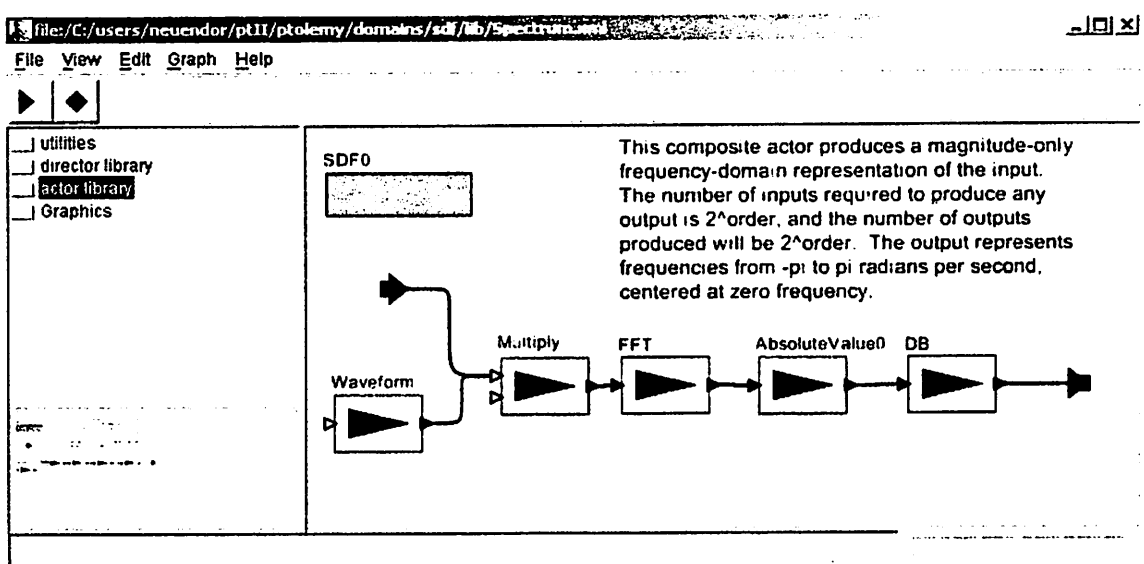

FIGURE 2.1. Example of a Vergil window.

2.2 Quick Start

The traditional first programming example is Hello World. Why break tradition?

First start Vergil. From the command line, enter “vergil”, or select Vergil from the Start menu. You should see a welcome screen that looks like the one in figure 2.2. Feel free to explore the links in this window. Most useful is probably the “Quick tour” link.

Create a new graph editor from the File->New menu in the welcome window. You should see something like the window shown in Figure 2.3. Ignoring the menus and toolbar for a moment, on the left is a palette of objects that can be dragged onto the page on the right. To begin with, the page on the right is blank. Open the *actor library* in the palette, and go into the *sources* library. Find the *Const* actor and drag an instance over onto the blank page. Then go into the *sinks* library and drag a *Display* actor onto the page. Each of these actors can be dragged around on the page. However, we would like to connect one to the other. To do this, drag a connection from the output port on the right of the *Const* actor to the input port of the *Display* actor. Lastly, open the *director library* and drag an *SDFDirector* onto the page. The Director gives an execution meaning to the graph, but for now we don't have to be concerned about exactly what that is.

Now you should have something that looks like Figure 2.4. The *Const* actor is going to create our string, and the *Display* actor is going to print it out for us. We need to take care of one small detail before we run our example: we need to tell the *Const* actor that we want the string “Hello World”. To do this we need to edit one of the parameters of the *Const*. To do this, right click on the *Const* actor and select “Edit Parameters”. You should see the dialog box in figure 2.5. Enter the string “Hello World” for the value parameter and click the Commit button. Be sure to include the double quotes, so that the expression is interpreted as a string.

To run the example, go to the View menu and select the Run Window. If you click the “Go” button, you will see a large number of strings in the Display at the right. To stop the execution, click the “Stop” button. To see only one string, change the iterations parameter of the director to 1, which can be done

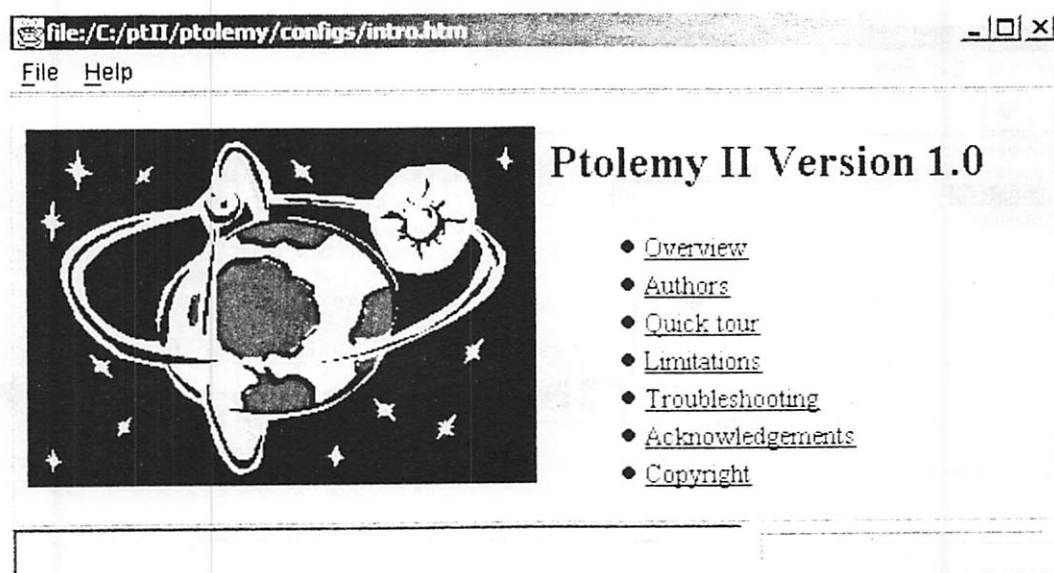

FIGURE 2.2. Welcome window.

in the run window, or in the graph editor in the same way you edited the parameter of the *Const* actor before. The run window is shown in Figure 2.6.

2.3 Data Types and the Type System

So what is really going on here? The *Const* actor is creating values on its output port. The *Display* actor is consuming data values from its input port and displaying them in the run window. The value that is created by the *Const* actor can be any type of object. For example, try giving the value 1 (the integer with value one), or 1.0 (the floating point number with value one), or {1.0} (An array containing a one), or {value=1, name="one"} (A record of two elements: an integer named value and a string named name), or even [1,1;1,1] (a two by two matrix). They all seem pretty much the same in the Display, but Ptolemy knows the difference between them! To see the difference, try creating the model in Figure 2.7. The *Ramp* actor is listed under *sources* and the *AddSubtract* actor is listed under *math*. Set

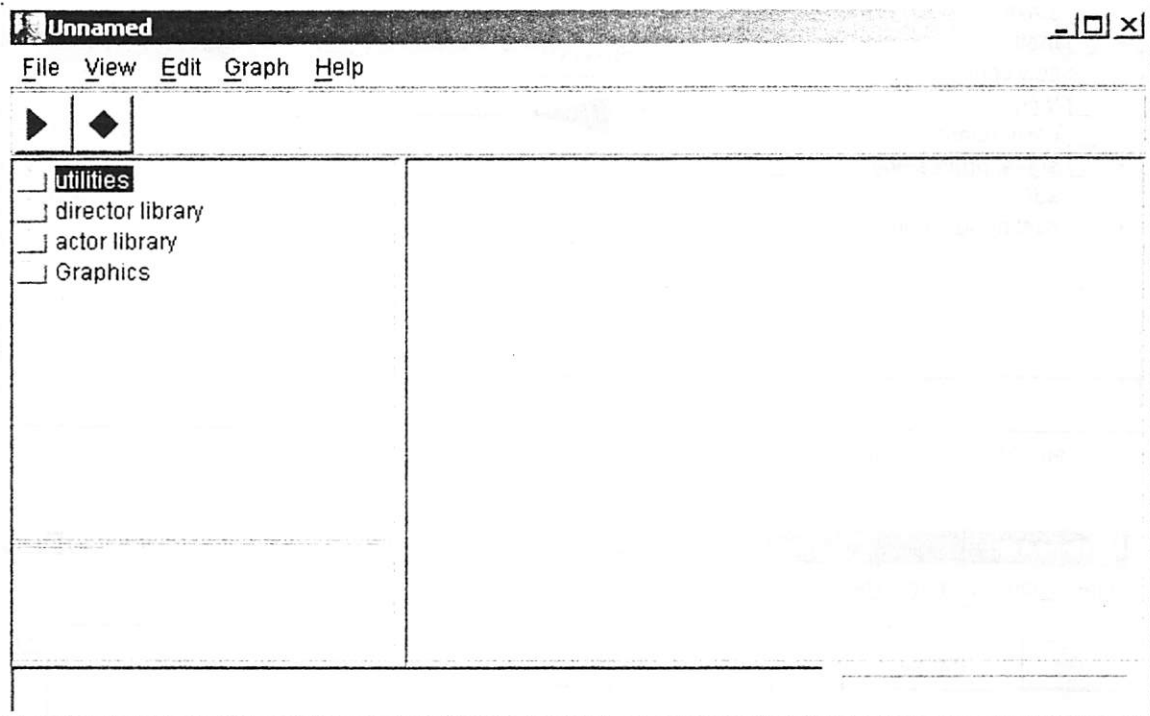

FIGURE 2.3. An empty Vergil Graph Editor.

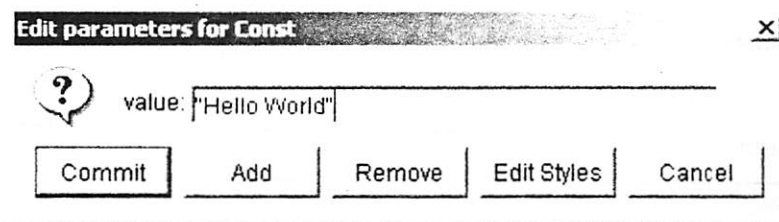

FIGURE 2.5. The Const parameter editor.

the *value* parameter of the constant to be 0 and the *iterations* parameter of the director to 5. Running the model should result in 5 numbers between 0 and 4. These are the values produced by the *Ramp*, which are having the value of the *Const* actor subtracted from them. Experiment with changing the value of the *Const* actor and see how it changes the 5 numbers at the output. Now for the real test:

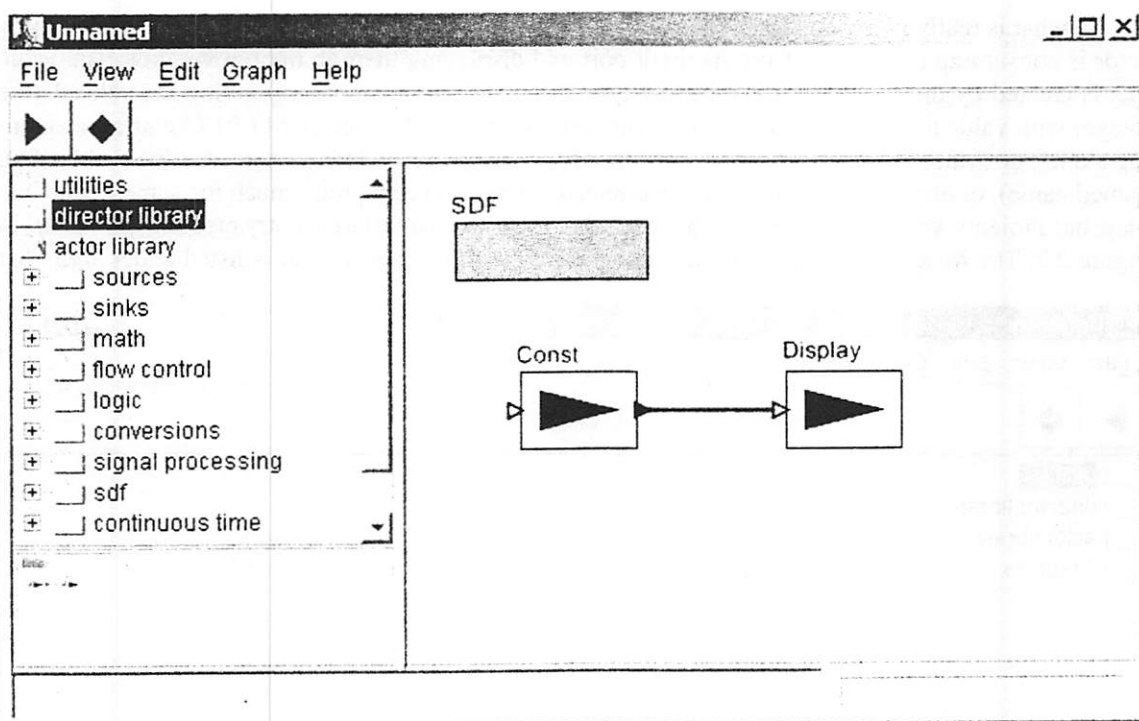

FIGURE 2.4. The Hello World example.

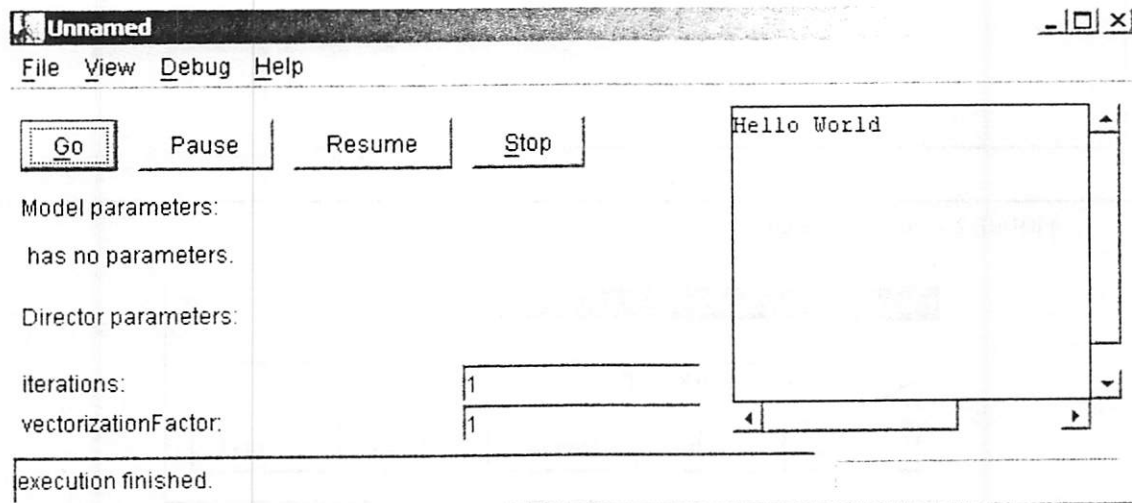

FIGURE 2.6. Execution of the Hello World example.

Change the value of the Const actor back to “Hello World”. When you execute the model, you should see an error window popup. Not to worry, this window is just telling you that you have tried to subtract a string value from an integer value, which doesn’t make much sense at all.

Let’s try a small change to the model to get something that is executable. Disconnect the *Const* from the lower port of the *AddSubtract* actor and connect it instead to the upper port. You can do this by selecting the connection and deleting it (using the delete key), then adding a new connection or by selecting it and dragging one of its endpoints to the new location¹. Notice that the upper port is hollow; this indicates that it is a *multiport*, meaning that you can make more than one connection to it. Now when you run the model you should see strings like “0HelloWorld”.

There are actually two things going on here. The first is that all the connections to the same port must have the same type. Ptolemy automatically converts the integers from the *Ramp* to strings. The second is that the strings are added together as strings usually are in Java, which means concatenating them.

2.4 Hierarchy

Let’s look at a slightly more interesting problem. In this case, a small signal processing problem, where we are interested in recovering a signal based only on noisy measurements of it. First open a new document and drag in a *Typed Composite Actor* from the *utilities* library. This actor is going to add the noise to our measurements. First, using the context menu (right click over the composite actor), select “Rename” and give the composite a good name, like “Channel”. Then, using the context menu again, select “look inside” on the actor. You should get a blank graph editor. The original graph editor is still open. To see it, move the new one using its title bar.

First we have to add some external ports. There are several ways to do this, but clicking on the port toolbar button is probably the easiest. The port toolbar button is the small black triangle at the upper left. Create two ports and rename them *input* and *output*. Using the context menu on the background,

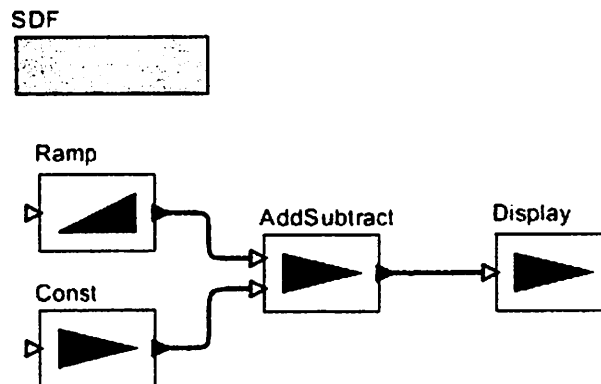

FIGURE 2.7. Another example

1. **Hint:** The connection can sometimes be difficult to select by clicking on it, since you have to precisely on it. To select it more easily, drag out a small box that overlaps it.

select *Configure ports* and set *input* to be an input port and *output* to be an output port. Then using these ports, create the diagram shown in Figure 2.8¹.

The *Gaussian* actor creates values from a Gaussian distributed random variable, and is found in the *sources* library. Now if you close this editor and return to the previous one, you should be able to easily create the model shown in figure 2.9. The *Sinewave* actor is listed under *signal processing*, and the *SequencePlotter* actor is found in *sinks*. Notice that the *Sinewave* actor is also a hierarchical model, as suggested by its red outline. If you execute this model (you will probably want to set the iterations to something reasonable, like 200), you should see something like Figure 2.10.

2.5 Broadcast Relations

In the previous section we showed only one noisy measurement of the original signal. Now let's try to remove some of the noise. First, make three copies of the channel by selecting the one we created before, copying and pasting. We want to feed the original signal through all four channels and average

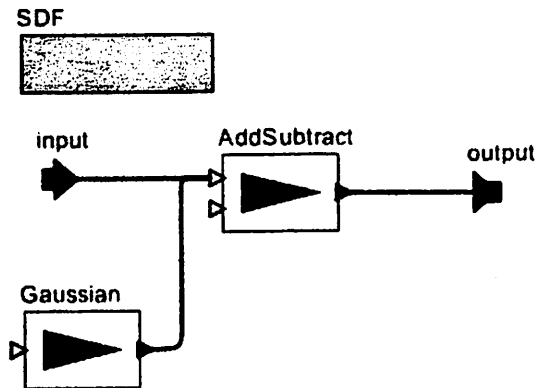

FIGURE 2.8. An example of a hierarchical model.

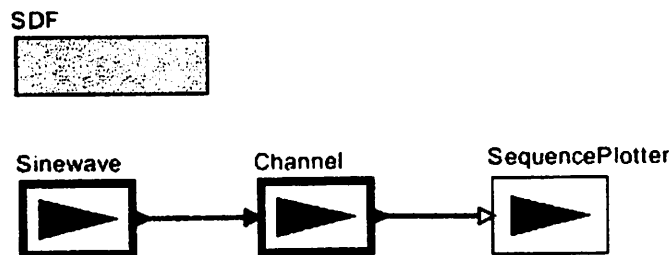

FIGURE 2.9. A simple signal processing example.

1. **Hint:** to create a connection starting on one of the external ports, hold down the control key when dragging.

the outputs of the channel. To broadcast the output of the Sinewave to more than one place, first create a relation (represented by a diamond), and then connect each of the ports to the relation. The relation can be created using the toolbar, or by control-clicking on the background. This should allow you to create the model shown in Figure 2.11. The parameter of the *Const* actor is 4, and the *MultiplyDivide* actor is found in the *math* library.

2.6 SDF and Multirate Systems

So far we have been dealing with relatively simple systems. They are simple in the sense that each actor produces and consumes one token from each port at a time. In this case, the SDF director simply ensures that an actor fires after the actors whose value it depends on. The number of output values that

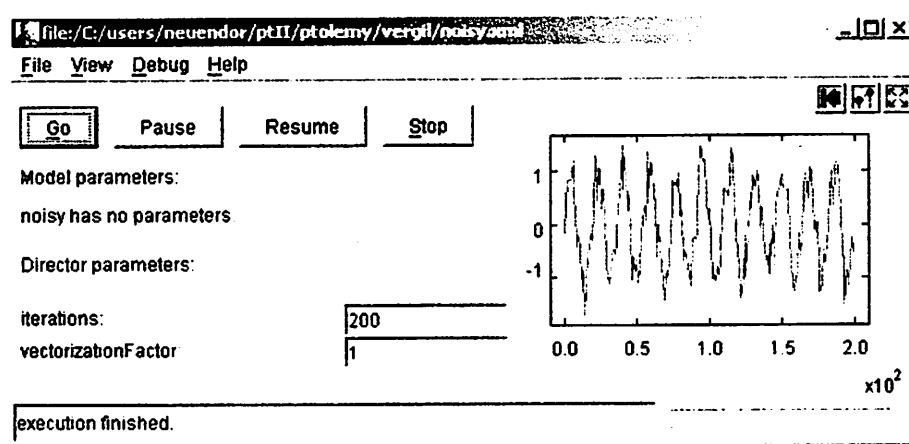

FIGURE 2.10. The output of the simple signal processing example above.

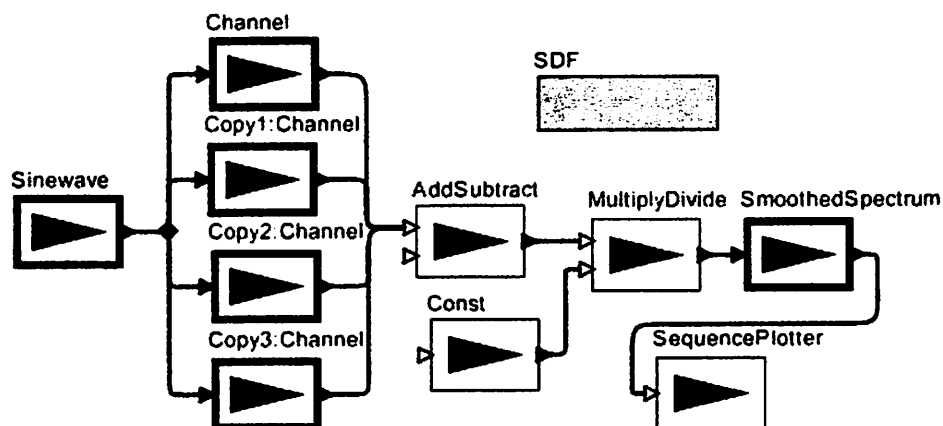

FIGURE 2.11. An example of a broadcast relation.

is created is determined by the number of iterations.

It turns out that the SDF scheduler is actually much more sophisticated. It is capable of scheduling the execution of actors with arbitrary prespecified data rates. Not all actors produce and consume just a single sample each time they are invoked (*fired*). Some require several input samples (*tokens*) before they can be fired, and produce several tokens when they are fired.

One such actor is a spectral estimation actor. Figure 2.12 shows a system that computes the spectrum of a sine wave. The spectrum actor has a single parameter, which gives the *order* of the FFT used to calculate the spectrum. Figure 2.13 shows the output of the model with *order* set to 8 and the number of *iterations* set to 1. **Note that there are 256 output samples.** This is because the Spectrum actor requires 2^8 , or 256 input samples to fire, and produces 2^8 , or 256 output samples when it fires. Thus, one iteration of the model produces 256 samples.

2.7 Using the Plotter

The plot shown in figure 2.13 is not particularly satisfying. It has no title, the axes are not labeled, and the horizontal axis ranges from 0 to 255¹, because in one iteration, the Spectrum actor produces 256 output tokens. These outputs represent frequency bins that range between $-\pi$ and π radians per

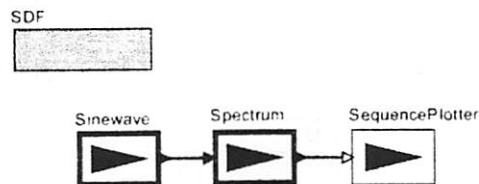

FIGURE 2.12. A multirate SDF model.

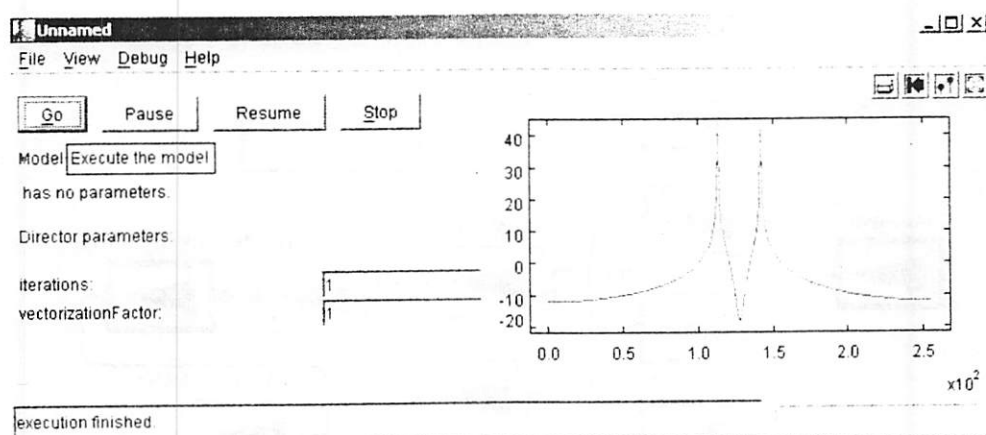

FIGURE 2.13. Execution of the multirate SDF model.

1. **Hint:** Notice the “ $\times 10^2$ ” at the bottom right, which indicates that the label “2.5” stands for “250”.

second.

The SequencePlotter actor has some pertinent parameters, shown in figure 2.14. The *xInit* parameter specifies the value to use on the horizontal axis for the first token. The *xUnit* parameter specifies the value to increment this by for each subsequent token. Setting these to “-PI” and “PI/128” respectively results in the plot shown in figure 2.15.

This plot is better, but still missing useful information. To control more precisely the visual appearance of the plot, click on the second button from the right in the row of buttons at the top right of the plot. This button brings up a format control window. It is shown in figure 2.16, filled in with values that result in the plot shown in figure 2.17. Most of these are self-explanatory, but the following pointers may be useful:

- The grid is turned off to reduce clutter.
- Titles and axis labels have been added.
- The X range and Y range are determined by the fill button at the upper right of the plot.
- Stem plots can be had by clicking on “Stems”
- Individual tokens can be shown by clicking on “dots”
- Connecting lines can be eliminated by deselecting “connect”
- The X axis label has been changed to symbolically indicate multiples of $\pi/2$. This is done by entering the following in the X Ticks field:

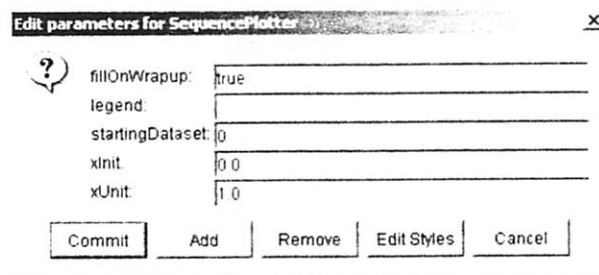

FIGURE 2.14. Parameters of the SequencePlotter actor.

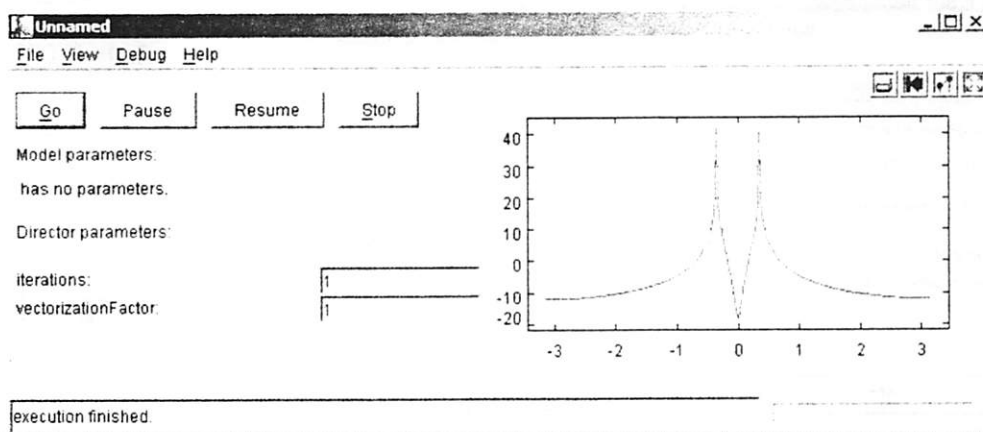

FIGURE 2.15. Better labeled plot, where the horizontal axis now properly represents the frequency values.

-PI -3.14159, -PI/2 -1.570795, 0 0.0, PI/2 1.570795, PI 3.14159

The syntax in general is:

label value, label value, ...

where the label is any string (enclosed in quotation marks if it includes spaces), and the value is a number.

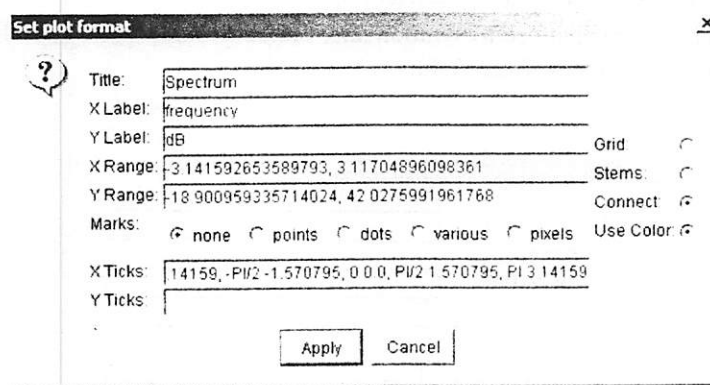

FIGURE 2.16. Format control window for a plot.

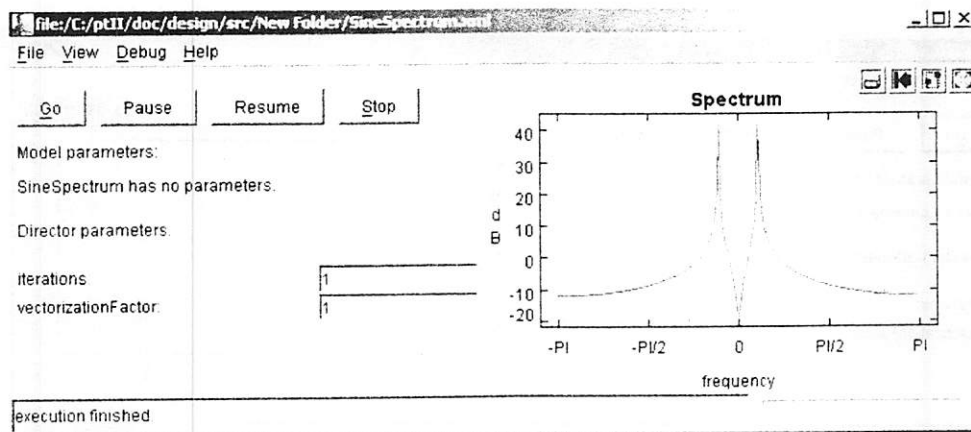

FIGURE 2.17. Still better labeled plot.

3

Actor Libraries

Authors: Chamberlain Fong
Mudit Goel
Christopher Hylandsx
Bart Kienhuis
Edward A. Lee
Michael Leung
Jie Liu
Xiaojun Liu
Steve Neuendorffer
Sarah Packman
Shankar Rao
Michael Shilman
Jeff Tsay
Brian K. Vogel
Paul Whitaker
Yuhong Xiong

3.1 Overview

Ptolemy II is about component-based design. Components are aggregated and interconnected to construct a model. One of the advantages of such an approach to design is that re-use of components becomes possible. In Ptolemy II, re-use potential is maximized through the use of polymorphism. Polymorphism is one of the key tenets of object-oriented design. It refers to the ability of a component to adapt in a controlled way to the type of data being supplied. For example, an addition operation is realized differently for vectors vs. scalars.

We call this classical form of polymorphism *data polymorphism*, because objects are polymorphic with respect to data types. A second form of polymorphism, introduced in Ptolemy II, is *domain polymorphism*, where a component adapts in a controlled way to the protocols that are used to exchange data between components. For example, an addition operation can accept input data delivered by any

of a number of mechanisms, including discrete-events, rendezvous, or asynchronous message passing.

Ptolemy includes libraries of polymorphic actors using both kinds of polymorphism to maximize re-usability. Actors from these libraries can be used in a broad range of domains, where the domain provides the communication protocol between actors. In addition, most of these actors are data polymorphic, meaning that they can operate on a broad range of data types. In general, writing data and domain polymorphic actors is considerably more difficult than writing more specialized actors. This chapter discusses some of the issues.

3.2 Actor Classes

Figure 3.1 shows a UML static structure diagram for the key classes in the `ptolemy.actor.lib` package (see appendix A of chapter 1 for an introduction to UML). All the classes in figure 3.1 extend `TypedAtomicActor`, except `TimedActor` and `SequenceActor`, which are interfaces. `TypedAtomicActor` is in the `ptolemy.actor` package, and is described in more detail in the Actor chapter. For our purposes here, it is sufficient to know that it provides a base class for actors with ports where the ports carry typed data (encapsulated in objects called *tokens*).

None of the classes in figure 3.1 have any methods, except those inherited from the base classes, which are not shown. They do, however, have public members, most of which are instances of `TypeDIOPort`. By convention, actors in Ptolemy II expose their ports and parameters as public members, and much of the functionality of an actor is accessed through the ports and parameters.

Many of the actors are *transformers*, which extend the `Transformer` base class. These actors read input data, modify it in some way, and produce output data. Some other actors that also have this character, such as `AddSubtract`, `MultiplyDivide`, and `Expression`, do not extend `Transformer` because they have somewhat unconventional port names. These actors are represented in the figure by the box labeled “... Other Actors...”.

The stacked boxes labeled “... Transformers ...” and “... Other Actors ...” in figure 3.1 are not standard UML. They are used here to refer to a set of actors that are listed below. There are too many actors to show them individually in the static structure diagram. The diagram would lose its utility because of the resulting clutter.

Most of the library actors can be used in any domain. Some domains, however, can only execute a subset of the actors in this library. For example, the CT domain (continuous time), which solves ordinary differential equations, may present data to actors that represents arbitrarily closely spaced samples of a continuous-time signal. Thus, the data presented to an actor cannot be assumed by the actor to be a sequence, since the domain determines how closely spaced the samples are. For example, the `SampleDelay` actor would produce unpredictable results, since the spacing of samples is likely to be uneven over time.

The `TimedActor` or `SequenceActor` interfaces are intended to declare assumptions that the actor makes about the inputs. They are empty interfaces (no methods), and hence are used only as markers. An actor that implements `SequenceActor` declares that its inputs are assumed to be sequences of distinct data values, and that the outputs it produces will be sequences of distinct data values. In particular, the input must not be a continuous-time waveform. Thus, any actor that will not work properly in the CT (continuous-time) domain should declare that it implements this interface¹. Most actors do not

1. Unfortunately, a scan of the current actor library (as of version 1.0) will reveal that we have not been very rigorous about this, and many actors that make a sequential assumption about the input fail to implement this interface.

implement `SequenceActor`, because they do not care whether the input is a sequence.

Implementing the `TimedActor` interface declares that the current time in a model execution affects the behavior of the actor. Currently, all domains can execute actors that implement `TimedActor`, because all directors provide a notion of current time. However, the results may not be what is expected. The SDF domain (synchronous dataflow), for example, does not advance current time. Thus, if it is the top-level domain, current time will always be zero, which is likely to lead to some confusion with timed actors.

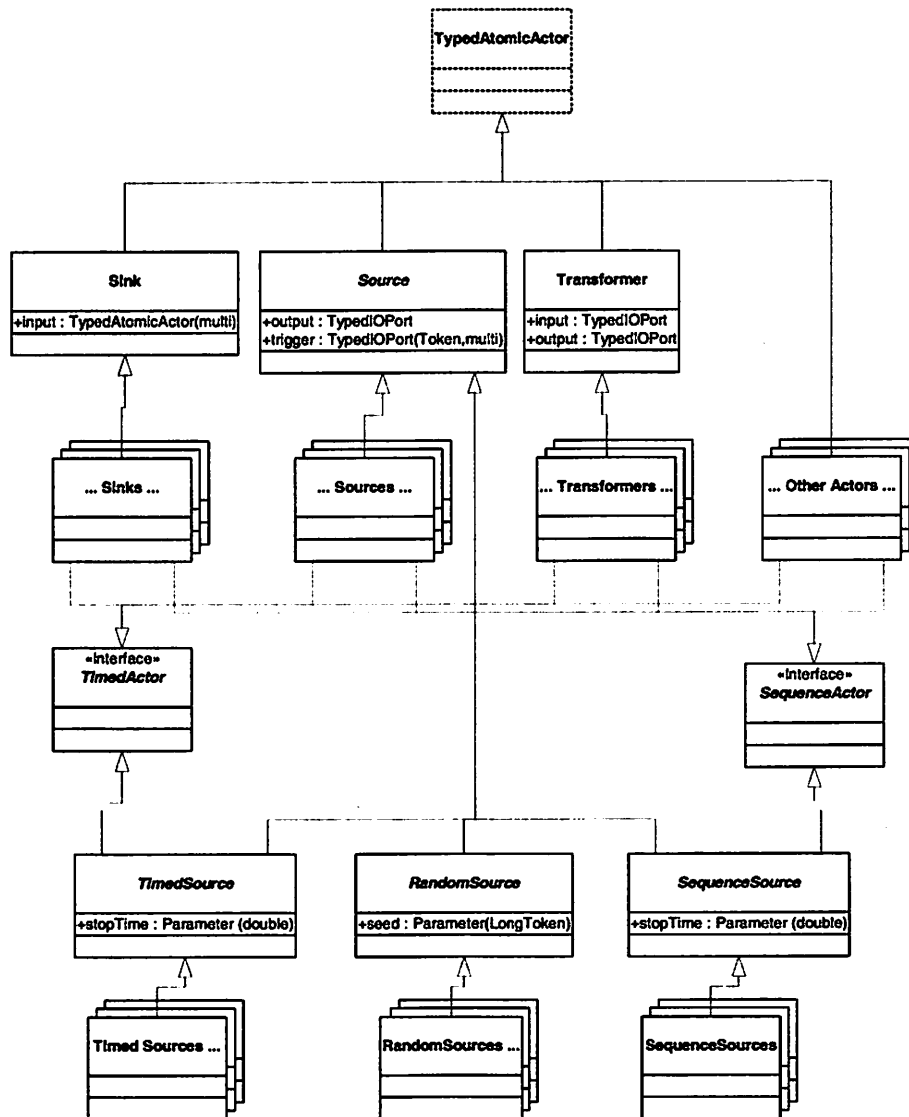

FIGURE 3.1. Key actor base classes and interfaces.

3.3 Actor Summaries

In this section, we summarize the actors that are provided in the default Vergil library, shown at the left in figure 3.2. This library is organized for user convenience, and the organization does not exactly match the package structure. The following section will discuss the package architecture, explaining why actors are defined where they are. This should be viewed as a summary only. Refer to the class documentation for a complete description of these actors (in Vergil, you can right-click on an icon and select “Get Documentation” to get the detailed documentation for an actor). This summary is useful, however, because it gives a high-level view of what’s available. Some general terms that may be useful in interpreting the descriptions are:

lub: Least upper bound, referring particularly to data types. For typical data polymorphic actors, the output data type is the lub of the input data types. This means that each input data type can be losslessly converted to the type of the output. In some cases, the output data type also depends on the type of parameters. See the data package chapter for more detail.

multiport: A port that links to any number of channels. Ports described below are multiports only if they say so explicitly. Multiports can be left disconnected in all domains, in which case no inputs are read. Multiports resolve to a single data type, so all channels must have the same data type.

It is also useful to know some general patterns of behavior.

- Unless otherwise stated, actors will read at most one input token from each input channel of each input port, and will produce at most one output token. No output token is produced unless there are input tokens.

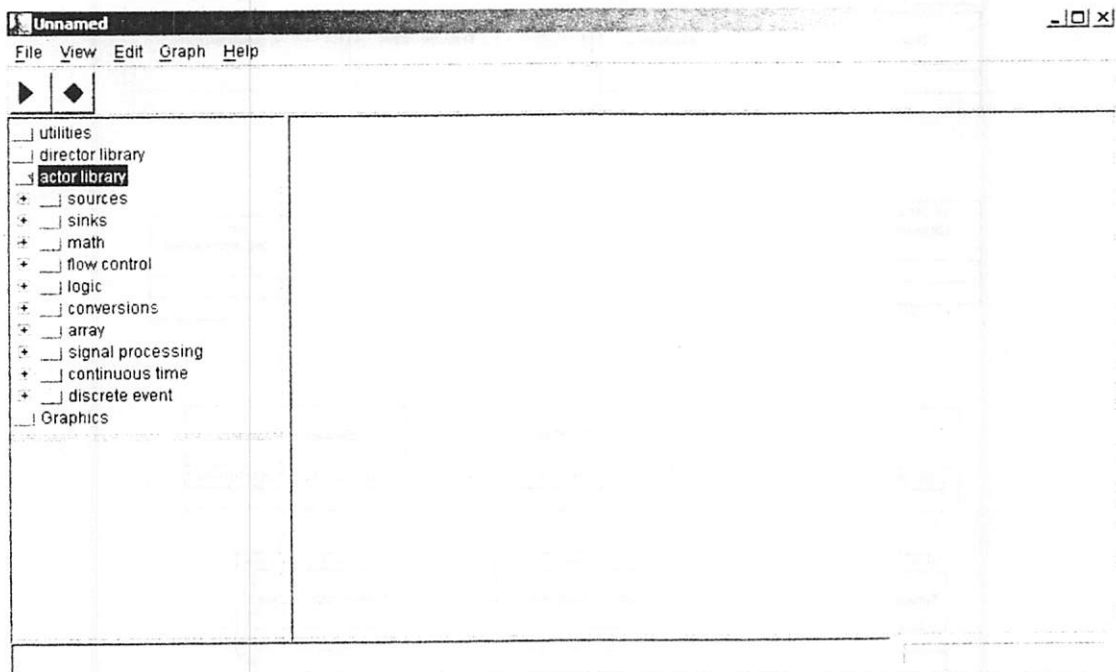

FIGURE 3.2. The default Vergil actor library is shown at the left, expanded to the first level.

- Unless otherwise stated, actors can operate in all domains except FSM, where the components are instances of FSMState. The actors that implement the SequenceActor or TimedActor interfaces may be rejected by some domains.

3.3.1 Sources

A source actor is a source of tokens. Most source actors extend the Source base class, as shown in figure 3.1. Such actors have a *trigger* input, which in some domains serves to stimulate an output. In DE, for example, it causes the current value of the source to be produced at the time stamp of the trigger input. The *trigger* port is a multiport, meaning that multiple channels can be connected to it. It can also be left unconnected in domains that will invoke the actor anyway (SDF, CT, DT, PN, ...). There is no need for a trigger in these domains.

Some source actors use the `fireAt()` method of the director to request firing at particular times in the future. In domains that do not ignore `fireAt()`, such as DE, such actors will fire repeatedly even if there is no trigger input. The `fireAt()` method schedules an event in the future to refire the actor.

Those sources that implement TimedActor have a parameter *stopTime*. When the current time of the model reaches this time, then the actor requests of the director that this actor not be invoked again. This can be used to generate a finite source signal. By default, this parameter has value 0.0, which indicates unbounded execution.

Those sources that implement SequenceActor have a parameter *firingCountLimit*. When the number of iterations of the actor reaches this limit, then again the actor requests of the director that this actor not be invoked again. This again can be used to generate a finite source signal. By default, this parameter has value 0, which indicates unbounded execution.

In the summary below, we show the names of ports and parameters in italics, and their type in parentheses. The type indicator “general” means that the port accepts any token. If the port is marked “multiport” then it can be linked to multiple channels. Some of the most useful actors are *Clock*, which is used extensively in DE models to trigger regularly timed events, *Ramp*, which produces a counting sequence, *Const*, which produces a constant, and *Pulse*, which produces an arbitrary sequence.

Bernoulli

Ports: *trigger* (input multiport, general), *output* (boolean).

Parameters: *trueProbability* (double), *seed* (long).

Produce a random sequence of booleans (a source of coin flips).

Clock (implements TimedActor)

Ports: *trigger* (input multiport, general), *output* (type of elements of *values*).

Parameters: *offsets* (array of doubles), *period* (double), *values* (array), *stopTime* (double).

Produce a piecewise-constant, periodic signal (or at minimum, a sequence of events corresponding to transitions in this signal). This actor uses `fireAt()` to schedule firings when time matches the transition times.

Const

Ports: *trigger* (input multiport, general), *output* (type of *value*).

Parameters: *value* (general).

Produce a constant output with value given by *value*.

CurrentTime (implements *TimedActor*)

Ports: *trigger* (input multiport, general), *output* (double).

Parameters: *stopTime* (double).

Produce an output token with value equal to the current time (the model time when the actor is fired).

DiscreteRandomSource

Ports: *trigger* (input multiport, general), *output* (double).

Parameters: *pmf* (array of doubles), *values* (array), *seed* (long).

Produce tokens with the given probability mass function.

Gaussian

Ports: *trigger* (input multiport, general), *output* (double).

Parameters: *mean* (double), *standardDeviation* (double), *seed* (long).

Produce a random sequence where each output is the outcome of a Gaussian random variable.

Interpolator (implements *SequenceSource*)

Ports: *trigger* (input multiport, general), *output* (type of elements of *values*).

Parameters: *indexes* (array of ints), *order* (int), *period* (int), *values* (array of doubles), *firingCountLimit* (int).

Produce an output sequence by interpolating a specified set of values. This can be used to generate complex, smooth waveforms.

PoissonClock

Ports: *trigger* (input multiport, general), *output* (type of elements of *values*).

Parameters: *meanTime* (double), *values* (array), *stopTime* (double).

Produce a piecewise-constant signal where transitions occur according to a Poisson process (or at minimum, a sequence of events corresponding to transitions in this signal). This actor uses `fireAt()` to schedule firings at time intervals determined by independent and identically distributed exponential random variables with mean *meanTime*.

Pulse (implements *SequenceSource*)

Ports: *trigger* (input multiport, general), *output* (type of elements of *values*).

Parameters: *indexes* (array of ints), *values* (array), *firingCountLimit* (int), *repeat* (boolean).

Produce a sequence of values at specified iteration indexes. The sequence repeats itself when the *repeat* parameter is set to true.

Ramp (implements *SequenceSource*)

Ports: *trigger* (input multiport, general), *output* (lub(*init*, *step*)).

Parameters: *init* (general), *step* (general), *firingCountLimit* (int).

Produce a sequence that begins with the value given by *init* and is incremented by *step* after each iteration. The types of *init* and *step* are required to support addition.

SequentialClock

Ports: *output* (type of elements of *values*).

Parameters: *offsets* (array of doubles), *period* (double), *values* (array).

Output a sequence of values at the times given by the *offsets* parameter.

Sinewave

Ports: *output* (double).

Parameters: *samplingFrequency* (double), *frequency* (double), *phase* (double).

Output a sinusoidal waveform.

SketchedSource

Ports: *trigger* (input multiport, general), *output* (double).

Parameters: *dataset* (int), *length* (int), *period* (int).

Output a signal that has been sketched by the user on the screen.

Uniform

Ports: *trigger* (input multiport, general), *output* (double).

Parameters: *lowerBound* (double), *upperBound* (double), *seed* (long).

Produce a random sequence with a uniform distribution.

VariableClock (implements *TimedActor*)

Ports: *trigger* (input multiport, general), *output* (type of elements of *values*), *periodControl*(input, double).

Parameters: *offsets* (array of doubles), *period* (double), *values* (array), *stopTime* (double).

An extension of *Clock* with an input to dynamically control the period.

3.3.2 Sinks

Sinks actors are the ultimate destinations for tokens. They have no outputs, and include actors that display data in plots, textual form, or tables.

Many of these actors are shown in figure 3.3, which shows a UML static structure diagram. Several of these have both time-based and sequence-based versions. The *TimedPlotter*, for example, displays a plot of its input data as a function of time. *SequencePlotter*, by contrast, ignores current time, and uses for the horizontal axis the position of an input token in a sequence of inputs. *XYPlotter*, by contrast, uses neither time nor the sequence number, and therefore implements neither *TimedActor* nor *SequenceActor*. All three are derived from *Plotter*, an abstract base class with a public member, *plot*, which implements the plot. This base class has a *fillOnWrapup* parameter, which has a boolean value. If the value is true (the default), then at the conclusion of the execution of the model, the axes of the plot will be adjusted to just fit the observed data.

These actors all implement the *Placeable* interface. Actors that implement this interface have graphical widgets that a user of the actor may wish to place on the screen. *Vergil* constructs a display panel by placing such actors. More customized placement can be achieved by calling the *setPanel()* method in the *Placeable* interface in custom Java code.

BarGraph

Ports: *input* (multiport, array of doubles).

Parameters: *fillOnWrapup* (boolean), *legend*(string), *startingDataset* (int), *iterationsPerUpdate* (int).

Plot bar graphs, given arrays of doubles as inputs.

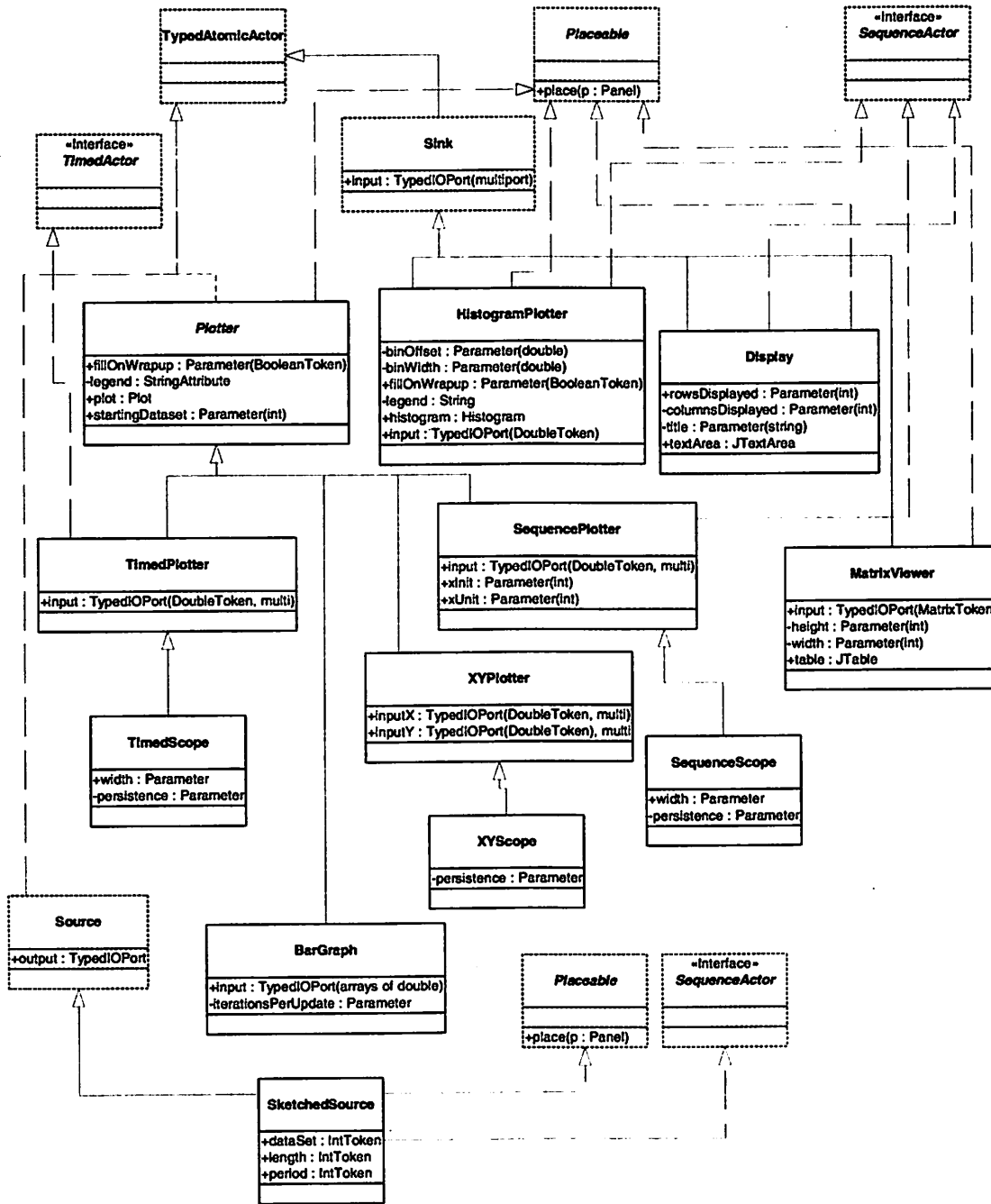

FIGURE 3.3. Organization of actors in the ptolemy.actor.lib.gui package.

Discard

Ports: *input* (multiport, general).
Consume and discard input tokens.

Display

Ports: *input* (multiport, general).
Parameters: *rowsDisplayed* (int), *columnsDisplayed*(int), *title* (string).
Display input tokens in a text area on the screen.

HistogramPlotter

Ports: *input* (multiport, double).
Parameters: *binOffset* (double), *binWidth* (double), *fillOnWrapup* (boolean), *legend* (string).
Display a histogram of the data on each input channel.

MatrixViewer

Ports: *input* (matrix).
Parameters: *height* (int), *width* (int).
Display the entries of a matrix in a table.

Recorder

Ports: *input* (multiport, general).
Parameters: *capacity* (int).
Record the inputs for later querying.

SequencePlotter

Ports: *input* (multiport, double).
Parameters: *fillOnWrapup* (boolean), *legend* (string), *startingDataset* (int), *xInit* (double),
xUnit (double).
Plot the input tokens vs. their index number.

SequenceScope

Ports: *input* (multiport, double).
Parameters: *fillOnWrapup* (boolean), *legend* (string), *persistence* (int), *startingDataset* (int),
width (int), *xInit* (double), *xUnit* (double).
Plot sequences that are potentially infinitely long in an oscilloscope style.

Test

Ports: *input* (multiport, double).
Parameters: *correctValues* (array), *tolerance* (double).
Check the input streams against a parameter value, and throw an exception if they do not match.

TimedPlotter

Ports: *input* (multiport, double).
Parameters: *fillOnWrapup* (boolean), *legend* (string), *startingDataset* (int).
Plot inputs as a function of time.

TimedScope

Ports: *input* (multiport, double).

Parameters: *fillOnWrapup* (boolean), *legend* (string), *persistence* (int), *startingDataset* (int), *width* (int).

Plot inputs as a function of time in oscilloscope style.

XYPlotter

Ports: *inputX* (multiport, double), *inputY* (multiport, double).

Parameters: *fillOnWrapup* (boolean), *legend* (string), *startingDataset* (int).

Display a plot of the data on each *inputX* channel vs. the data on the corresponding *inputY* channel.

XYScope

Ports: *inputX* (multiport, double), *inputY* (multiport, double).

Parameters: *fillOnWrapup* (boolean), *legend* (string), *persistence* (int), *startingDataset* (int).

Display a plot of the data on each *inputX* channel vs. the data on the corresponding *inputY* channel with finite persistence.

3.3.3 Math

The math library (see figure 3.2) consists mostly of transformer actors, each of which calculates some mathematical function. Some of these actors operate on type “scalar”, meaning all numerical data types (complex, double, int, long, and fix)¹.

AbsoluteValue

Ports: *input* (scalar), *output* (scalar).

Produce an output on each firing with a value that is equal to the absolute value of the input.

AddSubtract

Ports: *plus* (multiport, general), *minus* (multiport, general), *output* (lub(*plus*, *minus*)).

Add tokens on the *plus* input channels and subtract tokens on the *minus* input channels.

Average

Ports: *input* (general), *reset* (boolean), *output* (type of *input*).

Parameters: *function* (string).

Output the average of the inputs since the last time a true token was received at the *reset* port. The *reset* input may be left disconnected in most domains.

DotProduct

Ports: *input1* (array), *input2* (array), *output* (array).

Output the dot product of two input arrays.

1. In future releases, these actors may operate also on arrays and matrices.

Expression

Ports: *output* (general).

Parameters: *expression* (string).

On each firing, evaluate the *expression* parameter, whose value is set by an expression that may include references to any input ports that have been added to the actor. The expression language is described in section 9.5 below, with the addition that the expressions can refer to the values of inputs, and to the current time by the variable name “time,” and to the current iteration count by the variable named “iteration.” To add input ports to the actor in Vergil, right click on its icon and select “Configure Ports,” and then select “Add.”

MathFunction

Ports: *firstOperand* (double), *output* (double).

Parameters: *function* (string).

Produce an output token with a value that is a function of the input(s). The function is specified by the *function* attribute, where valid functions are *exp*, *log*, *modulo*, *sign*, *square*, and *sqrt*.

Maximum

Ports: *input* (multiport, scalar), *maximumValue* (multiport, scalar),
channelNumber (multiport, int).

Produce an output token on each firing on *maximumValue* with a value that is the maximum of the values on the input channels. The index of this maximum is output on *channelNumber*.

Minimum

Ports: *input* (multiport, scalar), *minimumValue* (multiport, scalar), *channelNumber* (multiport, int).

Produce an output token on each firing on *minimumValue* with a value that is the minimum of the values on the input channels. The index of this minimum is output on *channelNumber*.

MultiplyDivide

Ports: *multiply* (multiport, general), *divide* (multiport, general), *output* (lub(*multiply*, *divide*)).

Multiply tokens on the *multiply* input, and divide by tokens on the *divide* input.

Quantizer

Ports: *input* (double), *output* (double).

Parameters: *levels* (array of doubles).

Produce an output token with the value in *levels* that is closest to the input value.

Remainder

Ports: *input* (double), *output* (double).

Parameters: *divisor* (double).

Produce an output token with the value that is the remainder after dividing the token on the *input* port by the *divisor*.

Scale

Ports: *input* (general), *output* (lub(*input*, *factor*)).

Parameters: *factor* (general).

Produce an output that is the product of the *input* and the *factor*.

TrigFunction

Ports: *input* (double), *output* (double).
Parameters: *function* (string).

Produce an output token with a value that is a function of the input. The function is specified by the *function* attribute, where valid functions are *acos*, *asin*, *atan*, *cos*, *sin*, and *tan*.

3.3.4 Flow Control

The flow control actor affect the routing of token of a topology.

Chop (implements SequenceActor)

Ports: *input* (multiport, general), *output* (type of *input*).
Parameters: *numberToRead* (int), *numberToWrite* (int), *offset* (int), *usePastInputs* (boolean).

Chop an input sequence and construct from it a new output sequence. This actor can be used, for example, for zero-padding, overlapping windows, delay lines, etc..

Commutator (implements SequenceActor)

Ports: *input* (multiport, general), *output* (type of *input*).

Interleave the data on the input channels into a single sequence on the output.

Distributor (implements SequenceActor)

Ports: *input* (general), *output* (multiport, type of *input*).

Distribute the data on the input sequence into multiple sequences on the output channels.

Multiplexor

Ports: *input* (multiport, general), *select* (int), *output* (type of *input*).

Produce as output the token on the channel of *input* specified by the *select* input (one token is read from each channel of *input* in each firing).

RecordAssembler

Ports: *output* (record).

Produce an output token that results from combining a token from each of the input ports (which must be added by the user). To add input ports to the actor in Vergil, right click on its icon and select "Configure Ports," and then select "Add." The name of each field in the record is the name of the port that supplies the field.

RecordDisassembler

Ports: *input* (record).

Produce output tokens on the output ports (which must be added by the user) that result from separating the record on the input port. To add output ports to the actor in Vergil, right click on its icon and select "Configure Ports," and then select "Add." The name of each field extracted from the record is the name of the output port to which the value of the field is sent.

RecordUpdater

Ports: *input* (record), *output* (record).

Produce an output token that results from replacing fields in the record read from the *input* port with values supplied by other ports. The user must create other input ports to use this. The names of those ports determine which field is replaced.

Repeat

Ports: *input* (multiport, general), *output* (type of *input*).

Parameters: *numberOfTimes* (int), *blockSize*(int).

Repeat on the *output* a block of tokens read from the *input* the specified number of times.

SampleDelay

Ports: *input* (multiport, general), *output* (type of *input*).

Parameters: *initialOutputs* (array).

Produce on the *output* the tokens read from the *input*, delayed by some number of firings. The amount of delay is the length of the *initialOutputs* array. That array also provides the initial outputs for the first few firings.

Select

Ports: *input* (multiport, general), *control* (int), *output* (type of *input*).

Produce as output the token on the channel of *input* specified by the *control* input (only this token is read).

Sequencer (implements *SequenceActor*)

Ports: *input* (general), *sequenceNumber* (int), *output* (type of *input*).

Parameters: *startingSequenceNumber* (int).

Put tokens in order according to their numbers in a sequence.

Sleep

Ports: *input* (multiport, general), *output* (multiport, general).

Parameters: *delay* (long).

Produce as output the tokens received on *input* after a time delay specified by *delay*.

Switch

Ports: *input* (general), *control* (int), *output* (multiport, type of *input*).

Produce the token read from the *input* port on the channel of *output* specified by the *control* input.

Synchronizer

Ports: *input* (multiport, general), *output* (multiport, type of *input*).

Wait until at least one token exists on each channel of *input*, and then produce these tokens on the corresponding channels of *output*.

3.3.5 Logic

Comparator

Ports: *left* (double), *right* (double), *output* (boolean).

Parameters: *comparison* (string), *tolerance* (double).

Produce an output token with a value that is a comparison of the input. The comparison is specified by the *comparison* attribute, where valid comparisons are $>$, $>=$, $<$, $<=$, and $==$.

Equals

Ports: *input* (multiport, general), *output* (boolean).

Consume one token from each channel of *input*, and produce an output token with value *true* if these tokens are equal in value, and false otherwise.

LogicalNot

Ports: *input* (boolean), *output* (boolean).

Produce an output token which is the logical negation of the input token.

LogicFunction

Ports: *input* (multiport, boolean), *output* (boolean).

Parameters: *function* (string).

Produce an output token with a value that is a logical function of the tokens on the channels of *input*. The function is specified by the *function* attribute, where valid functions are *and*, *or*, *xor*, *nand*, *nor*, and *xnor*.

3.3.6 Conversions

Ptolemy II has a sophisticated type system that allows actors to be polymorphic (to operate on multiple data types). Typically, actors express type constraints between their ports and their parameters. When actors are connected, these type constraints are resolved to determine the type of each port. Conversions between types are automatic if they result in no loss of data. However, sometimes, a model builder may wish to force a particular conversion. The actors in the conversions library support this.

BitsToInt

Ports: *input* (boolean), *output* (int).

Convert 32 successive binary inputs into a two's complement integer.

CartesianToComplex

Ports: *real* (double), *imag* (double), *output* (complex).

Convert two tokens representing the real and imaginary of a complex number into their complex representation.

CartesianToPolar

Ports: *x* (double), *y* (double), *angle* (double), *magnitude* (double).

Convert a Cartesian pair (a token on *x* and a token on *y*) to two tokens representing its polar form (which are output on *angle* and *magnitude*).

ComplexToCartesian

Ports: *input* (complex), *real* (double), *imag* (double).

Convert a token representing a complex number into its Cartesian components (which are output on *real* and *imag*).

ComplexToPolar

Ports: *input* (complex), *angle* (double), *magnitude* (double).

Convert a token representing a complex number into two tokens representing its polar form (which are output on *angle* and *magnitude*).

DoubleToFix

Ports: *input* (double), *output* (fix).

Parameters: *precision* (matrix of ints), *quantization* (string).

Convert a double into a fix point number with a specific precision, using a specific quantization strategy.

FixToDouble

Ports: *input* (fix), *output* (double).

Parameters: *precision* (matrix of ints), *quantization* (string).

Convert a fix point into a double, by first setting the precision of the fix point to the supplied precision, using a specific quantization strategy.

FixToFix

Ports: *input* (fix), *output* (fix).

Parameters: *overflow* (string), *precision* (matrix of ints), *quantization* (string).

Convert a fix point into another fix point with possibly a different precision, using a specific quantizer and overflow strategy.

IntToBits

Ports: *input* (int), *output* (boolean).

Convert an input integer into 32 successive binary outputs.

PolarToCartesian

Ports: *angle* (double), *magnitude* (double), *x* (double), *y* (double).

Converts two tokens representing a polar coordinate (a token on *angle* and a token on *magnitude*) to two tokens representing their Cartesian form (which are output on *x* and *y*).

PolarToComplex

Ports: *angle* (double), *magnitude* (double), *output* (complex).

Converts two tokens representing polar coordinates (a token on *angle* and a token on *magnitude*) to a token representing their complex form.

Round

Ports: *input* (double), *output* (int).

Parameters: *function* (string).

Produce an output token with a value that is a rounded version of the input. The rounding method is specified by the *function* attribute, where valid functions are *ceil*, *floor*, *round*, and *truncate*.

3.3.7 Array

The array library supports manipulations of arrays, which are ordered collections of tokens of arbitrary type.

ArrayAppend

Ports: *input* (multiport, array), *output* (array).

Append arrays on the input channels to produce a single output array.

ArrayElement

Ports: *input* (array), *output* (array).

Parameters: *index* (int).

Extract an element from an array and produce it on the output port.

ArrayExtract

Ports: *input* (array), *output* (array).

Parameters: *sourcePosition* (int), *extractLength* (int), *destinationPosition* (int), *outputArrayLength* (int).

Extract a subarray from an array and produce it on the output port.

ArrayLength

Ports: *input* (array), *output* (int).

Output the length of the input array.

ArrayToSequence

Ports: *input* (array), *output* (type of *input* element).

Parameters: *arrayLength* (int), *enforceArrayLength* (boolean).

Extract all elements from an *input* array and produce them sequentially on the output port.

SequenceToArray

Ports: *input* (general), *output* (array).

Parameters: *arrayLength* (int).

Collect a sequence of inputs into an array and produce the array on the output port.

3.3.8 Signal Processing

The signal processing library is divided into sublibraries.

Audio

The audio library provides actors that can read and write audio files, can capture data from an audio input such as a CD or microphone, and can play audio data through the speakers of the computers. It uses the `javasound` library, which is part of the 1.3 distribution of Java Platform 2 from Sun Microsystems. The `AudioCapture` and `AudioPlayer` actors are unusual in that they have coupled parameter values. Changing the parameters of one results in the parameters of the other being changed. Also, as of this writing, they have the restriction that only one of each may be used in a model at a time, and that if there are two models that use them, then those two models may not be executed simultaneously.

AudioCapture

Ports: *trigger* (multiport, general), *output* (multiport, double).

Parameters: *sampleRate* (int), *bitsPerSample* (int), *channels* (int).

Capture audio from the audio input port of the computer, or from its microphone, and produce the samples at the output.

AudioReader

Ports: *trigger* (multiport, general), *output* (multiport, double).

Parameters: *sourceURL* (string).

Read audio from a URL, and produce the samples at the output.

AudioPlayer

Ports: *input* (multiport, double).

Parameters: *sampleRate* (int), *bitsPerSample* (int), *channels* (int).

Play audio samples on the audio output port of the computer, or from its speakers.

AudioWriter

Ports: *input* (multiport, double).

Parameters: *pathName* (string), *sampleRate* (int), *bitsPerSample* (int), *channels* (int).

Write audio data to a file.

Communications

The communications library, which has barely been started, will eventually collect actors that support modeling and design of digital communication systems. Currently, it contains only three actors.

LineCoder

Ports: *input* (boolean), *output* (type of element of *table*)

Parameters: *table* (array), *wordLength* (int).

Read a sequence of booleans (of length *wordLength*) and interpret them as a binary index into the *table*, from which a token is extracted and sent to the output.

LMSAdaptive

Ports: *input* (double), *error* (input, double), *output* (double), *tapValues* (output, array of doubles).

Parameters: *decimation* (int), *decimationPhase* (int), *stepSize*(double), *errorDelay*(int), *initialTaps*(array of doubles).

Filter the input with an adaptive filter, and update the coefficients of the filter using the input error signal according to the LMS (least mean-square) algorithm.

RaisedCosine

Ports: *input* (double), *output* (double)

Parameters: *decimation* (int), *decimationPhase* (int), *interpolation* (int), *length*(int), *excessBW*(double), *root* (boolean), *symbolInterval* (int).

An FIR filter with a raised cosine frequency response. This is typically used in a communication systems as a pulse shaper or a matched filter.

Filtering

DelayLine

Ports: *input* (general), *output* (array).

Parameters: *initialValues* (array).

In each firing, output the n most recent input tokens collected into an array, where n is the length of *initialValues*. In the beginning, before there are n most recent tokens, use the tokens from *initialValues*.

DownSample

Ports: *input* (general), *output* (type of *input*).

Parameters: *factor* (int), *phase* (int).

Read *factor* inputs and produce only one of them on the output.

FIR

Ports: *input* (general), *output* (general).

Parameters: *decimation* (int), *decimationPhase* (int), *interpolation* (int), *taps* (array).

Produce an output token with a value that is the input filtered by an FIR filter with coefficients given by *taps*.

IIR

Ports: *input* (double), *output* (double).

Parameters: *numerator* (array of doubles), *denominator* (array of doubles).

Produce an output token with a value that is the input filtered by an IIR filter using a direct form II implementation.

Lattice

Ports: *input* (double), *output* (double).

Parameters: *reflectionCoefficients* (array).

Produce an output token with a value that is the input filtered by an FIR lattice filter with coefficients given by *reflectionCoefficients*.

LMSAdaptive

Ports: *input* (double), *error* (input, double), *output* (double), *tapValues* (output, array of doubles).

Parameters: *decimation* (int), *decimationPhase* (int), *stepSize*(double), *errorDelay*(int), *initialTaps*(array of doubles).

Filter the input with an adaptive filter, and update the coefficients of the filter using the input error signal according to the LMS (least mean-square) algorithm.

RecursiveLattice

Ports: *input* (double), *output* (double).

Parameters: *reflectionCoefficients* (array).

Produce an output token with a value that is the input filtered by a recursive lattice filter with coefficients given by *reflectionCoefficients*.

UpSample

Ports: *input* (general), *output* (type of *input*).

Parameters: *factor* (int), *phase* (int).

Read one input token and produce *factor* outputs, with all but one of the outputs being a zero of the same type as the input.

VariableFIR

Ports: *input* (general), *newTaps* (input, array), *output* (general).

Parameters: *decimation* (int), *decimationPhase* (int), *interpolation* (int), *blockSize* (int).

Filter the input sequence with an FIR filter with coefficients given on the *newTaps* input port. The *blockSize* parameter specifies the number of successive inputs that are processed for each set of taps provided on *newTaps*.

VariableLattice

Ports: *input* (double), *newTaps* (input, array of doubles), *output* (double).

Parameters: *blockSize* (int).

Filter the input sequence with an FIR lattice filter with coefficients given on the *newCoefficients* input port. The *blockSize* parameter specifies the number of successive inputs that are processed for each set of taps provided on *newCoefficients*.

VariableRecursiveLattice

Ports: *input* (double), *newTaps* (input, array of doubles), *output* (double).

Parameters: *blockSize* (int).

Filter the input sequence with a recursive lattice filter with coefficients given on the *newCoefficients* input port. The *blockSize* parameter specifies the number of successive inputs that are processed for each set of taps provided on *newCoefficients*.

Image Processing

A preliminary image processing library is provided with the 1.0 release, but it is at a sufficiently early stage of development that we do not document here. See the on-line documentation.

Spectrum

DB

Ports: *input* (double), *output* (double).

Parameters: *inputIsPower* (boolean), *min* (double).

Produce a token that is the value in decibels ($k \cdot \log_{10}(z)$) of the token received, where k is 10 if *inputIsPower* is true, and 20 otherwise. The output is never less than *min* (it is clipped if necessary).

FFT

Ports: *input* (complex), *output* (complex).

Parameters: *order* (int).

A fast Fourier transform of size 2^{order} .

IFFT

Ports: *input* (complex), *output* (complex).
Parameters: *order* (int).

An inverse fast Fourier transform of size 2^{order} .

LevinsonDurbin

Ports: *autocorrelation* (input, array of doubles), *errorPower* (output, array of doubles),
linearPredictor (output, array of doubles), *reflectionCoefficients* (output, array of doubles).

Calculate the linear predictor coefficients (for both an FIR and Lattice filter) for the specified autocorrelation input.

MaximumEntropySpectrum

Ports: *input* (double), *output* (double).
Parameters: *order* (int), *numberOfInputs* (int), *log2resolution*(int).

A fancy spectrum estimator that uses the LevinsonDurbin algorithm to calculate linear predictor coefficients, and then uses those as a parametric model for the random process.

SmoothedSpectrum

Ports: *input* (double), *output* (double).
Parameters: *order* (int), *numberOfInputs* (int), *log2resolution*(int).

A spectrum estimator called the Blackman-Tukey algorithm, which estimates an autocorrelation function by averaging products of the input samples, and then calculates the FFT of that estimate.

Spectrum

Ports: *input* (double), *output* (double).
Parameters: *order* (int), *numberOfInputs* (int), *log2resolution*(int).

A simple spectrum estimator that calculates the FFT of the input. For a random process, this is called the periodogram spectral estimate.

PhaseUnwrap

Ports: *input* (double), *output* (double).

A simple phase unwrapper.

Statistical

A small number of statical actors are provided.

Autocorrelation

Ports: *input* (general), *output* (array of type of *input*).
Parameters: *numberOfInputs* (int), *numberOfLags* (int), *biased*(boolean),
symmetricOutput (boolean).

Estimate the autocorrelation by averaging products of the input samples.

PowerEstimate

Ports: *input* (double), *output* (double).
Parameters: *forgettingFactor* (double).

Estimate the power of the input signal.

3.3.9 Continuous Time

The continuous-time library contains a set of actors designed specifically for use in the CT domain.

Integrator

Ports: *input* (double), *output* (double).

Parameters: *initialState* (double).

Integrate the input signal over time to produce the output signal. That is, the input is the derivative of the output with respect to time. This actor can be used to close feedback loops in CT to define interesting differential equation systems.

ContinuousTransferFunction

Ports: *input* (double), *output* (double).

Parameters: *denominator* (array of doubles), *numerator* (array of doubles), *C*

Filter the input with the specified rational Laplace transform transfer function. Note that this actor constructs a submodel, so it might be interesting to look inside the actor after it is initialized.

LinearStateSpace

Ports: *input* (multiport, double), *output* (multiport, double).

Parameters: *A* (double matrix), *B* (double matrix), *C* (double matrix), *D* (double matrix), *initialStates* (double row matrix).

Filter the input with a linear system. Note that this actor constructs a submodel, so it might be interesting to look inside the actor after it is initialized.

DifferentialSystem

Parameters: *stateVariableNames* (array of strings), *initialStates* (array of doubles), *C*

Filter the input with the specified system, which can nonlinear, and is specified using the expression language. Note that this actor constructs a submodel, so it might be interesting to look inside the actor after it is initialized.

CTPeriodicSampler

Ports: *input* (multiport, double), *output* (multiport, double).

Parameters: *samplePeriod* (double).

Sample the input signal with the specified rate, producing discrete output events.

CTTriggeredSampler

Ports: *input* (multiport, double), *trigger* (input, general), *output* (multiport, double).

Sample the input signal at times where the trigger input has a discrete input events.

RateLimiter

Ports: *input* (double), *output* (double).

Parameters: *risingSlewRate* (double), *fallingSlewRate* (double).

Limit the first derivative of the input signal, and produce the result as an output sequence.

ThresholdMonitor

Ports: *input* (double), *output* (double).

Parameters: *thresholdWidth* (double), *thresholdCenter* (double).

Output *true* if the input value is in the interval $[a, b]$, which is centered at *thresholdCenter* and has width *thresholdWidth*. This actor controls the the integration step size so that the input does not cross the threshold without producing at least one *true* output.

ZeroCrossingDetector

Ports: *input* (double), *trigger* (input, double), *output* (double).

Parameters: *errorTolerance* (double).

When the *trigger* is zero (within the specified *errorTolerance*), then output the value from the *input* port as a discrete event. This actor controls the integration step size to accurately resolve the time at which the zero crossing occurs.

ZeroOrderHold

Ports: *input* (double), *output* (double).

Convert discrete events at the input to a continuous-time signal at the output by holding the value of the discrete event until the next discrete event arrives.

3.3.10 Discrete Event

A library of actors is provided to particularly support discrete-event models. In discrete-event models, signals consist of events placed in time, where time is a double. Events are processed in chronological order.

TimedDelay

Ports: *input* (general), *output* (type of *input*).

Parameters: *delay* (double).

Delay input events by the specified amount.

Merge

Ports: *input* (multiport, general), *output* (type of *input*).

Merge input events into a single signal.

Sampler

Ports: *input* (multiport, general), *trigger* (input, general), *output* (type of *input*).

On each *trigger* input, produce at the output the most recently seen input.

Server

Ports: *input* (general), *newServiceTime* (input, double), *output* (type of *input*).

Parameters: *serviceTime* (double).

Delay input events until they have been “served” for the specified amount of time.

SingleEvent

Ports: *output* (type of *value*).

Parameters: *time* (double), *value* (general).

Produce a single event with the specified time and value.

TimeGap

Ports: *input* (general), *output* (double).

Produce at the output the amount of time between input events.

Timer

Ports: *input* (double), *output* (type of *value*).

Parameters: *value* (general).

Given an input time value, produce *value* on the output that amount of time in the future.

VariableDelay

Ports: *input* (general), *delay* (input, double), *output* (type of *input*).

Parameters: *defaultDelay* (double).

Delay input events by the specified amount.

WaitingTime

Ports: *waiter* (input, general), *waitee* (input, general), *output* (double).

Measure the amount of time that one event (arriving on *waiter*) has to wait for an event to arrive on *waitee*. There is an output event for every event that arrives on *waiter*, where the value of that output is the time spent waiting, and the time of the output is time of the arriving *waitee* event.

3.4 Data Polymorphism

A data polymorphic actor is one that can operate on any of a number of input data types. For example, AddSubtract can accept any type of input. Addition and subtraction are possible on any type of token because they are defined in the base class Token.

Figure 3.4 shows the methods defined in the base class Token. All data exchanged between actors in Ptolemy is wrapped in an instance of Token (or more precisely, in an instance of a class derived from Token). Notice that add() and subtract() are methods of this base class. This makes it easy to implement a data polymorphic adder.

It is instructive to examine the code in an actor that performs data polymorphic operations. The

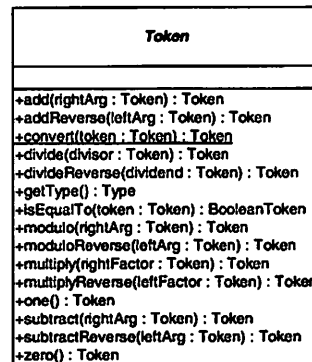

FIGURE 3.4. The Token class defines a polymorphic interface that includes basic arithmetic operations.

fire() method of the AddSubtract actor is shown in figure 3.5. In this code, we first iterate through the channels of *plus* input. The first token read (by the get() method) is assigned to sum. Subsequently, the polymorphic add() method of that token is used to add additional tokens. The second iteration, over the channels at the *minus* input port, is slightly trickier. If no tokens were read from the *plus* input, then the variable sum is initialized by calling the polymorphic zero() method of the first token read at the *minus* port. The zero() method returns whatever a zero value is for the token in question.

Not all classes derived from Token override all its methods. For example, StringToken overrides add() but not subtract(). Adding strings means simply concatenating them, but it is hard to assign a reasonable meaning to subtraction. Thus, if AddSubtract is used on strings, then the *minus* port must not ever receive tokens. It may be simply left disconnected, in which case minus.getWidth() returns zero. If the subtract() method of a StringToken is called, then a runtime exception will be thrown.

3.5 Domain Polymorphism

Most actors access their ports as shown in figure 3.5, using the hasToken(), get(), and send() methods. Those methods are polymorphic, in that their exact behavior depends on the domain. For example, get() in the CSP domain causes a rendezvous to occur, which means that the calling thread is suspended until another thread sends data to the same port (using, for example, the send() method on one of its ports). Correspondingly, a call to send() causes the calling thread to suspend until some other thread calls a corresponding get(). In the PN domain, by contrast, send() returns immediately (if there is room in the channel buffers), and only get() causes the calling thread to suspend.

Each domain has slightly different behavior associated with hasToken(), get(), send() and other methods of ports. The actor, however, does not really care. The fire() method shown in figure 3.5 will work for any reasonable implementation of these methods. Thus, the AddSubtract actor is domain polymorphic.

```
public void fire() throws IllegalArgumentException {
    Token sum = null;
    for (int i = 0; i < plus.getWidth(); i++) {
        if (plus.hasToken(i)) {
            if (sum == null) {
                sum = plus.get(i);
            } else {
                sum = sum.add(plus.get(i));
            }
        }
    }
    for (int i = 0; i < minus.getWidth(); i++) {
        if (minus.hasToken(i)) {
            Token in = minus.get(i);
            if (sum == null) {
                sum = in.zero();
            }
            sum = sum.subtract(in);
        }
    }
    if (sum != null) {
        output.send(0, sum);
    }
}
```

FIGURE 3.5. The fire() method of the AddSubtract shows the use of polymorphic add() and subtract() methods in the Token class (see figure 3.4).

Domains also have different behavior with respect to when the `fire()` method is invoked. In process-oriented domains, such as CSP and PN, a thread is created for each actor, and an infinite loop is created to repeatedly invoke the `fire()` method. Moreover, in these domains, `hasToken()` always returns *true*, since you can call `get()` on a port and it will not return until there is data available. In the DE domain, the `fire()` method is invoked only when there are new inputs that happen to be the oldest ones in the systems, and `hasToken()` returns *true* only if there is new data on the input port. The design of actors for multiple domains is covered in the *Designing Actors* chapter.

4

Designing Actors

Authors: Christopher Hylands
Edward A. Lee
Jie Liu
Xiaojun Liu
Steve Neuendorffer
Yuhong Xiong

4.1 Overview

Ptolemy is about component-based design. The domains define the semantics of the interaction between components. This chapter explains the common, domain-independent principles in the design of components that are actors. Actors are components with input and output that at least conceptually operate concurrently with other actors.

As explained in the previous chapter, some actors are designed to be domain polymorphic, meaning that they can operate in various domains. Others are domain specific. Refer to the domain chapters in part 3 for domain-specific information relevant to the design of actors. This chapter explains how to design actors so that they are maximally domain polymorphic. As also explained in the previous chapter, many actors are also data polymorphic. This means that they can operate on a wide variety of token types. Domain and data polymorphism help to minimize the amount of duplicated code when writing actors.

Code duplication can be also be avoided using object-oriented inheritance. Inheritance can also be used to enforce consistency across a set of classes. Figure 3.1, shows a UML static-structure diagram for an actor library. Three base classes, Source, Sink, and Transformer, exist to ensure consistent naming of ports and to avoid duplicating code associated with those ports. Since most actors in the library extend these base classes, users of the library can guess that an input port is named “input” and an output port is named “output,” and they will probably be right. Using base classes avoids input ports named “in” or “inputSignal” or something else. This sort of consistency helps to promote re-use of actors because it makes them easier to use. Thus, we recommend using a reasonably deep class hierar-

chy to promote consistency.

4.2 Anatomy of an Actor

The basic structure of an actor is shown in figure 4.1. In that figure, keywords in bold are features of Ptolemy II that are briefly described here and described in more detail in the chapters of part 2. Italic text would be substituted with something else in an actual actor definition.

We will go over this structure in detail in this chapter. The source code for existing Ptolemy II actors, located mostly in \$PTII/ptolemy/actor/lib, should also be viewed as a key resource.

4.2.1 Ports

By convention, ports are public members of actors. They represent a set of input and output *channels* through which tokens may pass to other ports. Figure 4.1 shows a single port *portName* that is an instance of TypedIOPort, declared in the line

```
public TypedIOPort portName;
```

Most ports in actors are instances of TypedIOPort, unless they require domain-specific services, in which case they may be instances of a domain-specific subclass such as DEIOPort. The port is actually created in the constructor by the line

```
portName = new TypedIOPort(this, "portName", true, false);
```

The first argument to the constructor is the container of the port, this actor. The second is the name of the port, which can be any string, but by convention, is the same as the name of the public member. The third argument specifies whether the port is an input (it is in this example), and the fourth argument specifies whether it is an output (it is not in this example). There is no difficulty with having a port that is both an input and an output, but it is rarely useful to have one that is neither.

Multiports and Single Ports. A port can be a single port or a multiport. By default, it is a single port. It can be declared to be a multiport with a statement like

```
portName.setMultiport(true);
```

All ports have a *width*, which corresponds to the number of channels the port represents. If a port is not connected, the width is zero. If a port is a single port, the width can be zero or one. If a port is a multiport, the width can be larger than one.

Reading and Writing. Data (encapsulated in a *token*) can be sent to a particular channel of an output multiport with the syntax

```
portName.send(channelNumber, token);
```

where *channelNumber* is the number of the channel (beginning with 0 for the first channel). The width of the port, the number of channels, can be obtained with the syntax

```

/** Javadoc comment for the class. */
public class ClassName extends BaseClass implements MarkerInterface {

    /** Javadoc comment for constructor. */
    public ClassName(CompositeEntity container, String name)
        throws NameDuplicationException, IllegalActionException {
        super(container, name);
        // Create and configure ports, e.g. ...
        portName = new TypedIOPort(this, "portName", true, false);
        // Create and configure parameters, e.g. ...
        parameterName = new Parameter(this, "parameterName");
        parameterName.setTypeEquals(BaseType.DOUBLE);
    }

    ////////////////////////////////////////////////////
    ///                               ports and parameters          ///
    ////////////////////////////////////////////////////

    /** Javadoc comment for port. */
    public TypedIOPort portName;

    /** Javadoc comment for parameter. */
    public Parameter parameterName;

    ////////////////////////////////////////////////////
    ///                               public methods                ///
    ////////////////////////////////////////////////////

    /** Javadoc comment for fire method. */
    public void fire() {
        super.fire();
        ... read inputs and produce outputs ...
    }

    /** Javadoc comment for initialize method. */
    public void initialize() {
        super.initialize();
        ... initialize local variables ...
    }

    /** Javadoc comment for prefire method. */
    public boolean prefire() {
        ... determine whether firing should proceed and return false if not ...
        return super.prefire();
    }

    /** Javadoc comment for postfire method. */
    public boolean postfire() {
        ... update persistent state ...
        ... determine whether firing should continue to next iteration and return false if not ...
        return super.postfire();
    }

    /** Javadoc comment for wrapup method. */
    public void wrapup() {
        super.wrapup();
        ... display final results ...
    }
}

```

FIGURE 4.1. Anatomy of an actor.

```
int width = portName.getWidth();
```

If the port is unconnected, then the token is not sent anywhere. The `send()` method does not complain. Note that in general, if the channel number refers to a channel that does not exist, the `send()` method does not complain.

A token can be sent to all output channels of a port (or none if there are none) with the syntax

```
portName.broadcast(token);
```

If the port is not a multiport then there is only one channel and it is more efficient to use the syntax

```
portName.send(0, token);
```

A token can be read from a channel with the syntax

```
Token token = portName.get(channelNumber);
```

You can query an input port to see whether such a `get()` will succeed (whether a token is available or can be made available) with the syntax

```
boolean tokenAvailable = portName.hasToken(channelNumber);
```

You can also query an output port to see whether a `send()` will succeed using

```
boolean spaceAvailable = portName.hasRoom(channelNumber);
```

although with most current domains, the answer is always true. Note that the `get()`, `hasRoom()` and `hasToken()` methods throw `IllegalArgumentException` if the channel is out of range, but `send()` just silently returns.

Ptolemy II includes a sophisticated type system, described fully in the Type System chapter. This type system supports specification of type constraints in the form of inequalities between types. These inequalities can be easily understood as representing the possibility of lossless conversion. Type *a* is less than type *b* if an instance of *a* can be losslessly converted to an instance of *b*. For example, `IntToken` is less than `DoubleToken`, which is less than `ComplexToken`. However, `LongToken` is not less than `DoubleToken`, and `DoubleToken` is not less than `LongToken`, so these two types are said to be *incomparable*.

Suppose that you wish to ensure that the type of an output is greater than or equal to the type of a parameter. You can do so by putting the following statement in the constructor:

```
portName.setTypeAtLeast(parameterName);
```

This is called a *relative type constraint* because it constrains the type of one object relative to the type of another. Another form of relative type constraint forces two objects to have the same type, but without specifying what that type should be:

```
portName.setTypeSameAs(parameterName);
```

These constraints could be specified in the other order,

```
parameterName.setTypeSameAs(portName);
```

which obviously means the same thing, or

```
parameterName.setTypeAtLeast(portName);
```

which is not quite the same.

Another common type constraint is an *absolute type constraint*, which fixes the type of the port (i.e. making it monomorphic rather than polymorphic),

```
portName.setTypeEquals(BaseType.DOUBLE);
```

The above line declares that the port can only handle doubles. Another form of absolute type constraint imposes an upper bound on the type,

```
portName.setTypeAtMost(BaseType.COMPLEX);
```

which declares that any type that can be losslessly converted to ComplexToken is acceptable.

If no type constraints are given for any ports of an actor, then by default, the output ports are constrained to have at least the type(s) of the input ports. If *any* type constraints are given for any ports in the actor, then this default is not applied for any of the other ports. Thus, if you specify any type constraints, you should specify all of them. For full details of the type system, see the Type System chapter.

Examples. To be concrete, consider first the code segment shown in figure 4.2, from the Transformer class in the ptolemy.actor.lib package. This actor is a base class for actors with one input and one output. The code shows two ports, one that is an input and one that is an output. By convention, the Javadoc¹ comments indicate type constraints on the ports, if any. If the ports are multiports, then the Javadoc comment will indicate that. Otherwise, they are assumed to be single ports. Derived classes may change this, making the ports into multiports, in which case they should document this fact in the class comment. Derived classes may also set the type constraints on the ports.

An extension of Transformer is shown in figure 4.3, the Scale actor. This actor produces an output token on each firing with a value that is equal to a scaled version of the input. The actor is polymorphic in that it can support any token type that supports multiplication by the *factor* parameter. In the constructor, the output type is constrained to be at least as general as both the input and the *factor* parameter.

Notice in figure 4.3 how the fire() method uses hasToken() to ensure that no output is produced if there is no input. Furthermore, only one token is consumed from each input channel, even if there is more than one token available. This is generally the behavior of domain-polymorphic actors. Notice also how it uses the multiply() method of the Token class. This method is polymorphic. Thus, this scale

1. Javadoc is a program that generates HTML documentation from Java files based on comments enclosed in `/** ... */`.

These constraints could be specified in the other order,

```
parameterName.setTypeSameAs(portName);
```

which obviously means the same thing, or

```
parameterName.setTypeAtLeast(portName);
```

which is not quite the same.

Another common type constraint is an *absolute type constraint*, which fixes the type of the port (i.e. making it monomorphic rather than polymorphic),

```
portName.setTypeEquals(BaseType.DOUBLE);
```

The above line declares that the port can only handle doubles. Another form of absolute type constraint imposes an upper bound on the type,

```
portName.setTypeAtMost(BaseType.COMPLEX);
```

which declares that any type that can be losslessly converted to ComplexToken is acceptable.

If no type constraints are given for any ports of an actor, then by default, the output ports are constrained to have at least the type(s) of the input ports. If *any* type constraints are given for any ports in the actor, then this default is not applied for any of the other ports. Thus, if you specify any type constraints, you should specify all of them. For full details of the type system, see the Type System chapter.

Examples. To be concrete, consider first the code segment shown in figure 4.2, from the Transformer class in the ptolemy.actor.lib package. This actor is a base class for actors with one input and one output. The code shows two ports, one that is an input and one that is an output. By convention, the Javadoc¹ comments indicate type constraints on the ports, if any. If the ports are multiports, then the Javadoc comment will indicate that. Otherwise, they are assumed to be single ports. Derived classes may change this, making the ports into multiports, in which case they should document this fact in the class comment. Derived classes may also set the type constraints on the ports.

An extension of Transformer is shown in figure 4.3, the Scale actor. This actor produces an output token on each firing with a value that is equal to a scaled version of the input. The actor is polymorphic in that it can support any token type that supports multiplication by the *factor* parameter. In the constructor, the output type is constrained to be at least as general as both the input and the *factor* parameter.

Notice in figure 4.3 how the fire() method uses hasToken() to ensure that no output is produced if there is no input. Furthermore, only one token is consumed from each input channel, even if there is more than one token available. This is generally the behavior of domain-polymorphic actors. Notice also how it uses the multiply() method of the Token class. This method is polymorphic. Thus, this scale

1. Javadoc is a program that generates HTML documentation from Java files based on comments enclosed in `/** ... */`.

actor can operate on any token type that supports multiplication, including all the numeric types and matrices.

4.2.2 Parameters

Like ports, by convention, parameters are public members of actors. Figure 4.3 shows a parameter *factor* that is an instance of *Parameter*, declared in the line

```
public Parameter factor;
```

and created in the line

```
factor = new Parameter(this, "factor", new IntToken(1));
```

The third argument to the constructor, which is optional, is a default value for the parameter. In this example, the *factor* parameter defaults to the integer one.

As with ports, you can specify type constraints on parameters. The most common type constraint is to fix the type, using

```
parameterName.setTypeEquals(BaseType.DOUBLE);
```

In fact, exactly the same relative or absolute type constraints that one can specify for ports can be spec-

```
public class Transformer extends TypedAtomicActor {
    /** Construct an actor with the given container and name.
     * @param container The container.
     * @param name The name of this actor.
     * @exception IllegalArgumentException If the actor cannot be contained
     * by the proposed container.
     * @exception NameDuplicationException If the container already has an
     * actor with this name.
     */
    public Transformer(CompositeEntity container, String name)
        throws NameDuplicationException, IllegalArgumentException {
        super(container, name);
        input = new TypedIOPort(this, "input", true, false);
        output = new TypedIOPort(this, "output", false, true);
    }

    //////////////////////////////////////
    /// ports and parameters ///

    /** The input port. This base class imposes no type constraints except
     * that the type of the input cannot be greater than the type of the
     * output.
     */
    public TypedIOPort input;

    /** The output port. By default, the type of this output is constrained
     * to be at least that of the input.
     */
    public TypedIOPort output;
}
```

FIGURE 4.2. Code segment showing the port definitions in the *Transformer* class.

ified for parameters as well. But in addition, arbitrary constraints on parameter values are possible, not just type constraints. An actor is notified when a parameter value changes by having its `attributeChanged()` method called. Consider the example shown in figure 4.4, taken from the Poisson-Clock actor. This actor generates timed events according to a Poisson process. One of its parameters is *meanTime*, which specifies the mean time between events. This must be a double, as asserted in the constructor.

The `attributeChanged()` method is passed the parameter that changed. If this is *meanTime*, then this method checks to make sure that the specified value is positive, and if not, it throws an exception.

```

public class Scale extends Transformer {
    ...
    public Scale(CompositeEntity container, String name)
        throws NameDuplicationException, IllegalActionException {
        super(container, name);
        factor = new Parameter(this, "factor", new IntToken(1));

        // set the type constraints.
        output.setTypeAtLeast(input);
        output.setTypeAtLeast(factor);
    }

    //////////////////////////////////////
    ///                               ports and parameters                               ///
    //////////////////////////////////////

    /** The factor.
     * This parameter can contain any token that supports multiplication.
     * The default value of this parameter is the IntToken 1.
     */
    public Parameter factor;

    //////////////////////////////////////
    ///                               public methods                               ///
    //////////////////////////////////////

    /** Clone the actor into the specified workspace. This calls the
     * base class and then sets the type constraints.
     * @param workspace The workspace for the new object.
     * @return A new actor.
     * @exception CloneNotSupportedException If a derived class has
     * an attribute that cannot be cloned.
     */
    public Object clone(Workspace workspace)
        throws CloneNotSupportedException {
        Scale newObject = (Scale)super.clone(workspace);
        newObject.output.setTypeAtLeast(newObject.input);
        newObject.output.setTypeAtLeast(newObject.factor);
        return newObject;
    }

    /** Compute the product of the input and the <i>factor</i>.
     * If there is no input, then produce no output.
     * @exception IllegalActionException If there is no director.
     */
    public void fire() throws IllegalActionException {
        if (input.hasToken(0)) {
            Token in = input.getToken();
            Token factorToken = factor.getToken();
            Token result = factorToken.multiply(in);
            output.send(0, result);
        }
    }
}

```

FIGURE 4.3. Code segment from the Scale actor, showing the handling of ports and parameters.

A change in a parameter value sometimes has broader repercussions than just the local actor. It may, for example, impact the schedule of execution of actors. An actor can call the `invalidateSchedule()` method of the director, which informs the director that any statically computed schedule (if there is one) is no longer valid. This would be used, for example, if the parameter affects the number of tokens produced or consumed when an actor fires.

When the type of a parameter changes, the `attributeTypeChanged()` method in the actor containing that parameter will be called. The default implementation of this method in `TypedAtomicActor` is to invalidate type resolution. So parameter type change will cause type resolution to be performed in the model. This default implementation is suitable for most actors. In fact, most of the actors in the actor library do not override this method. However, if for some reason, an actor does not wish to redo type resolution upon parameter type change, the `attributeTypeChanged()` method can be overridden. But this is rarely necessary.

4.2.3 Constructors

We have seen already that the major task of the constructor is to create and configure ports and parameters. In addition, you may have noticed that it calls

```
super(container, name);
```

and that it declares that it throws `NameDuplicationException` and `IllegalActionException`. The latter is

```
public class PoissonClock extends TimedSource {
    public Parameter meanTime;
    public Parameter values;

    public PoissonClock(CompositeEntity container, String name)
        throws NameDuplicationException, IllegalActionException {
        super(container, name);
        meanTime = new Parameter(this, "meanTime", new DoubleToken(1.0));
        meanTime.setTypeEquals(BaseType.DOUBLE);
        ...
    }

    /** If the argument is the meanTime parameter, check that it is
     *  positive.
     *  @exception IllegalActionException If the meanTime value is
     *  not positive.
     */
    public void attributeChanged(Attribute attribute) throws IllegalActionException {
        if (attribute == meanTime) {
            double mean = ((DoubleToken)meanTime.getToken()).doubleValue();
            if (mean <= 0.0) {
                throw new IllegalActionException(this,
                    "meanTime is required to be positive. meanTime given: " + mean);
            }
        } else if (attribute == values) {
            ArrayToken val = (ArrayToken)(values.getToken());
            _length = val.length();
        } else {
            super.attributeChanged(attribute);
        }
    }
    ...
}
```

FIGURE 4.4. Code segment from the `PoissonClock` actor, showing the `attributeChanged()` method.

the most widely used exception, and many methods in actors declare that they can throw it. The former is thrown if the specified container already contains an actor with the specified name. For more details about exceptions, see the Kernel chapter.

4.2.4 Cloning

All actors are cloneable. A clone of an actor needs to be a new instance of the same class, with the same parameter values, but without any connections to other actors.

Consider the clone() method in figure 4.5, taken from the Scale actor. This method begins with

```
Scale newObject = (Scale) super.clone(workspace);
```

The convention in Ptolemy II is that each clone method begins the same way, so that cloning works its way up the inheritance tree until it ultimately uses the clone() method of the Java Object class. That method performs what is called a “shallow copy,” which is not sufficient for our purposes. In particular, members of the class that are references to other objects, including public members such as ports and parameters, are copied by copying the references. The NamedObj and TypedAtomicActor base classes (see the “Abstract Syntax” chapter) for most actors implement a “deep copy” so that all the contained objects are cloned, and public members reference the proper cloned objects².

Although the base classes neatly handle most aspects of the clone operation, there are subtleties

```
public class Scale extends Transformer {
    ...
    public Scale(CompositeEntity container, String name)
        throws NameDuplicationException, IllegalActionException {
        super(container, name);
        output.setTypeAtLeast(input);
        output.setTypeAtLeast(factor);
    }

    //////////////////////////////////////
    ///                               ///
    /** The factor. The default value of this parameter is the integer 1. */
    public Parameter factor;

    //////////////////////////////////////
    ///                               ///

    /** Clone the actor into the specified workspace. This calls the
     * base class and then sets the type constraints.
     * @param workspace The workspace for the new object.
     * @return A new actor.
     * @exception CloneNotSupportedException If a derived class has
     * has an attribute that cannot be cloned.
     */
    public Object clone(Workspace workspace) throws CloneNotSupportedException {
        Scale newObject = (Scale) super.clone(workspace);
        newObject.output.setTypeAtLeast(newObject.input);
        newObject.output.setTypeAtLeast(newObject.factor);
        return newObject;
    }
    ...
}
```

FIGURE 4.5. Code segment from the Scale actor, showing the clone() method.

involved with cloning type constraints. Absolute type constraints on ports and parameters are carried automatically into the clone, so clone() methods should never call setTypeEquals(). However, relative type constraints are not cloned automatically because of the difficulty of ensuring that the other object being referred to in a relative constraint is the intended one. Thus, in figure 4.5, the clone() method repeats the relative type constraints that were specified in the constructor:

```
newObject.output.setTypeAtLeast(newObject.input);
newObject.output.setTypeAtLeast(newObject.factor);
```

Note that at no time during cloning is any constructor invoked, so it is necessary to repeat in the clone() method any initialization in the constructor. For example, the clone() method in the Expression actor sets the values of a few private Variables:

```
newObject._iterationCount = 1;
newObject._time = (Variable)newObject.getAttribute("time");
newObject._iteration =
    (Variable)newObject.getAttribute("iteration");
```

4.3 Action Methods

Figure 4.1 shows a set of public methods called the *action methods* because they specify the action performed by the actor. By convention, these are given in alphabetical order in Ptolemy II Java files, but we will discuss them here in the order that they are invoked. The first to be invoked is the preinitialize() method, which is invoked exactly once before any other action method is invoked. The preinitialize() method is often used to set type constraints. After the preinitialize() method is called, type resolution happens and all the type constraints are resolved. The initialize() method is invoked next, and is typically used to initialize state variables in the actor, which generally depends on type resolution.

After the initialize() method, the actor experiences some number of *iterations*, where an iteration is defined to be exactly one invocation of prefire(), some number of invocations of fire(), and at most one invocation of postfire().

4.3.1 Initialization

The initialize() method of the Average actor is shown in figure 4.6. This data- and domain-polymorphic actor computes the average of tokens that have arrived. To do so, it keeps a running sum in a private variable _sum, and a running count of the number of tokens it has seen in a private variable _count. Both of these variables are initialized in the initialize() method. Notice that the actor also calls super.initialize(), allowing the base class to perform any initialization it expects to perform. This is essential because one of the base classes initializes the ports. An actor will almost certainly fail to run properly if super.initialize() is not called.

Note that the initialization of the Average actor does not affect, or depend on, type resolution. This

2. Be aware that the implementation of the deep copy relies on a strict naming convention. Public members that reference ports and parameters must have the same name as the object that they are referencing in order to be properly cloned.

means that the code to initialize this actor can be placed either in the `preinitialize()` method, or in the `initialize()` method. However, in some cases an actor may require part of its initialization to happen before type resolution, in the `preinitialize()` method, or part after type resolution, in the `initialize()` method. For example, an actor may need to dynamically create type constraints before each execution³. Such an actor must create its type constraints in `preinitialize()`. On the other hand, an actor may wish to produce an initial output token once at the beginning of an execution of a model. This production can only happen during `initialize()`, because data transport through ports depends on type resolution.

4.3.2 Prefire

The `prefire()` method is the only method that is invoked exactly once per iteration⁴. It returns a boolean that indicates to the director whether the actor wishes for firing to proceed. The `fire()` method of an actor should never be called until after its `prefire` method has returned true. The most common use of this method is to test a condition to see whether the actor is ready to fire.

Consider for example an actor that reads from `trueInput` if a private boolean variable `_state` is `true`, and otherwise reads from `falseInput`. The `prefire()` method might look like this:

```
public boolean prefire() throws IllegalActionException {
    if(_state) {
        if(trueInput.hasToken(0)) return true;
    } else {
        if(falseInput.hasToken(0)) return true;
    }
    return false;
}
```

It is good practice to check the superclass in case it has some reason to decline to be fired. The above

```
public class Average extends Transformer {
    ...
    public void initialize() throws IllegalActionException {
        super.initialize();
        _count = 0;
        _sum = null;
    }
    ...

    ////////////////////////////////////////
    ///                               ///

    private Token _sum;
    private int _count = 0;
}
```

FIGURE 4.6. Code segment from the Average actor, showing the `initialize()` method.

3. The need for this is relatively rare, but important. Examples include higher-order functions, which are actors that replace themselves with other subsystems, and certain actors whose ports are not created at the time they are constructed, but rather are added later. In most cases, the type constraints of an actor do not change and are simply specified in the constructor.
4. Some domains invoke the `fire()` method only once per iteration, but others will invoke it multiple times (searching for global convergence to a solution, for example).

example becomes:

```
public boolean prefire() throws IllegalActionException {
    if(_state) {
        if(trueInput.hasToken(0)) return super.prefire();
    } else {
        if(falseInput.hasToken(0)) return super.prefire();
    }
    return false;
}
```

The `prefire()` method can also be used to perform an operation that will happen exactly once per iteration. Consider the `prefire` method of the Bernoulli actor in figure 4.7:

```
public boolean prefire() throws IllegalActionException {
    if (_random.nextDouble() <
        ((DoubleToken) (trueProbability.getToken())).doubleValue()) {
        _current = true;
    } else {
        _current = false;
    }
}
```

```
public class Bernoulli extends RandomSource {
    public Bernoulli(CompositeEntity container, String name)
        throws NameDuplicationException, IllegalActionException {
        super(container, name);

        output.setTypeEquals(BaseType.BOOLEAN);

        trueProbability = new Parameter(this, "trueProbability", new DoubleToken(0.5));
        trueProbability.setTypeEquals(BaseType.DOUBLE);
    }

    public Parameter trueProbability;

    public void fire() {
        try {
            super.fire();
            output.send(0, new BooleanToken(_current));
        } catch (IllegalActionException ex) {
            // Should not be thrown because this is an output port.
            throw new InternalErrorException(ex.getMessage());
        }
    }

    public boolean prefire() throws IllegalActionException {
        if (_random.nextDouble() < ((DoubleToken) (trueProbability.getToken())).doubleValue()) {
            _current = true;
        } else {
            _current = false;
        }
        return super.prefire();
    }

    private boolean _current;
}
```

FIGURE 4.7. Code for the Bernoulli actor, which is not data polymorphic.

```
    }  
    return super.prefire();  
}
```

This method selects a new boolean value that will correspond to the token creating during each firing of that iteration.

4.3.3 Fire

The `fire()` method is the main point of execution and is generally responsible for reading inputs and producing outputs. It may also read the current parameter values, and the output may depend on them. Things to remember when writing `fire()` methods are:

- To get data polymorphism, use the methods of the `Token` class for arithmetic whenever possible (see the `Data Package` chapter). Consider for example the `Average` actor, shown in figure 4.9. Notice the use of the `add()` and `divide()` methods of the `Token` class to achieve data polymorphism.
- When data polymorphism is not practical or not desired, then it is usually easiest to use the `setTypeEquals()` to define the type of input ports. The type system will assure that you can safely cast the tokens that you read to the type of the port. Consider again the `Average` actor shown in figure 4.9. This actor declares the type of its `reset` input port to be `BaseType.BOOLEAN`. In the `fire()` method, the input token is read and cast to a `BooleanToken`. The type system ensures that no cast error will occur. The same can be done with a parameter, as with the `Bernoulli` actor shown in figure 4.9.
- A domain-polymorphic actor cannot assume that there is data at all the input ports. Most domain-polymorphic actors will read at most one input token from each port, and if there are sufficient inputs, produce exactly one token on each output port.
- Some domains invoke the `fire()` method multiple times, iterating towards a converged solution. Thus, each invocation can be thought of as doing a tentative computation with tentative inputs and producing tentative outputs. Thus, the `fire()` method should not update persistent state. Instead, that should be done in the `postfire()` method, as discussed in the next section.

4.3.4 Postfire

The `postfire()` method has two tasks:

- updating persistent state, and
- determining whether the execution of an actor is complete.

Consider the `fire()` and `postfire()` methods of the `Average` actor in figure 4.9. Notice that the persistent state variables `_sum` and `_count` are not updated in `fire()`. Instead, they are shadowed by `_latestSum` and `_latestCount`, and updated in `postfire()`.

The return value of `postfire()` is a boolean that indicates to the director whether execution of the actor is complete. By convention, the director should avoid iterating further an actor that returns false. Consider the two examples shown in figure 4.9. These are base classes for source actors (those with no input ports).

`SequenceSource` is a base class for actors that output sequences. Its key feature is a parameter *firingCountLimit*, which specifies a limit on the number of iterations of the actor. When this limit is reached, the `postfire()` method returns false. Thus, this parameter can be used to define sources of finite sequences.

```

public class Average extends Transformer {

    ... constructor ...

    //////////////////////////////////////
    ///                               ///
    public TypedIOPort reset;

    //////////////////////////////////////
    ///                               ///
    ... clone method ...

    public void fire() throws IllegalActionException {
        _latestSum = _sum;
        _latestCount = _count + 1;
        // Check whether to reset.
        for (int i = 0; i < reset.getWidth(); i++) {
            if (reset.hasToken(i)) {
                BooleanToken r = (BooleanToken)reset.get(i);
                if (r.booleanValue()) {
                    // Being reset at this firing.
                    _latestSum = null;
                    _latestCount = 1;
                }
            }
        }
        if (input.hasToken(0)) {
            Token in = input.get(0);
            if (_latestSum == null) {
                _latestSum = in;
            } else {
                _latestSum = _latestSum.add(in);
            }
            Token out = _latestSum.divide(new IntToken(_latestCount));
            output.send(0, out);
        }
    }

    public void initialize() throws IllegalActionException {
        super.initialize();
        _count = 0;
        _sum = null;
    }

    public boolean postfire() throws IllegalActionException {
        _sum = _latestSum;
        _count = _latestCount;
        return super.postfire();
    }

    //////////////////////////////////////
    ///                               ///
    private members

    private Token _sum;
    private Token _latestSum;
    private int _count = 0;
    private int _latestCount;
}

```

FIGURE 4.8. Code segment from the Average actor, showing the action methods.

TimedSource is similar, except that instead of specifying a limit on the number of iterations, it specifies a limit on the current model time. When that limit is reached, the `postfire()` method returns false.

4.3.5 Wrapup

The `wrapup()` method is invoked exactly once at the end of an execution, unless an exception occurs during execution. It is used typically for displaying final results.

```

public class SequenceSource extends Source implements SequenceActor {
    public SequenceSource(CompositeEntity container, String name)
        throws NameDuplicationException, IllegalActionException {
        super(container, name);
        firingCountLimit = new Parameter(this, "firingCountLimit", new IntToken(0));
        firingCountLimit.setTypeEquals(BaseType.INT);
    }

    public Parameter firingCountLimit;

    ...

    public boolean postfire() throws IllegalActionException {
        if (_firingCountLimit != 0) {
            _iterationCount++;
            if (_iterationCount == ((IntToken)firingCountLimit.getToken()).intValue()) {
                return false;
            }
        }
        return true;
    }

    protected int _firingCountLimit;
    protected int _iterationCount = 0;
}

public class TimedSource extends Source implements TimedActor {

    public TimedSource(CompositeEntity container, String name)
        throws NameDuplicationException, IllegalActionException {
        super(container, name);
        stopTime = new Parameter(this, "stopTime", new DoubleToken(0.0));
        stopTime.setTypeEquals(BaseType.DOUBLE);
    }

    public Parameter stopTime;

    ...

    public boolean postfire() throws IllegalActionException {
        double time = ((DoubleToken)stopTime.getToken()).doubleValue();
        if (time > 0.0 && getDirector().getCurrentTime() >= time) {
            return false;
        }
        return true;
    }
}

```

FIGURE 4.9. Code segments from the SequenceSource and TimedSource base classes.

4.4 Time

An actor whose behavior depends on current model time should implement the `TimedActor` interface. This is a marker interface (with no methods). Implementing this interface alerts the director that the actor depends on time. Domains that have no meaningful notion of time can reject such actors.

An actor can access current model time with the syntax

```
double currentTime = getDirector().getCurrentTime();
```

Notice that although the director has a public method `setCurrentTime()`, an actor should never use it. Typically, only another enclosing director will call this method.

An actor can request an invocation at a future time using the `fireAt()` method of the director. This method returns immediately (for a correctly implemented director). It takes two arguments, an actor and a time. The director is responsible for iterating the specified actor at the specified time. This method can be used to get a source actor started, and to keep it operating. In its `initialize()` method, it can call `fireAt()` with a zero time. Then in each invocation of `postfire()`, it calls `fireAt()` again. Notice that the call should be in `postfire()` not in `fire()` because a request for a future firing is persistent state.

4.5 Code Format

Ptolemy software follows fairly rigorous conventions for code formatting. Although many of these conventions are arbitrary, the resulting consistency makes reading the code much easier, once you get used to the conventions. We recommend that if you extend Ptolemy II in any way, that you follow these conventions. To be included in future versions of Ptolemy II, the code *must* follow the conventions.

A template that corresponds to these rules can be found in `$(PTII)/doc/coding/templates`. There are also templates for other common files. In general, if you have questions that are not covered here, then consult the template or highly rated code.

Several useful tools are provided in the `$PTII/util/testsuite` directory to help enforce the standards. `ptjavastyle.el` is a lisp module for GNU Emacs that has appropriate indenting rules. `jindent` is a unix script that uses Emacs and the above module to properly indent many files at once. `ptspell` is a script that checks Java code for proper spelling. It properly handles names with Embedded Capitalization and has a list of author names. `chkjava` is a Unix script for checking various other potentially bad things in Java code, such as debugging code, and FIXME's.

4.5.1 Indentation

Nested statements should be indented 4 characters, as in:

```
if (container != null) {
    Manager manager = container.getManager();
    if (manager != null) {
        manager.requestChange(change);
    }
}
```

Closing brackets should be on a line by themselves, aligned with the beginning of the line that contains the open bracket. Tabs are 8 space characters, not a Tab character. The reason for this is that code becomes unreadable when the Tab character is interpreted differently by different programs. Do not override this in your text editor. Long lines should be broken up into many small lines. The easiest places to break long lines are usually just before operators, with the operator appearing on the next line. Long strings can be broken up using the + operator in Java, with the + starting the next line. Continuation lines are indented by 8 characters, as in the throws clause of the constructor in figure 4.1.

4.5.2 Spaces

Use a space after each comma:

```
Right: foo(a, b);
Wrong: foo(a,b);
```

Use spaces around operators such as plus, minus, multiply, divide or equals signs, and after semicolons:

```
Right: a = b + 1;
Wrong: a=b+1;
Right: for(i = 0; i < 10; i += 2)
Wrong: for(i=0 ;i<10;i+=2)
```

4.5.3 Comments

Comments should be complete sentences and complete thoughts, capitalized at the beginning and with a period at the end. Spelling and grammar should be correct. Comments should include honest information about the limitations of the object definition.

Comments for base class methods that are intended to be overridden should include information about what the method generally does, along with a description of how the base class implements it. Comments in derived classes for methods that override the base class should copy the general description from the base class, and then document the particular implementation. In general comments with FIXME's and implementation details should be used liberally in the code, but never in the interface description.

4.5.4 Names

In general, the names of classes, methods and members should consist of complete words separated using internal capitalization⁵. Class names, and only class names have their first letter capitalized, as in AtomicActor. Method and member names are not capitalized, except at internal word boundaries, as in getContainer(). Protected or private members and methods are preceded by a leading underscore "_" as in _protectedMethod().

Static final constants should be in uppercase, with words separated by underscores, as in INFINITE_CAPACITY. A leading underscore should be used if the constant is protected or private.

Package names should be short and not capitalized, as in "de" for the discrete-event domain.

In Java, there is no limit to name sizes (as it should be). Do not hesitate to use long names.

5. Yes, there are exceptions (NamedObj, CrossRefList, IOPort). Many discussions dealt with these names, and we still regret not making them complete words.

4.5.5 Exceptions

A number of exceptions are provided in the `ptolemy.kernel.util` package. Use these exceptions when possible because they provide convenient arguments of type `Nameable` that identify the source of the exception by name in a consistent way.

A key decision you need to make is whether to use a compile-time exception or a run-time exception. A run-time exception is one that implements the `RuntimeException` interface. Run-time exceptions are more convenient in that they do not need to be explicitly declared by methods that throw them. However, this can have the effect of masking problems in the code.

The convention we follow is that a run-time exception is acceptable only if the cause of the exception can be tested for prior to calling the method. This is called a *testable precondition*. For example, if a particular method will fail if the argument is negative, and this fact is documented, then the method can throw a run-time exception if the argument is negative. On the other hand, consider a method that takes a string argument and evaluates it as an expression. The expression may be malformed, in which case an exception will be thrown. Can this be a run-time exception? No, because to determine whether the expression is malformed, you really need to invoke the evaluator. Making this a compile-time exception forces the caller to explicitly deal with the exception, or to declare that it too throws the same exception. In general, we prefer to use compile-time exceptions wherever possible.

When throwing an exception, the detail message should be a complete sentence that includes a string that fully describes what caused the exception. For example

```
throw IllegalArgumentException(this,
    "Cannot append an object of type: "
    + obj.getClass().getName() +
    + "because it does not implement Cloneable.");
```

Note that the exception not only gives a way to identify the objects that caused the exception, but also why the exception occurred. There is no need to include in the message an identification of the “this” object passed as the first argument to the exception constructor. That object will be identified when the exception is reported to the user.

4.5.6 Javadoc

Javadoc is a program distributed with Java that generates HTML documentation files from Java source code files. Javadoc comments begin with “/**” and end with “*/”. The comment immediately preceding a method, member, or class documents that member, method, or class. Ptolemy II classes include Javadoc documentation for all classes and all public and protected members and methods. Private members and methods need not be documented. Documentation can include embedded HTML formatting. For example, by convention, in actor documentation, we set in italics the names of the ports and parameters using the syntax

```
/** In this actor, inputs are read from the <i>input</i> port ... */
```

By convention, method names are set in the default font, but followed by empty parentheses, as in

```
/** The fire() method is called when ... */
```

The parentheses are empty even if the method takes arguments. The arguments are not shown. If the method is overloaded (has several versions with different argument sets), then the text of the documentation needs to distinguish which version is being used.

It is common in the Java community to use the following style for documenting methods:

```
/** Sets the expression of this variable.
 * @param expression The expression for this variable.
 */
public void setExpression(String expression) {
    ...
}
```

We use instead the imperative tense, as in

```
/** Set the expression of this variable.
 * @param expression The expression for this variable.
 */
public void setExpression(String expression) {
    ...
}
```

The reason we do this is that our sentence is a well-formed, grammatical English sentence, while the usual convention is not (it is missing the subject). Moreover, calling a method is a command “do this,” so it seems reasonable that the documentation say “Do this.” The use of imperative tense has a large impact on how interfaces are documented, especially when using the Listener design pattern. For instance, the `java.awt.event.ItemListener` interface has the method:

```
/**
 * Invoked when an item has been selected or deselected.
 * The code written for this method performs the operations
 * that need to occur when an item is selected (or deselected).
 */
void itemStateChanged(ItemEvent e);
```

A naive attempt to rewrite this in imperative tense might result in:

```
/**
 * Notify this object that an item has been selected or deselected.
 */
void itemStateChanged(ItemEvent e);
```

However, this sentence does not capture what the method does. The method may be called *in order to* notify the listener, but the *listener* does not “notify this object”. The correct way to concisely document this method in imperative tense (and with meaningful names) is:

```
/**
 * React to the selection or deselection of an item.
 */
```

```
void itemStateChanged(ItemEvent event);
```

The annotation for the arguments (the @param statement) is not a complete sentence, since it is usually presented in tabular format. However, we do capitalize it and end it with a period.

Exceptions that are thrown by a method need to be identified in the Javadoc comment. An @exception tag should read like this:

```
* @exception MyException If such and such occurs.
```

Notice that the body always starts with "If", not "Thrown if", or anything else. Just look at the Javadoc output to see why this occurs. In the case of an interface or base class that does not throw the exception, use the following:

```
* @exception MyException Not thrown in this base class. Derived
* classes may throw it if such and such happens.
```

The exception still has to be declared so that derived classes can throw it, so it needs to be documented as well.

The Javadoc program gives extensive diagnostics when run on a source file. Our policy is to format the comments until there are no Javadoc warnings.

4.5.7 Code Organization

The basic file structure that we use follows the outline in figure 4.1, preceded by a one-line description of the file and a copyright notice. The key points to note about this organization are:

- The file is divided into sections with highly visible delimiters. The sections contain constructors, ports and parameters (and other public members, if there are any), public methods, protected methods, protected members, private methods, and private members, in that order. Note in particular that although it is customary in the Java community to list private members at the beginning of a class definition, we put them at the end. They are not part of the public interface, and thus should not be the first thing you see.
- Within each section, methods appear in alphabetical order, in order to easily search for a particular method. If you wish to group methods together, try to name them so that they have a common prefix. Static methods are generally mixed with non-static methods.

5

MoML

Authors: *Edward A. Lee*
 Steve Neuendorffer

5.1 Introduction

Ptolemy II models might be *simulations* (executable models of some other system) or *implementations* (the system itself). They might be classical computer programs (applications), or any of a number of network-integrated programs (applets, servlets, or CORBA services, for example).

Models can be specified in a number of ways. You can write Java code that instantiates components, parameterizes them, and interconnects them. Or you can use Vergil (see the Vergil chapter above) to graphically construct models. Vergil stores models in ASCII files using an XML schema called MoML. MoML (which stands for Modeling Markup Language) is the primary persistent file format for Ptolemy II models. It is also the primary mechanism for constructing models whose definition and execution is distributed over the network.

This chapter explains MoML. Most users will not need to edit MoML files directly. Use Vergil instead. Occasionally, however, it is useful to examine and/or edit MoML files directly.

MoML is a modeling markup schema in the Extensible Markup Language (XML). It is intended for specifying interconnections of parameterized components. A MoML file can be executed as an application using any of the following commands,

```
ptolemy filename.xml
ptexecute filename.xml
vergil filename.xml
moml configuration.xml filename.xml
```

These commands are defined in the directory `$PTII/bin`, which must be in your path¹, where `$PTII` is the location of the Ptolemy II installation. In all cases, the filename can be replaced by a URL. The `ptolemy` command assumes that the file defines an executable Ptolemy II model, and opens a control

panel to execute it. The `ptexecute` command executes it without a control panel. The `vergil` command opens a graphical editor to edit and execute the model. The `moml` command uses the specified configuration file (a MoML file containing a Ptolemy II configuration) to invoke some set of customized views or editors on the model. The filename extension can be “.xml” or “.moml” for MoML files. And the same XML file can be used in an applet².

To get a quick start, try entering the following into a file called `test.xml` (This file is also available as `$PTII/ptolemy/moml/demo/test.xml`):

```
<?xml version="1.0" standalone="no"?>
<!DOCTYPE entity PUBLIC "-//UC Berkeley//DTD MoML 1//EN"
    "http://ptolemy.eecs.berkeley.edu/xml/dtd/MoML_1.dtd">
<entity name="test" class="ptolemy.actor.TypedCompositeActor">
  <property name="director"
    class="ptolemy.domains.sdf.kernel.SDFDirector"/>
  <entity name="ramp" class="ptolemy.actor.lib.Ramp"/>
  <entity name="plot" class="ptolemy.actor.gui.SequencePlotter"/>
  <relation name="r" class="ptolemy.actor.TypedIORelation"/>
  <link port="ramp.output" relation="r"/>
  <link port="plot.input" relation="r"/>
</entity>
```

This code defines a model in a top-level entity called “test”. By convention, we use the same name for the top-level model and the file in which it resides. The top-level model is an instance of the Ptolemy II class `ptolemy.actor.TypedCompositeActor`. It contains a director, two entities, a relation, and two links. The model is depicted in figure 5.1, where the director is not shown. It can be run using the command

```
ptolemy test.xml
```

You should get a window looking like that in figure 5.2. Enter “10” in the iterations box and hit the “Go” button to execute the model for 10 iterations (leaving the default “0” in the iterations box executes it forever, until you hit the “Stop” button).

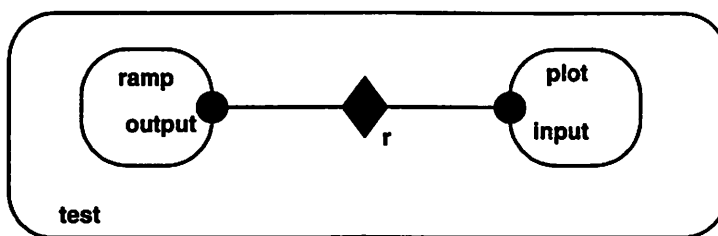

FIGURE 5.1. Simple example in the file `$PTII/ptolemy/moml/demo/test.xml`.

1. These commands are executed this way on Unix systems and on Windows systems with Cygwin installed. On other configurations, the equivalent commands are invoked in some other way.
2. An *applet* is a Java program that is downloaded from a web server by a browser and executed in the client's computer (usually within a plug-in for the browser).

The structure of the above MoML text is explained in detail in this chapter. A more interesting example is given in the appendix to this chapter. You may wish to refer to that example as you read about the details. The next chapter explains how to bypass MoML and write applets directly. The chapter after that describes the actors libraries that are included in the current Ptolemy II version.

5.2 MoML Principles

The key features of MoML include:

- *Web integration.* MoML is an XML schema. XML, the popular *extensible markup language*[89], provides a standard syntax and a standard way of defining the content within that syntax. The syntax is a subset of SGML[90], and is similar to HTML. It is intended for use on the Internet, and is intended for precisely this sort of specialization into schemas. File references are via URIs (in practice, URLs), both relative and absolute, so MoML is equally comfortable working in applets and applications.
- *Implementation independence.* MoML is designed to work with a variety of tools. A modeling tool that reads MoML files is expected to provide a class loader in some form. Given the name of a class, and possibly a URL for the class definition, the class loader must be able to instantiate it. Classes might be defined in MoML or in some base language such as Java. In Java, the class loader could be that built in to the JVM. In C++ or other languages, the class loader would have to be implemented by the modeling tool. Ptolemy II can be viewed as a reference implementation of a MoML tool that uses Java as its base language.
- *Extensibility.* Components can be parameterized in two ways. First, they can have named properties with string values. Second, they can be associated with an external configuration file that can be in any format understood by the component. Typically, the configuration will be in some other XML schema, such as PlotML or SVG (scalable vector graphics).
- *Classes and inheritance.* Components can be defined in MoML as classes which can then be instantiated in a model. Components can extend other components through an object-oriented inheritance mechanism.

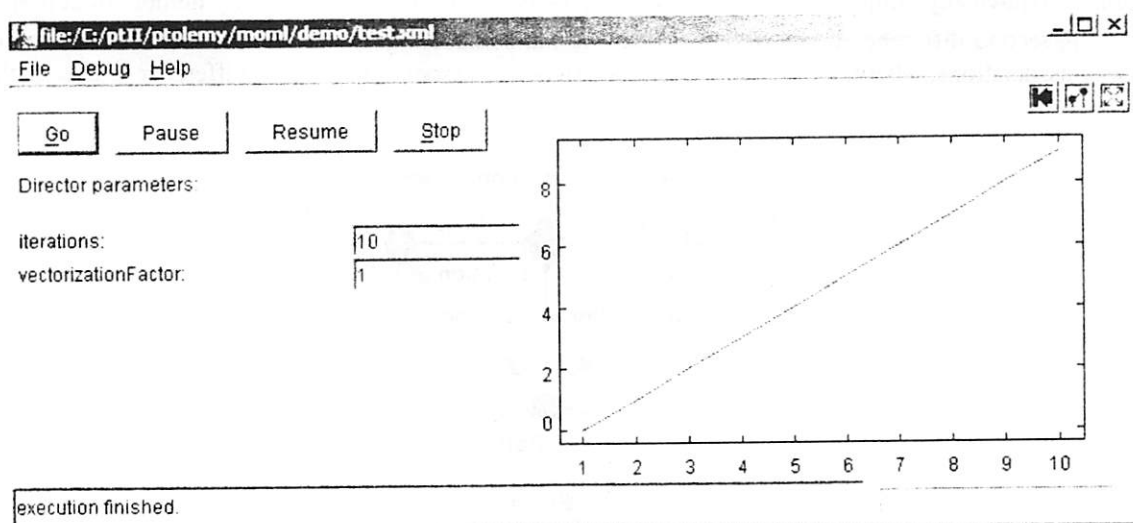

FIGURE 5.2. Simple example of a Ptolemy II model execution control window.

- *Semantics independence.* MoML defines no semantics for an interconnection of components. It represents only the hierarchical containment relationships between entities with properties, their ports, and the connections between their ports. In Ptolemy II, the meaning of a connection (the semantics of the model) is defined by the director for the model, which is a property of the top-level entity. The director defines the semantics of the interconnection. MoML knows nothing about directors except that they are instances of classes that can be loaded by the class loader and assigned as properties.

5.2.1 Clustered Graphs

A model is given as a clustered graph, which is an *abstract syntax* for representing netlists, state transition diagrams, block diagrams, etc. An abstract syntax is a conceptual data organization. A particular clustered graph configuration is called a *topology*. A topology is a collection of *entities* and *relations*. Furthermore, entities have *ports* and relations connect the ports. We consistently use the term *connection* to denote the association between connected ports (or their entities), and the term *link* to denote the association between ports and relations. Thus, a connection consists of a relation and two or more links.

The concept of an abstract syntax can be contrasted with a *concrete syntax*, which is a persistent, readable representation of the data. For example, EDIF is a concrete syntax for representing netlists. MoML is a concrete syntax for the clustered graph abstract syntax. Furthermore, we use the visual notation shown in figure 5.3, where entities are depicted as rounded boxes, relations as diamonds, and entities as filled circles.

The use of ports and hierarchy distinguishes our topologies from mathematical graphs. In a mathematical graph, an entity would be a vertex, and an arc would be a connection between entities. A vertex could be represented in our schema using entities that always contain exactly one port. In a directed graph, the connections are divided into two subsets, one consisting of incoming arcs, and the other of outgoing arcs. The vertices in such a graph could be represented by entities that contain two ports, one for incoming arcs and one for outgoing arcs. Thus, in mathematical graphs, entities always have one or two ports, depending on whether the graph is directed. Our schema generalizes this by permitting an entity to have any number of ports, thus dividing its connections into an arbitrary number of subsets.

A second difference between our graphs and mathematical graphs is that our relations are multi-way associations, whereas an arc in a graph is a two-way association. A third difference is that mathe-

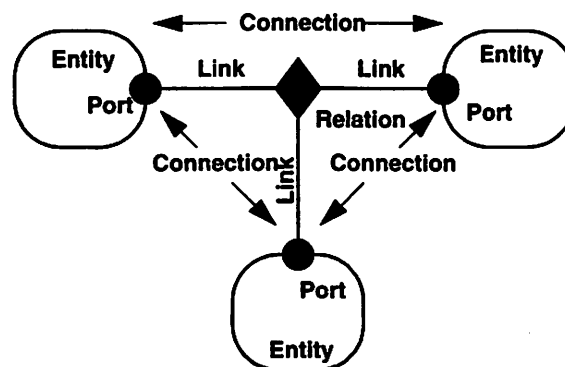

FIGURE 5.3. Visual notation and terminology.

mational graphs normally have no notion of hierarchy (clustering).

Relations are intended to serve as mediators, in the sense of the Mediator design pattern[28]. “Mediator promotes loose coupling by keeping objects from referring to each other explicitly...” For example, a relation could be used to direct messages passed between entities. Or it could denote a transition between states in a finite state machine, where the states are represented as entities. Or it could mediate rendezvous between processes represented as entities. Or it could mediate method calls between loosely associated objects, as for example in remote method invocation over a network.

5.2.2 Abstraction

Composite entities (clusters) are entities that can contain a topology (entities and relations). Clustering is illustrated by the example in figure 5.4. A port contained by a composite entity has inside as well as outside links. Such a port serves to expose ports in the contained entities as ports of the composite. This is the converse of the “hiding” operator often found in process algebras. Ports within an entity are hidden by default, and must be explicitly exposed to be visible (linkable) from outside the entity³. The composite entity with ports thus provides an abstraction of the contents of the composite.

5.3 Specification of a Model

In this section, we describe the XML elements that are used to define MoML models.

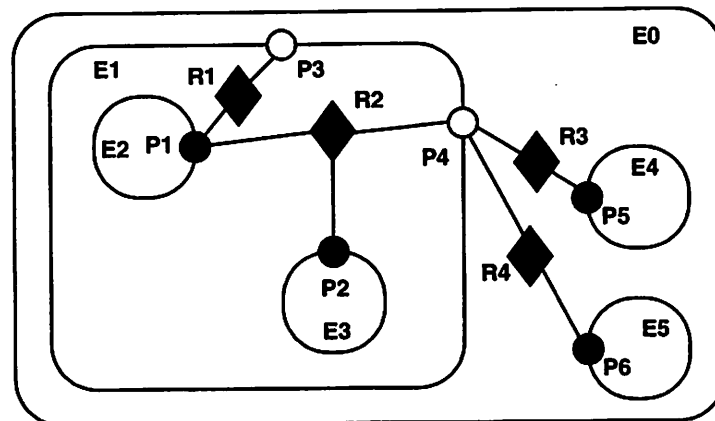

FIGURE 5.4. Ports (P3 and P4) are linked to relations (R1 and R2) below their container (E1) in the hierarchy. They may also be linked to relations at the same level (R3 and R4).

3. Unless level-crossing links are allowed. MoML supports these, but they are discouraged.

5.3.1 Data Organization

As with all XML files, MoML files have two parts, one defining the MoML language and one containing the model data. The first part is called the *document type definition*, or DTD. This dual specification of content and structure is a key XML innovation. The DTD for MoML is given in figure 5.5. If you are adept at reading these, it is a complete specification of the schema. However, since it is not particularly easy to read, we explain its key features here.

Every MoML file must either contain or refer to a DTD. The simplest way to do this is with the following file structure:

```
<?xml version="1.0" standalone="no"?>
<!DOCTYPE entity PUBLIC "-//UC Berkeley//DTD MoML 1//EN"
    "http://ptolemy.eecs.berkeley.edu/xml/dtd/MoML_1.dtd">
<entity name="modelname" class="classname">
    model definition ...
</entity>
```

Here, “*model definition*” is a set of XML elements that specify a clustered graph. The syntax for these elements is described in subsequent sections. The first line above is required in any XML file. It asserts the version of XML that this file is based on (1.0) and states that the file includes external references (in this case, to the DTD). The second and third lines declare the document type (model) and provide references to the DTD.

The references to the DTD above refer to a “public” DTD. The name of the DTD is

```
-//UC Berkeley//DTD MoML 1//EN
```

which follows the standard naming convention of public DTDs. The leading dash “-” indicates that this is not a DTD approved by any standards body. The first field, surrounded by double slashes, is the name of the “owner” of the DTD, “UC Berkeley.” The next field is the name of the DTD, “DTD MoML 1” where the “1” indicates version 1 of the MoML DTD. The final field, “EN” indicates that the language assumed by the DTD is English. The Ptolemy II MoML parser requires that the public DTD be given exactly as shown, or it will not recognize the file as MoML.

In addition to the name of the DTD, the DOCTYPE element includes a URL pointing to a copy of the DTD on the web. If a particular MoML tool does not have access to a local copy of the DTD, then it finds it at this web site.

The “entity” element may be replaced by a “class” element, as in:

```
<?xml version="1.0" standalone="no"?>
<!DOCTYPE class PUBLIC "-//UC Berkeley//DTD MoML 1//EN"
    "http://ptolemy.eecs.berkeley.edu/xml/dtd/MoML_1.dtd">
<class name="modelname" class="classname">
    class definition ...
</class>
```

We will say more about class definitions below.

```

<!ELEMENT class (class | configure | deleteEntity | deletePort | deleteRelation | director |
doc | entity | group | import | input | link | port | property | relation | rename |
rendition | unlink)*>
<!ATTLIST class name CDATA #REQUIRED
extends CDATA #IMPLIED
source CDATA #IMPLIED>

<!ELEMENT configure (#PCDATA)>
<!ATTLIST configure source CDATA #IMPLIED>

<!ELEMENT deleteEntity EMPTY>
<!ATTLIST deleteEntity name CDATA #REQUIRED>

<!ELEMENT deletePort EMPTY>
<!ATTLIST deletePort name CDATA #REQUIRED>

<!ELEMENT deleteProperty EMPTY>
<!ATTLIST deleteProperty name CDATA #REQUIRED>

<!ELEMENT deleteRelation EMPTY>
<!ATTLIST deleteRelation name CDATA #REQUIRED>

<!ELEMENT doc (#PCDATA)>
<!ATTLIST doc name CDATA #IMPLIED>

<!ELEMENT entity (class | configure | deleteEntity | deletePort | deleteRelation | director |
doc | entity | group | import | input | link | port | property | relation | rename |
rendition | unlink)*>
<!ATTLIST entity name CDATA #REQUIRED
class CDATA #IMPLIED
source CDATA #IMPLIED>

<!ELEMENT group ANY>
<!ATTLIST group name CDATA #IMPLIED>

<!ELEMENT input EMPTY>
<!ATTLIST input source CDATA #REQUIRED>

<!ELEMENT link EMPTY>
<!ATTLIST link insertAt CDATA #IMPLIED
port CDATA #REQUIRED
relation CDATA #REQUIRED
vertex CDATA #IMPLIED>

<!ELEMENT port (configure | doc | property | rename)*>
<!ATTLIST port class CDATA #IMPLIED
name CDATA #REQUIRED>

<!ELEMENT property (configure | doc | property | rename)*>
<!ATTLIST property class CDATA #IMPLIED
name CDATA #REQUIRED
value CDATA #IMPLIED>

<!ELEMENT relation (configure | doc | property | rename | vertex)*>
<!ATTLIST relation name CDATA #REQUIRED
class CDATA #IMPLIED>

<!ELEMENT rename EMPTY>
<!ATTLIST rename name CDATA #REQUIRED>

<!ELEMENT unlink EMPTY>
<!ATTLIST unlink index CDATA #IMPLIED
insideIndex CDATA #IMPLIED
insideIndex CDATA #IMPLIED
port CDATA #REQUIRED
relation CDATA #REQUIRED>

<!ELEMENT vertex (configure | doc | location | property | rename)*>
<!ATTLIST vertex name CDATA #REQUIRED
pathTo CDATA #IMPLIED
value CDATA #IMPLIED>

```

FIGURE 5.5. MoML version 1.2 DTD.

5.3.2 Overview of XML

An XML document consists of the header tags “<?xml ... ?>” and “<!DOCTYPE ... >” followed by exactly one *element*. The element has the structure:

```
start tag
body
end tag
```

where the start tag has the form

```
<elementName attributes>
```

and the end tag has the form

```
</elementName>
```

The body, if present, can contain additional elements as well as arbitrary text. If the body is not present, then the element is said to be *empty*; it can optionally be written using the shorthand:

```
<elementName attributes/>
```

where the body and end tag are omitted.

The attributes are given as follows:

```
<elementName attributeName="attributeValue" .../>
```

Which attributes are legal in an element is defined by the DTD. The quotation marks delimit the value of the attributes, so if the attribute value needs to contain quotation marks, then they must be given using the special XML entity “",” as in the following example:

```
<elementName attributeName="&quot;foo&quot;"/>
```

The value of the attribute will be

```
"foo"
```

(with the quotation marks).

In XML “",” is called an *entity*, creating possible confusion with our use of entity in Ptolemy II. In XML, an entity is a named storage unit of data. Thus, “",” references an entity called “quot” that stores a double quote character.

5.3.3 Names and Classes

Most MoML elements have *name* and *class* attributes. The name is a handle for the object being defined or referenced by the element. In MoML, the same syntax is used to reference a pre-existing object as to create a new object. If a new object is being created, then the class attribute (usually) must

be given. If a pre-existing object is being referenced, or if the MoML reader has a built-in default class for the element, then the class attribute is optional. If the class attribute is given, then the pre-existing object must be an instance of the specified class.

A name is either absolute or relative. Absolute names begin with a period "." and consist of a series of name fields separated by periods, as in ".x.y.z". Each name field can have alphanumeric characters, spaces, or the underscore "_" character. The first field is the name of the top-level model or class object. The second field is the name of an object immediately contained by that top-level.

Any name that does not begin with a period is relative to the current context, the object defined or referenced by an enclosing element. The first field of such a name refers to or defines an object immediately contained by that object. For example, inside of an object with absolute name ".x" the name "y.z" refers to an object with absolute name ".x.y.z".

A name is required to be unique within its container. That is, in any given model, the absolute names of all the objects must be unique. There can be two objects named "z", but they must not be both contained by ".x.y".

Not much more will be said about classes. Particular implementations of MoML can use this field as necessary to specify different variations of the basic syntactic objects. The class names that are used in the Ptolemy II implementation of MoML are always fully qualified Java class names. In addition, in Ptolemy II a MoML file can be referenced as a class in the same way

5.3.4 Model Element

A very simple MoML file looks like this:

```
<?xml version="1.0" standalone="no"?>
<!DOCTYPE entity PUBLIC "-//UC Berkeley//DTD MoML 1//EN"
    "http://ptolemy.eecs.berkeley.edu/xml/dtd/moml.dtd">
<entity name="modelName" class="classname">
</entity>
```

A *model* element has name and class attributes. This value of the class attribute must be a class that instantiable by the MoML tool. For example, in Ptolemy II, we can define a model with:

```
<?xml version="1.0" standalone="no"?>
<!DOCTYPE entity PUBLIC "-//UC Berkeley//DTD MoML 1//EN"
    "http://ptolemy.eecs.berkeley.edu/xml/dtd/moml.dtd">
<entity name="ptIImodel" class="ptolemy.actor.TypedCompositeActor">
</entity>
```

Here, `ptolemy.actor.TypedCompositeActor` is a class that a Java class loader can find and that the MoML parser can instantiate. In Ptolemy II, it is a container class for clustered graphs representing executable models or libraries of instantiable model classes. A model can be an instance of `ptolemy.kernel.util.NamedObj` or any derived class, although most useful models will be instances of `ptolemy.kernel.CompositeEntity` or a derived class. `TypedCompositeActor`, as in the above example, is derived from `CompositeEntity`.

5.3.5 Entity Element

A model typically contains entities, as in the following Ptolemy II example:

```

<?xml version="1.0" standalone="no"?>
<!DOCTYPE entity PUBLIC "-//UC Berkeley//DTD MoML 1//EN"
    "http://ptolemy.eecs.berkeley.edu/xml/dtd/moml.dtd">
<entity name="ptIImodel" class="ptolemy.actor.TypedCompositeActor">
  <entity name="source" class="ptolemy.actor.lib.Ramp"/>
  <entity name="sink" class="ptolemy.actor.lib.SequencePlotter"/>
</entity>

```

Notice the common XML shorthand here of writing “<entity ... />” rather than “<entity ...></entity>.” Of course, the shorthand only works if there is nothing in the body of the entity element.

An entity can contain other entities, as shown in this example:

```

<entity name="ptIImodel" class="ptolemy.actor.TypedCompositeActor">
  <entity name="container" class="ptolemy.actor.TypedCompositeActor">
    <entity name="source" class="ptolemy.actor.lib.Ramp"/>
  </entity>
</entity>

```

An entity must specify a class unless the entity already exists in the containing entity or model. The name of the entity reflects the container hierarchy. Thus, in the above example, the *source* entity has the full name “.ptIImodel.container.source”.

The definition of an entity can be distributed in the MoML file. Once created, it can be referred to again by name as follows:

```

<entity name="top" class="classname">
  <entity name="x" class="classname"/>
  ...
  <entity name="x">
    <property name="y">
  </entity>
</entity>

```

The property element (see section 5.3.6 below) is added to the pre-existing entity with name “x” when the second entity element is encountered.

In principle, MoML supports multiple containment, as in the following:

```

<entity name="top" class="classname">
  <entity name="x" class="classname"/>
  ...
  <entity name="y" class="classname">
    <entity name=".top.x"/>
  </entity>
</entity>

```

Here, the element named “x” appears both in “top” and in “.top.y”, i.e. the same instance appears in two different places. Thus, it would have two full names, “.top.x” and “.top.y.x”. However, Ptolemy II

does not support this, as it implements a strict container relationship, where an object can have only one container. Thus, attempting to parse the above MoML will result in an exception being thrown.

5.3.6 Properties

Entities (and some other elements) can be parameterized. There are two mechanisms. The simplest one is to use the *property* element:

```
<entity name="source" class="ptolemy.actor.lib.Ramp">
  <property name="init"
    value="5"
    class="ptolemy.data.expr.Parameter"/>
</entity>
```

The property element has a name, at minimum (the value and class are optional). It is common for the enclosing class to already contain properties, in which case the property element is used only to set the value. For example:

```
<entity name="source" class="ptolemy.actor.lib.Ramp">
  <property name="init" value="5"/>
</entity>
```

In the above, the enclosing object (*source*, an instance of `ptolemy.actor.lib.Ramp`) must already contain a property with the name *init*. This is typically how library components are parameterized. In Ptolemy II, the value of a property may be an expression, as in “PI/50”. The expression may refer to other properties of the containing entity or of its container. Note that the expression language is not part of MoML, but is rather part of Ptolemy II. In MoML, a property value is simply an uninterpreted string. It is up to a MoML tool, such as Ptolemy II, to interpret that string.

A property can be declared without a class and without a pre-existing property if it is a *pure property*, one with only a name and no value. For example:

```
<entity name="source" class="ptolemy.actor.lib.Ramp">
  <property name="abc"/>
</entity>
```

A property can also contain a property, as in

```
<property name="x" value="5">
  <property name="y" value="10"/>
</property>
```

A second, much more flexible mechanism is provided for parameterizing entities. The *configure* element can be used to specify a relative or absolute URL pointing to a file that configures the entity, or it can be used to include the configuration information in line. That information need not be MoML information. It need not even be XML, and can even be binary encoded data (although binary data cannot be in line; it must be in an external file). For example,

```
<entity name="sink" class="ptolemy.actor.lib.SequencePlotter">
  <configure source="url"/>
```

```
</entity>
```

Here, *url* can give the name of a file containing data, or a URL for a remote file. (For the Sequence-Plotter actor, that external data will have PlotML syntax; PlotML is another XML schema for configuring plotters.) Configure information can also be given in the body of the MoML file as follows:

```
<entity name="sink" class="ptolemy.actor.lib.SequencePlotter">
  <configure>
    configure information
  </configure>
</entity>
```

With the above syntax, the configure information must be textual data. It can contain XML markup with only one restriction: if the tag “</configure>” appears in the textual data, then it must be preceded by a matching “<configure>”. That is, any configure elements in the markup must have balanced start and end tags.⁴

You can give both a source attribute and in-line configuration information, as in the following:

```
<entity name="sink" class="ptolemy.actor.lib.SequencePlotter">
  <configure source="url">
    configure information
  </configure>
</entity>
```

In this case, the file data will be passed to the application first, followed by the in-line configuration data.

In Ptolemy II, the configure element is supported by any class that implements the Configurable interface. That interface defines a configure() method that accepts an input stream. Both external file data and in-line data are provided to the class as a character stream by calling this method.

There is a subtle limitation with using markup within the configure element. If any of the elements within the configure element match MoML elements, then the MoML DTD will be applied to assign default values, if any, to their attributes. Thus, this mechanism works best if the markup within the configure element is not using an XML schema that happens to have element names that match those in MoML. Alternatively, if it does use MoML element names, then those elements are used with their MoML meaning. This limitation can be fixed using XML namespaces, something we will eventually implement.

5.3.7 Doc Element

Some elements can be documented using the *doc* element. For example,

```
<entity name="source" class="ptolemy.actor.lib.Ramp">
  <property name="init" value="5">
```

4. XML allow markup to be included in arbitrary data as long as it appears within either a processing instruction or a CDATA body. However, for reasons that would only baffle anyone familiar with modern programming languages, processing instructions and CDATA bodies cannot be nested within one another. The MoML configure element can be nested, so it offers a much more flexible mechanism than the standard ones in XML.

```

    <doc>Initialize the ramp above the default because... </doc>
  </property>
  <doc>
    This actor produces an increasing sequence beginning with 5.
  </doc>
</entity>

```

With the above syntax, the documentation information must be textual data. It can include markup, as in the following example, which uses XHTML⁵ formatting within the doc element:

```

<entity name="source" class="ptolemy.actor.lib.Ramp">
  <doc><H1>Using HTML</H1>Text with <I>markup</I>.</doc>
</entity>

```

An alternative method is to use an XML processing instruction as follows:

```

<entity name="source" class="ptolemy.actor.lib.Ramp">
  <doc><?xhtml <H1>Using HTML</H1>Text with <I>markup</I>.<?></doc>
</entity>

```

This requires that any utility that uses the documentation information be able to handle the `xhtml` processing instruction, but it makes it very clear that the contents are XHTML. However, for reasons we do not understand, XML does not allow processing instructions to be nested, so this technique has its limitations.

More than one doc element can be included in an element. To do this, give each doc element a name, as follows:

```

<entity name="entityname" class="classname">
  <doc name="docname">
    doc contents
  </doc>
</entity>

```

The name must not conflict with any preexisting property. If a doc element or a property with the specified name exists, then it is removed and replaced with the property. If no name is given, then the doc element is assigned the name “_doc”.

A common convention, used in Ptolemy II, is to add doc elements with the name “tooltip” to define a tooltip for GUI views of the component. A tooltip is a small window with short documentation that pops up when the mouse lingers on the graphical component.

Note that the same limitation of using markup within configure elements also applies to doc elements.

5. XHTML is HTML with additional constraints so that it conforms with XML syntax rules. In particular, every start tag must be matched by an end tag, something that ordinary HTML does not require (but fortunately, does allow).

5.3.8 Ports

An entity can declare a port:

```
<entity name="A" class="classname">
  <port name="out"/>
</entity>
```

In the above example, no class is given for the port. If a port with the specified name already exists in the class for entity A, then that port is the one referenced. Otherwise, a new port is created in Ptolemy II by calling the `newPort()` method of the container. Alternatively, we can specify a class name, as in

```
<entity name="A" class="classname">
  <port name="out" class="classname"/>
</entity>
```

In this case, a port will be created if one does not already exist. If it does already exist, then its class is checked for consistency with the declared class (the pre-existing port must be an instance of the declared class). In Ptolemy II, the typical classname for a port would be

```
ptolemy.actor.TypedIOPort
```

In Ptolemy II, the container of a port is required to be an instance of `ptolemy.kernel.Entity` or a derived class.

It is often useful to declare a port to be an input, an output, or both. To do this, enclose in the port a property named "input" or "output" or both, as in the following example:

```
<port name="out" class="ptolemy.actor.IOPort">
  <property name="output"/>
</port>
```

This is an example of a pure property. Optionally, the property can be given a boolean value, as in

```
<port name="out" class="ptolemy.actor.IOPort">
  <property name="output" value="true"/>
</port>
```

The value can be either "true" or "false", where the latter will define the port to not be an output. A port can be defined to be both an input and an output, as follows

```
<port name="out" class="ptolemy.actor.IOPort">
  <property name="output" value="true"/>
  <property name="input" value="true"/>
</port>
```

It is also sometimes necessary to declare that a port is a multiport. To do this, enclose in the port a property named "multiport" as in the following example:

```
<port name="out" class="ptolemy.actor.IOPort">
  <property name="multiport"/>
</port>
```

The enclosing port must be an instance of IOPort (or a derived class such as TypedIOPort), or else the property is treated as an ordinary property. As with the input and output attribute, the multiport property can be given a boolean value, as in

```
<port name="out" class="ptolemy.actor.IOPort">
  <property name="multiport" value="true"/>
</port>
```

If a port is an instance of TypedIOPort (for library actors, most are), then you can set the type of the port in MoML as follows:

```
<port name="out" class="ptolemy.actor.IOPort">
  <property name="type"
    value="double"
    class="ptolemy.actor.TypeAttribute"/>
</port>
```

This is occasionally useful when you need to constrain the types beyond what the built-in type system takes care of. The names of the built-in types are (currently) boolean, booleanMatrix, complex, complexMatrix, double, doubleMatrix, fix, fixMatrix, int, intMatrix, long, longMatrix, object, string, and general. These are defined in the class `ptolemy.data.type.BaseType`.

5.3.9 Relations and Links

To connect entities, you create relations and links. The following example describes the topology shown in figure 5.6:

```
<entity name="top" class="classname">
```

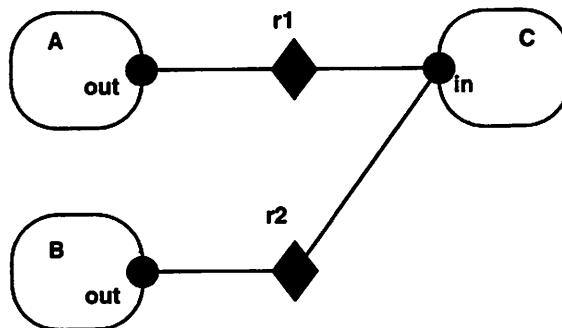

FIGURE 5.6. Example topology.

```

<entity name="A" class="classname">
  <port name="out"/>
</entity>
<entity name="B" class="classname">
  <port name="out"/>
</entity>
<entity name="C" class="classname">
  <port name="in">
    <property name="multiport"/>
  </port>
</entity>
<relation name="r1" class="classname"/>
<relation name="r2" class="classname"/>
<link port="A.out" relation="r1"/>
<link port="B.out" relation="r2"/>
<link port="C.in" relation="r1"/>
<link port="C.in" relation="r2"/>
</entity>

```

In Ptolemy II, the typical classname for a relation would be `ptolemy.actor.TypedIORelation`. The classname may be omitted, in which case the `newRelation()` method of the container is used to create a new relation. The container is required to be an instance of `ptolemy.kernel.CompositeEntity`, or a derived class. As usual, the class attribute may be omitted if the relation already exists in the containing entity.

Notice that this example has two distinct links to `C.in` from two different relations. The order of these links may be important to a MoML tool, so any MoML tool must preserve the order in which they are specified, as Ptolemy II does. We say that `C` has two links, indexed 0 and 1.

The `link` element can explicitly give the index number at which to insert the link. For example, we could have achieved the same effect above by saying

```

<link port="C.in" relation="r1" insertAt="0"/>
<link port="C.in" relation="r2" insertAt="1"/>

```

Whenever the `insertAt` option is not specified, the link is always appended to the end of the list of links.

When the `insertAt` option is specified, the link is inserted at that position, so any pre-existing links with larger indices will have their index numbers incremented. For example, if we do

```

<link port="C.in" relation="r1" insertAt="0"/>
<link port="C.in" relation="r2" insertAt="1"/>
<link port="C.in" relation="r3" insertAt="1"/>

```

then there will be a link to `r1` with index 0, a link to `r2` with index 2 (note! not 1), and a link to `r3` with index 1.

If the specified index is beyond the existing number of links, then null links (i.e. links to nothing) are created to fill in. So for example, if the first link we create is given by

```

<link port="C.in" relation="r2" insertAt="1"/>

```

then the port will have *two* links, not one, but the first one will be an empty link. If we then say

```
<link port="C.in" relation="r2"/>
```

then the port will have *three* links, with the first one being empty. If we then say

```
<link port="C.in" relation="r2" insertAt="0"/>
```

then there will be *four* links, with the *second* one being empty.

Note that the index number is not the same thing as the channel number in Ptolemy II. In Ptolemy II, a relation may have a width greater than one, so a single link may represent more than one channel (actually, it could even represent zero channels if that relation is not linked to another ports).

5.3.10 Classes

So far, entities have been instances of externally defined classes accessed via a class loader. They can also be instances of classes defined in MoML. To define a class in MoML, use the *class* element, as in the following example:⁶

```
<?xml version="1.0" standalone="no"?>
<!DOCTYPE class PUBLIC "-//UC Berkeley//DTD MoML 1//EN"
  "http://ptolemy.eecs.berkeley.edu/xml/dtd/moml.dtd">
<class name="Gen" extends="ptolemy.actor.TypedCompositeActor">
  <entity name="ramp" class="ptolemy.actor.lib.Ramp">
    <port name="output"/>
    <property name="step" value="2*PI/50"/>
  </entity>
  <entity name="sine" class="ptolemy.actor.lib.TrigFunction">
    <port name="input"/>
    <port name="output"/>
  </entity>
  <port name="output" class="ptolemy.actor.TypedIOPort"/>
  <relation name="r1" class="ptolemy.actor.TypedIORelation"/>
  <relation name="r2" class="ptolemy.actor.TypedIORelation"/>
  <link port="ramp.output" relation="r1"/>
  <link port="sine.input" relation="r1"/>
  <link port="sine.output" relation="r2"/>
  <link port="output" relation="r2"/>
</class>
```

The class element may be the top-level element in a file, in which case the DOCTYPE should be declared as "class" as done above. It can also be nested within a model. The above example specifies the topology shown in figure 5.7. Once defined, it can be instantiated as if it were a class loaded by the class loader:

6. This is a simplified version of the Sinewave class, whose complete definition is given in the appendix.

```
<entity name="instancename" class="classname"/>
```

or

```
<entity name="instancename" class="classname" source="url"/>
```

The first form can be used if the class definition can be found from the *classname*. There are two ways that this could happen. First, the *classname* might be an absolute name for a class defined within the same top level entity that this entity element is in. Second, the *classname* might be sufficient to find the class definition in a file, much the way Java classes are found. For example, if the classname is `ptolemy.actor.lib.Sinewave` and the class is defined in the file `$PTII/ptolemy/actor/lib/Sinewave.xml`, then there is no need to use the second form to specify the URL where the class is defined. Specifically, the CLASSPATH⁷ is searched for a file matching the classname. By convention, the file defining the class has the same name as the class, with the extension “.xml” or “.moml”.

In the first of these techniques, the class name follows the same convention as entity names, except that a classname referring to a class defined within the same MoML top-level must be absolute. In fact, a class *is* an entity with the additional feature that one can create new instances of it with the entity element. Consider for example,

```
<?xml version="1.0" standalone="no"?>
<!DOCTYPE entity PUBLIC "-//UC Berkeley//DTD MoML 1//EN"
  "http://ptolemy.eecs.berkeley.edu/xml/dtd/moml.dtd">
<entity name="top" extends="ptolemy.kernel.CompositeEntity">
  <class name="Gen" extends="ptolemy.actor.TypedCompositeActor">
    class definition ...
  </class>
  <entity name="derived" class=".top.Gen"/>
</entity>
```

Here, the entity `derived` is an instance of `.top.Gen`, which is defined within the same MoML top level. The absolute class name is “.top.Gen”.

The ability to give a URL as the source of a class definition is very powerful. It means that a model may be build from component libraries that are defined worldwide. There is no need to localize these.

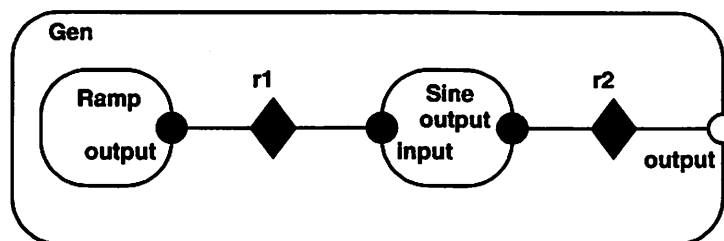

FIGURE 5.7. Sine wave generator topology.

7. CLASSPATH is an environment variable that Java uses to find Java classes. The Ptolemy II implementation of MoML simply leverages this so that MoML classes can also be found if they are on the CLASSPATH.

Of course, referencing a URL means the usual risks that the link will become invalid. It is our hope that reliable and trusted sources of components will emerge who will not allow this to happen.

The Gen class given at the beginning of this subsection generates a sine wave with a period of 50 samples. It is not all that useful without being parameterized. Let us extend it and add properties:⁸

```
<class name="Sinegen" extends="Gen">
  <property name="samplingFrequency"
    value="8000.0"
    class="ptolemy.data.expr.Parameter">
    <doc>The sampling frequency in Hertz.</doc>
  </property>
  <property name="frequency"
    value="440.0"
    class="ptolemy.data.expr.Parameter">
    <doc>The frequency in Hertz.</doc>
  </property>
  <property name="ramp.step"
    value="frequency*2*PI/samplingFrequency">
    <doc>Formula for the step size.</doc>
  </property>
  <property name="ramp.init"
    value="phase">
  </property>
</class>
```

This class extends Gen by adding two properties, and then sets the properties of the component entities to have values that are expressions.

5.3.11 Inheritance

MoML supports inheritance by permitting you to extend existing classes. For example, consider the following MoML file:

```
<?xml version="1.0" standalone="no"?>
<!DOCTYPE entity PUBLIC "-//UC Berkeley//DTD MoML 1//EN"
  "http://ptolemy.eecs.berkeley.edu/xml/dtd/moml.dtd">
<entity name="top" class="ptolemy.kernel.CompositeEntity">
  <class name="base" extends="ptolemy.kernel.CompositeEntity">
    <entity name="e1" class="ptolemy.kernel.ComponentEntity">
    </entity>
  </class>
  <class name="derived" extends=".top.base">
    <entity name="e2" class="ptolemy.kernel.ComponentEntity"/>
  </class>
  <entity name="instance" extends=".top.derived"/>
</entity>
```

8. This is still not quite as elaborate as the Sinewave class defined in the appendix, which is why we give it a slightly different name, Sinegen.

Here, the “derived” class extends the “base” class by adding another entity to it, and “instance” is an instance of derived. The class “derived” can also give a source attribute, which gives a URL for the source definition.

5.3.12 Directors

Recall that a clustered graph in MoML has no semantics. However, a particular model has semantics. It may be a dataflow graph, a state machine, a process network, or something else. To give it semantics, Ptolemy II requires the specification of a director associated with a model, an entity, or a class. The director is a property of the model. The following example gives discrete-event semantics to a Ptolemy II model:

```
<entity name="top" class="ptolemy.actor.TypedCompositeActor">
  <property name="director"
    class="ptolemy.domains.de.kernel.DEDirector">
    <property name="stopTime" value="100.0"/>
  </director>
  ...
</entity>
```

This example also sets a property of the director. The name of the director is not important, except that it cannot collide with the name of any other property in the model.

5.3.13 Input Element

It is possible to insert MoML from another file or URL into a particular point in your model. For example:

```
<entity name="top" class="...">
  <entity name="a" class="...">
    <input source="url"/>
  </entity>
</entity>
```

This takes the contents of the URL specified in the source attribute of the input element and places them inside the entity named “a”. The base of the current document (the one containing the import statement) is used to interpret a relative URL, or if the current document has no base, then the current working directory is used, or if that fails, the current CLASSPATH.

5.3.14 Annotations for Visual Rendering

The abstract syntax of MoML, clustered graphs, is amenable to visual renditions as bubble and arc diagrams or as block diagrams. To support tools that display and/or edit MoML files visually, MoML allows a relation to have multiple vertices that form a path. Links can then be made to individual vertices. Consider the following example:

```
<relation name="r" class="ptolemy.actor.TypedIORelation">
  <vertex name="v1" class="classname" value="location"/>
  <vertex name="v2" class="classname" value="location" pathTo="v1"/>
```

```

</relation>
<link port="A.out" relation="r" vertex="v1"/>
<link port="B.in" relation="r" vertex="v1"/>
<link port="C.in" relation="r" vertex="v2"/>

```

This assumes that there are three entities named *A*, *B*, and *C*. The relation is annotated with a set of vertices, *v1* and *v2*, which will normally be rendered as graphical objects. The vertices are linked together with paths, which in a simple visual tool might be straight lines, or in a more sophisticated tool might be autorouted paths. In the above example, *v1* and *v2* are linked by a path. The link elements specify not just a relation, but also a vertex within that relation. This tells the visual rendering tool to draw a path from the specified port to the specified vertex.

Figure 5.8 illustrates how the above fragment might be rendered. The square boxes are icons for the three entities. They have ports with arrowheads suggesting direction. There is a single relation, which shows up visually only as a set of lines and two vertices. The vertices are shown as small diamonds.

A vertex is exactly like a property, except that it has an additional attribute, *pathTo*, used to link vertices, and it can be referenced in a link element. Like any other property, it has a class attribute, which specifies the class implementing the vertex. In Ptolemy II, the class for a vertex is typically `ptolemy.moml.Vertex`. Like other properties, a vertex can have a value. This value will typically specify a location for a visual rendition. For example, in Ptolemy II, the first vertex above might be given as

```

<vertex name="v1"
  class="ptolemy.moml.Vertex"
  value="184.0, 93.0"/>

```

This indicates that the vertex should be rendered at the location 184.0, 93.0.

Ptolemy II uses ordinary MoML properties to specify other visual aspects of a model. First, an entity can contain a location property, which is a hint to a visual renderer, as follows:

```

<entity name="ramp" class="ptolemy.actor.lib.Ramp">
  <property name="location"
    class="ptolemy.moml.Location"
    value="50.0, 50.0"/>
</entity>

```

This suggests to the visual renderer that the Ramp actor should be drawn at location 50.0, 50.0.

Ptolemy II also supports a powerful and extensible mechanism for specifying the visual rendition

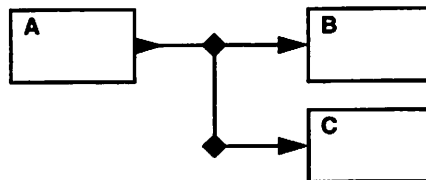

FIGURE 5.8. Example showing how MoML might be visually rendered.

of an entity. Consider the following example:

```
<entity name="ramp" class="ptolemy.actor.lib.Ramp">
  <property name="location"
    class="ptolemy.moml.Location"
    value="50.0, 50.0"/>
  <property name="iconDescription"
    class="ptolemy.kernel.util.SingletonAttribute">
    <configure><svg>
      <rect x="0" y="0" width="80" height="20"
        style="fill:green;stroke:black;stroke-width:5"/>
    </svg></configure>
  </property>
</entity>
```

The SingletonAttribute class is used to attach an XML description of the rendition, which in this case is a wide box filled with green. The XML schema used to define the icon is SVG (scalable vector graphics), which can be found at <http://www.w3.org/TR/SVG/>.⁹

The rendering of the icon is done by another property of class XMLIcon, which need not be explicitly specified because the visual renderer will create it if it isn't present. However, it is possible to create totally customized renditions by defining classes derived from XMLIcon, and attaching them to entities as properties. This is beyond the scope of this chapter.

5.4 Incremental Parsing

MoML may be used as a command language to modify existing models, as well as being used to specify complete models. This technique is known as *incremental parsing*.

5.4.1 Adding Entities

Consider for example the simple model created as follows:

```
<?xml version="1.0" standalone="no"?>
<!DOCTYPE entity PUBLIC "-//UC Berkeley//DTD MoML 1//EN"
  "http://ptolemy.eecs.berkeley.edu/xml/dtd/moml.dtd">
<entity name="top" class="ptolemy.actor.TypedCompositeActor">
  ... contents of the model ...
</entity>
```

Later, the following MoML element can be used to add an entity to the model:

```
<entity name=".top">
  <entity name="inside" class="ptolemy.actor.TypedCompositeActor"/>
</entity>
```

9. Currently, the Diva graphics infrastructure, which is used by Vergil to render these icons, only supports a small subset of SVG. Eventually, we hope it will support the full specification.

The name of the outer entity “.top” is the name of the top-level model created by the first segment of MoML. (Recall that the leading period means that the name is absolute.) The line

```
<entity name=".top">
```

defines the context for evaluation of the element

```
<entity name="inside" class="ptolemy.actor.TypedCompositeActor"/>
```

Any entity constructed in a previous parsing phase can be specified as the context for evaluation of a new MoML element.

Of course, the MoML parser must have a reference to the context in order to later parse this incremental element. This is accomplished by either using the same parser, which keeps track of the top-level entity in the last model it parsed, or by calling the `setTopLevel()` or `setContext()` methods of the parser, passing as an argument the model.

5.4.2 Using Absolute Names

Above, we have used the fact that an entity element can refer to a pre-existing element by name. That name can be relative to the context in which the entity element exists, or it can be absolute. If it is absolute, then it must nonetheless be properly contained by the enclosing entity. The following example is incorrect, and will trigger an exception:

```
<entity name="top" class="ptolemy.actor.TypedCompositeActor">
  <entity name="a" class="ptolemy.actor.TypedCompositeActor"/>
  <entity name="b" class="ptolemy.actor.TypedCompositeActor">
    <entity name=".top.a"/>
  </entity>
</entity>
```

The “.top.a” cannot be specified within “b” because it is already contained within “top.”

5.4.3 Adding Ports, Relations, and Links

A port or relation can be added to an entity that has been previously constructed by the parser. For example, assuming that `.top.inside` has been constructed as before, we can add a port to it with the following MoML segment:

```
<entity name=".top.inside">
  <port name="input" class="ptolemy.actor.TypedIOPort"/>
</entity>
```

A relation and link can then be added as follows:

```
<entity name=".top">
  <relation name="r" class="ptolemy.actor.TypedIORelation"/>
  <link port="inside.input" relation="r"/>
</entity>
```

5.4.4 Changing Port Configurations

A port that is an input can be converted to an output with the following MoML segment:

```
<port name="portname">
  <property name="input" value="false"/>
  <property name="output" value="true"/>
</port>
```

A port can be made into a multiport as follows:

```
<port name="portname">
  <property name="multiport" value="true"/>
</port>
```

5.4.5 Deleting Entities, Relations, and Ports

An entity that has been previously constructed by a parser can be deleted by evaluating MoML. For example, assuming that `.top.inside` has been constructed as before, we can delete it with the following MoML segment:

```
<entity name=".top">
  <deleteEntity name="inside"/>
</entity>
```

Any links to ports of the entity will also be deleted. Similarly, relations can be deleted using the `deleteRelation` element, and ports can be deleted using the `deletePort` element.

5.4.6 Renaming Objects

A previously existing entity can be renamed using the `rename` element, as follows:

```
<entity name="entityName">
  <rename name="newName"/>
</entity>
```

The new name is required to not have any periods in it. It consists of alphanumeric characters, the underscore, and spaces.

5.4.7 Changing Documentation, Properties, and Directors

Documentation is attached to entities using the `doc` element (see section 5.3.7). A `doc` element can optionally be given a name; if no name is given, then the name is implicitly `"_doc"`. To replace a `doc` element, just give a new `doc` element with the same name. To remove a `doc` element, give a `doc` element with the same name and an empty body, as in

```
<doc name="docname"></doc>
```

or

```
<doc name="docname" />
```

Properties can have their value changed using the property element (see section 5.3.6) with a new value, for example:

```
<property name="propertyname" value="propertyvalue" />
```

A property can be deleted using the deleteProperty element

```
<deleteProperty name="propertyname" />
```

Since a director is a property, this same mechanism can be used to remove a director.

5.4.8 Removing Links

To remove individual links, use the unlink element. This element has three forms. The first is

```
<unlink port="portname" relation="relationname" />
```

This unlinks a port from the specified relation. If the port is linked more than once to the specified relation, then all links to this relation are removed. It makes no difference whether the link is an inside link or an outside link, since this can be determined from the containers of the port and the relation.

The second and third forms are

```
<unlink port="portname" index="linknumber" />  
<unlink port="portname" insideIndex="linknumber" />
```

These both remove a link by index number. The first is used for an outside link, and the second for an inside link. The valid indices range from 0 to one less than the number of links that the port has. If the port is not a multiport, then there is at most one valid index, number 0. If an invalid index is given then the element is ignored. Note that the indexes of links above that of the removed link will be decremented by one.

The unlink element can also be used to remove null links. For example, if we have created a link with

```
<link port="portname" relation="r" insertAt="1" />
```

where there was previously no link on this port, then this leaves a null link (not linked to anything) with index 0 (see section 5.3.9), and of course a link to relation *r* with index 1. The null link can be removed with

```
<unlink port="portname" insideIndex="0" />
```

which leaves the link to *r* as the sole link, having index 0.

Note that the index is not the same thing as the channel number. A relation may have a width greater than one, so a single link may represent more than one channel (actually, it could even represent zero channels if that relation is not linked to other suitable ports).

5.4.9 Grouping Elements

Occasionally, you may wish to incrementally parse a set of elements. For example, in the Ptolemy II implementation, the parser has a method for setting the context, so you could set the context to a `CompositeEntity` and then create several entities by parsing the following MoML:

```
<entity name="firstEntity" class="classname"/>
<entity name="firstEntity" class="classname"/>
<entity name="firstEntity" class="classname"/>
```

However, the XML parser will fail to parse this because it requires that there be a single top-level element. The group element is provided for this purpose:

```
<group>
  <entity name="firstEntity" class="classname"/>
  <entity name="firstEntity" class="classname"/>
  <entity name="firstEntity" class="classname"/>
</group>
```

This element is ignored by the parser, in that it does not define a new container for the enclosed entities. It simply aggregates them, leaving the context the same as it is for the group element itself.

The group element may be given a name attribute, in which case it defines a *namespace*. All named objects (such as entities) that are immediately inside the group will have their names modified by prepending them with the name of the group and a colon. For example,

```
<group name="a">
  <entity name="b" class="classname">
    <entity name="c" class="classname"/>
  </entity>
</group>
```

The entity "b" will actually be named "a:b". The entity "c" will not be affected by the group name. Its full name, however, will be "a:b.c".

5.5 Parsing MoML

MoML is intended to be a generic modeling markup language, not one that is specialized to Ptolemy II. As such, Ptolemy II may be viewed as a reference implementation of a MoML tool. In Ptolemy II, MoML is supported primarily by the `moml` package.

The `moml` package contains the classes shown in figure 5.9 (see appendix A of chapter 1 for UML syntax). The basis for the MoML parser is the parser distributed by Microstar. The `parse()` methods of the `MoMLParser` class read MoML data and construct a Ptolemy II model. They return the top-level model. The same parser can then be used to incrementally parse MoML segments to modify that

model.

The EntityLibrary class takes particular advantage of MoML. This class extends CompositeEntity, and is designed to contain a library of entities. But it is carefully designed to avoid instantiating those entities until there is some request for them. Instead, it maintains a MoML representation of the library. This allows for arbitrarily large libraries without the overhead of instantiating components in the library that might not be needed.

Incremental parsing is when a MoML parser is used to modify a pre-existing model (see section 5.4). A MoML parser that was used to create the pre-existing model can be used to modify it. If there is no such parser, then it is necessary to call the setTopLevel() method of MoMLParser to associate the parser with the pre-existing model.

Incremental parsing should (usually) be done using a change request. A change request is an active object that makes a modification to a Ptolemy model. They are queued with a composite entity con-

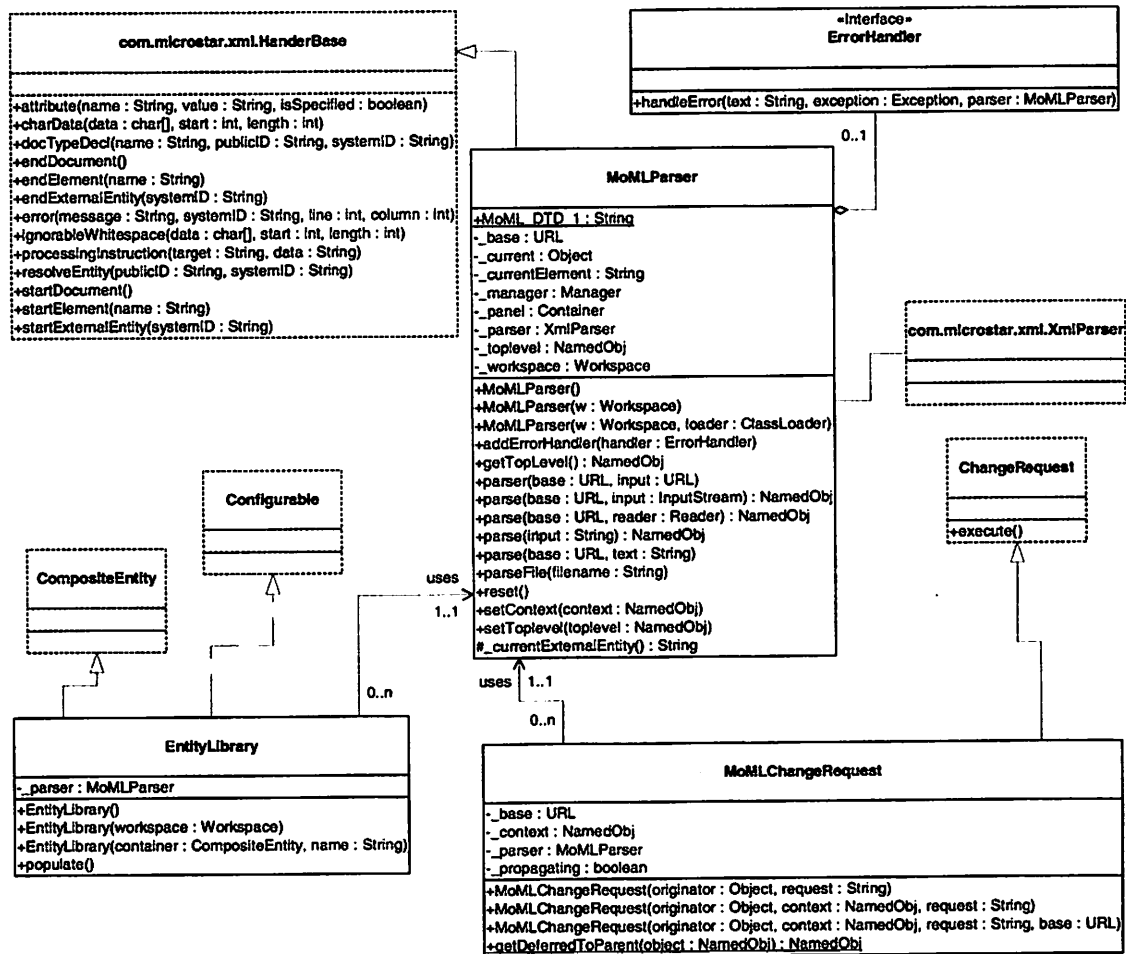

FIGURE 5.9. Classes supporting MoML parsing in the moml package.

tainer by calling its `requestChange()` method. This ensures that the mutation is executed only when it is safe to modify the structure of the model. The class `MoMLChangeRequest` (see figure 5.9) can be used for this purpose. Simply create an instance of this class, providing the constructor with a string containing the MoML code that specifies the change.

The `exportMoML()` methods of Ptolemy II objects can be used to produce a MoML file given a model. Thus, MoML can be used as the persistent file format for Ptolemy II models

5.6 Exporting MoML

Almost any Ptolemy II object can export a MoML description of itself. The following methods of `NamedObj` (and derived classes) are particularly useful:

```
exportMoML(): String
exportMoML(output: Writer)
exportMoML(output: Writer, depth: int)
exportMoML(output: Writer, depth: int, name: String)
_exportMoMLContents(output: Writer, depth: int)
```

Since any object derived from `NamedObj` can export MoML, MoML becomes an effective persistent format for Ptolemy II models. Almost everything in Ptolemy II is derived from `NamedObj`. It is much more compact than serializing the objects, and the description is much more durable (since serialized objects are not guaranteed to load properly into future versions of the Java virtual machine).

There is one significant subtlety that occurs when an entity is instantiated from a class defined in MoML. Consider the example:

```
<entity name="top" class="ptolemy.kernel.CompositeEntity">
  <class name="master" extends="ptolemy.kernel.ComponentEntity">
    <port name="p" class="ptolemy.kernel.ComponentPort"/>
  </class>
  <entity name="derived" class=".top.master"/>
</entity>
```

This model defines one class and one entity that instantiates that class. When we export MoML for this top-level model, we get:

```
<entity name="top" class="ptolemy.kernel.CompositeEntity">
  <class name="master" extends="ptolemy.kernel.ComponentEntity">
    <port name="p" class="ptolemy.kernel.ComponentPort">
      </port>
    </class>
  <entity name="derived" class=".top.master">
    </entity>
</entity>
```

Aside from some minor differences in syntax, this is identical to our specification above. In particular, note that the entity “derived” does not describe its port “p” even though it certainly has such a port. That port is implied because the entity instantiates the class “.top.master”.

Suppose that using incremental parsing we subsequently modify the model as follows:

```
<entity name=".top.derived">
  <port name="q" class="ptolemy.kernel.ComponentPort"/>
</entity>
```

That is, we add a port to the instantiated entity. Then the added port *is* exported when we export MoML. That is, we get:

```
<entity name="top" class="ptolemy.kernel.CompositeEntity">
  <class name="master" extends="ptolemy.kernel.ComponentEntity">
    <port name="p" class="ptolemy.kernel.ComponentPort">
      </port>
    </class>
  <entity name="derived" class=".top.master">
    <port name="q" class="ptolemy.kernel.ComponentPort">
      </port>
    </entity>
  </entity>
```

This is what we would expect. The entity is based on the specified class, but actually extends it with additional features. Those features are persistent.

Properties are treated more simply. They are always described when MoML is exported, regardless of whether they are defined in the class on which an entity is based. The reason for this is that properties are usually modified in instances, for example by giving them new values.

There is an additional subtlety. If a topology is modified by making direct kernel calls, then `exportMoML()` will normally export the modified topology. However, if a derived component is modified by direct kernel calls, then `exportMoML()` will fail to catch the changes. In fact, only if the changes are made by evaluating MoML will the modifications be exported. This actually can prove to be convenient. It means that if a model mutates during execution, and is later saved, that a user interface can ensure that only the original model, before mutations, is saved.

5.7 Special Attributes

The `moml` package also includes a set of attribute classes that decorate the objects in a model with MoML-specific information, as shown in figure 5.10. These classes are used to decorate a Ptolemy II object with additional information that is relevant to a GUI or other user interface. For example, the `Location` class is used to specify the location of visual rendition of a component in a visual editor. A `Vertex` decorates a relation with one of several visual handles to which connections can be made. A `MoMLAttribute` decorates an object with a property that can describe itself with arbitrary MoML.

5.8 Acknowledgements

Many thanks to Ed Willink of Racal Research Ltd. and Simon North of Synopsys for many helpful suggestions, only some of which have made it into this version of MoML. Also, thanks to Tom Henzinger, Alberto Sangiovanni-Vincentelli, and Kees Vissers for helping clarify issues of abstract syntax.

Appendix C: Example

Figures 5.11 and 5.12 show a simple Ptolemy II model in the SDF domain. Figure 5.13 shows the execution window for this model. This model generates two sinusoidal waveforms and multiplies them together. This appendix gives the complete MoML code. The MoML code is divided into two files. The first of these defined a component, a sinewave generator. The second creates two instances of this sinewave generator and multiplies their outputs. The code listings are (hopefully) self-explanatory.

C.1 Sinewave Generator

The Sinewave component is defined in the file `$PTII/ptolemy/actor/lib/Sinewave.xml`, which is listed below. This file defines a MoML class, which can then be referenced by the class name `ptolemy.actor.lib.Sinewave`. The Vergil rendition of this model is shown in figure 5.11.

```
<?xml version="1.0" standalone="no"?>
<!DOCTYPE class PUBLIC "-//UC Berkeley//DTD MoML 1//EN"
"http://ptolemy.eecs.berkeley.edu/xml/dtd/MoML_1.dtd">
<class name="Sinewave" extends="ptolemy.actor.TypedCompositeActor">
  <doc>This composite actor generates a sine wave.</doc>
  <property name="samplingFrequency" class="ptolemy.data.expr.Parameter" value="8000.0">
    <doc>The sampling frequency, in the same units as the frequency.</doc>
  </property>
  <property name="frequency" class="ptolemy.data.expr.Parameter" value="440.0">
    <doc>The frequency of the sinusoid, in the same units as the sampling frequency.</doc>
  </property>
</class>
```

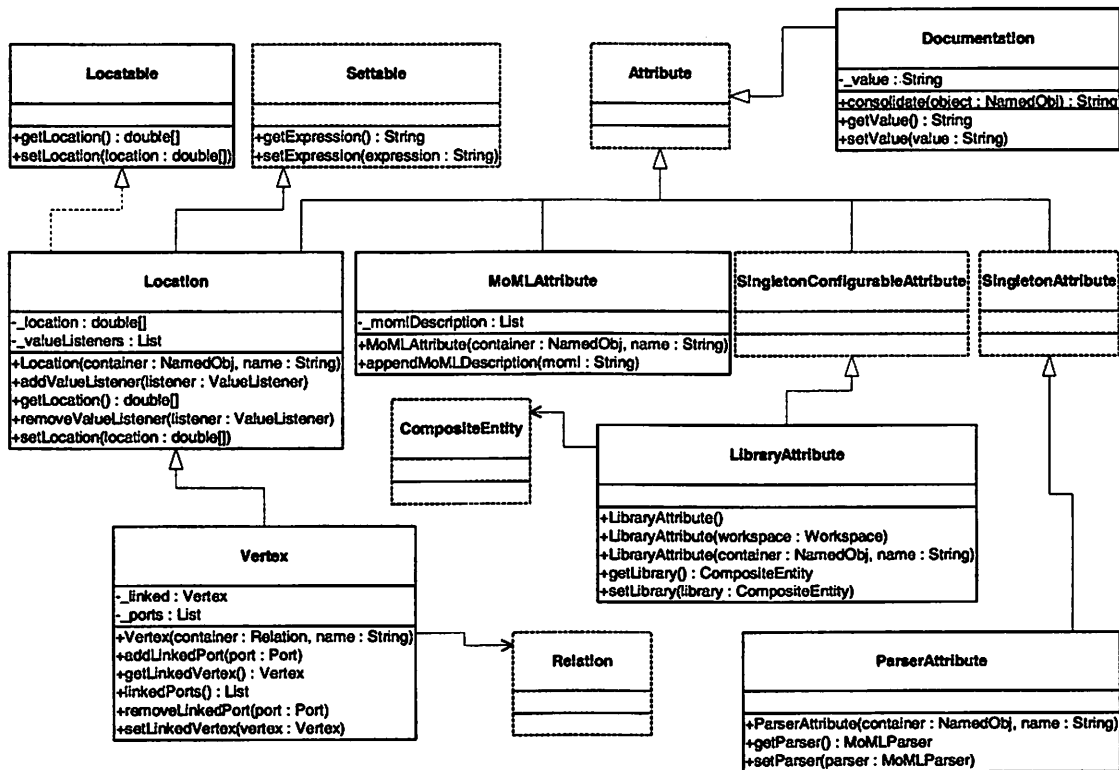

FIGURE 5.10. Attributes in the moml package.

```

</property>
<property name="phase" class="ptolemy.data.expr.Parameter" value="0.0">
  <doc>The phase, in radians.</doc>
</property>
<port name="output" class="ptolemy.actor.TypedIOPort">
  <property name="output"/>
  <doc>Sinusoidal waveform output.</doc>
  <property name="_location" class="ptolemy.moml.Location" value="460.0, 225.0">
  </property>
</port>
<entity name="Ramp" class="ptolemy.actor.lib.Ramp">
  <property name="firingCountLimit" class="ptolemy.data.expr.Parameter" value="0">
  </property>
  <property name="init" class="ptolemy.data.expr.Parameter" value="phase">
  </property>
  <property name="step" class="ptolemy.data.expr.Parameter"
    value="frequency*2*PI/samplingFrequency">
  </property>
  <property name="_location" class="ptolemy.moml.Location" value="140.0, 225.0">
  </property>
  <port name="output" class="ptolemy.actor.TypedIOPort">
    <property name="output"/>
  </port>
  <port name="trigger" class="ptolemy.actor.TypedIOPort">
    <property name="input"/>
    <property name="multiport"/>
  </port>
</entity>
<entity name="Sine Function" class="ptolemy.actor.lib.TrigFunction">
  <property name="function" class="ptolemy.kernel.util.StringAttribute" value="sin">
  <property name="style" class="ptolemy.actor.gui.style.ChoiceStyle">
    <property name="acos" class="ptolemy.kernel.util.StringAttribute" value="acos">
    </property>
    <property name="asin" class="ptolemy.kernel.util.StringAttribute" value="asin">
    </property>
    <property name="atan" class="ptolemy.kernel.util.StringAttribute" value="atan">
    </property>
    <property name="cos" class="ptolemy.kernel.util.StringAttribute" value="cos">
    </property>
    <property name="sin" class="ptolemy.kernel.util.StringAttribute" value="sin">
    </property>
    <property name="tan" class="ptolemy.kernel.util.StringAttribute" value="tan">
    </property>
  </property>
</property>
</entity>

```

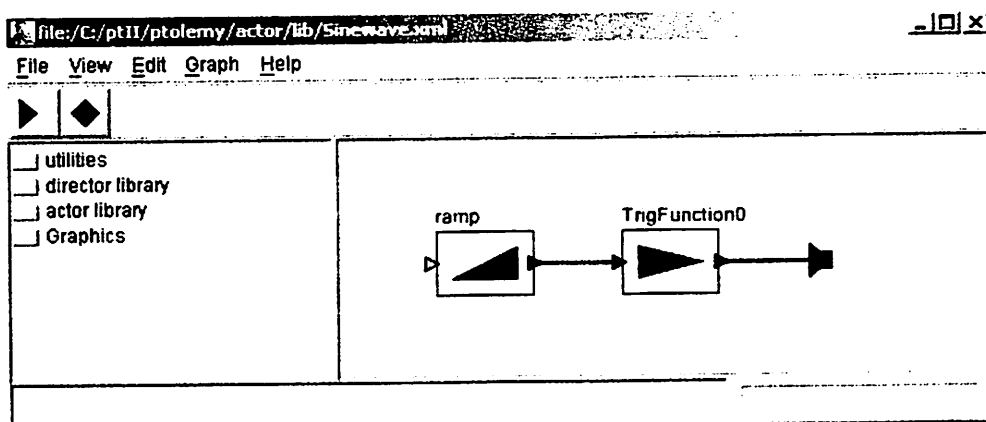

FIGURE 5.11. Rendition of the Sinewave class in Vergil 1.0.

```
<property name="_location" class="ptolemy.moml.Location" value="300.0, 225.0">
  </property>
  <port name="input" class="ptolemy.actor.TypedIOPort">
    <property name="input"/>
  </port>
  <port name="output" class="ptolemy.actor.TypedIOPort">
    <property name="output"/>
  </port>
</entity>
<relation name="relation1" class="ptolemy.actor.TypedIORelation">
</relation>
<relation name="relation2" class="ptolemy.actor.TypedIORelation">
</relation>
<link port="output" relation="relation1"/>
<link port="Ramp.output" relation="relation2"/>
<link port="Sine Function.input" relation="relation2"/>
<link port="Sine Function.output" relation="relation1"/>
</class>
```

C.2 Modulation

The top-level is defined in the file \$PTII/ptolemy/moml/demo/modulation.xml, which is listed below. The Vergil rendition of this model is shown in figure 5.12, and its execution is shown in figure 5.13.

```
<?xml version="1.0" standalone="no"?>
<!DOCTYPE entity PUBLIC "-//UC Berkeley//DTD MoML 1//EN"
  "http://ptolemy.eecs.berkeley.edu/xml/dtd/MoML_1.dtd">
<entity name="modulation" class="ptolemy.actor.TypedCompositeActor">
  <doc>Multiply a low-frequency sine wave (the signal) by a higher frequency one (the carrier).</doc>
  <property name="frequency1" class="ptolemy.data.expr.Parameter" value="PI*0.2">
    <doc>Frequency of the carrier</doc>
  </property>
  <property name="frequency2" class="ptolemy.data.expr.Parameter" value="PI*0.02">
    <doc>Frequency of the sinusoidal signal</doc>
  </property>
  <property name="director" class="ptolemy.domains.sdf.kernel.SDFDirector">
    <property name="iterations" class="ptolemy.data.expr.Parameter" value="100">
      <doc>Number of iterations in an execution.</doc>
    </property>
  </property>
</entity>
```

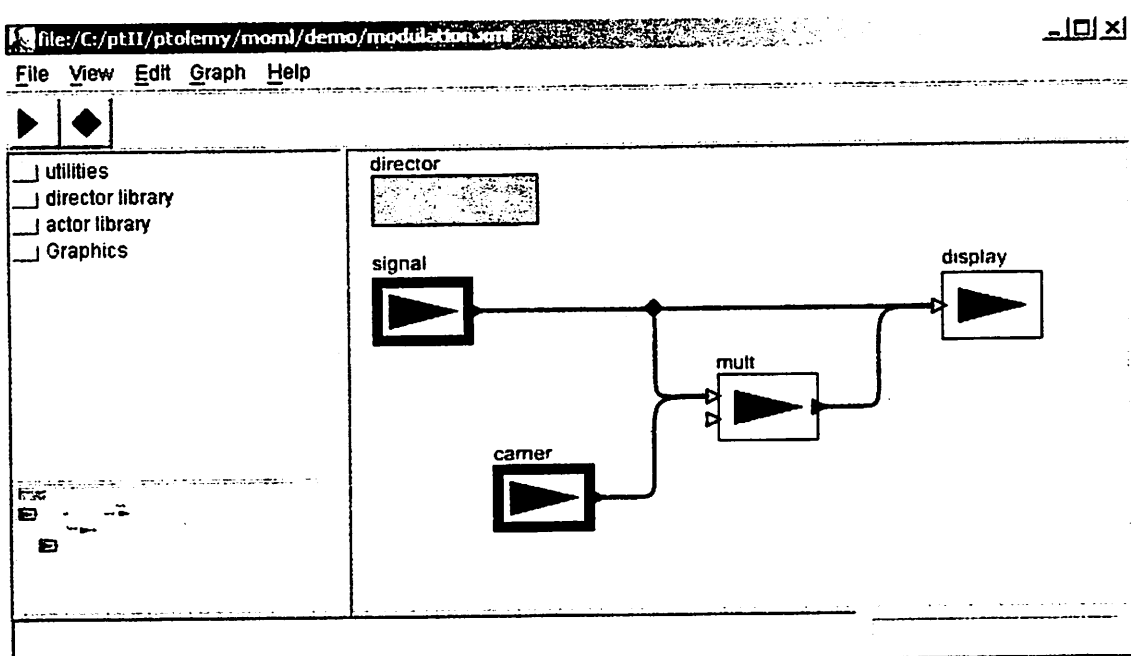

FIGURE 5.12. Rendition of the modulation model in Vergil 1.0.

```

<property name="vectorizationFactor" class="ptolemy.data.expr.Parameter" value="1">
</property>
<property name="_location" class="ptolemy.moml.Location" value="62.0, 23.0">
</property>
</property>
<entity name="carrier" class="ptolemy.actor.lib.Sinewave">
<doc>This composite actor generates a sine wave.</doc>
<property name="samplingFrequency" class="ptolemy.data.expr.Parameter" value="2*PI">
<doc>The sampling frequency, in the same units as the frequency.</doc>
</property>
<property name="frequency" class="ptolemy.data.expr.Parameter" value="frequency1">
<doc>The frequency of the sinusoid, in the same units as the sampling frequency.</doc>
</property>
<property name="phase" class="ptolemy.data.expr.Parameter" value="0.0">
<doc>The phase, in radians.</doc>
</property>
<property name="_location" class="ptolemy.moml.Location" value="215.0, 250.0">
</property>
</entity>
<entity name="signal" class="ptolemy.actor.lib.Sinewave">
<doc>This composite actor generates a sine wave.</doc>
<property name="samplingFrequency" class="ptolemy.data.expr.Parameter" value="2*PI">
<doc>The sampling frequency, in the same units as the frequency.</doc>
</property>
<property name="frequency" class="ptolemy.data.expr.Parameter" value="frequency2">
<doc>The frequency of the sinusoid, in the same units as the sampling frequency.</doc>
</property>
<property name="phase" class="ptolemy.data.expr.Parameter" value="0.0">
<doc>The phase, in radians.</doc>
</property>
<property name="_location" class="ptolemy.moml.Location" value="143.0, 135.0">
</property>
</entity>
<entity name="mult" class="ptolemy.actor.lib.MultiplyDivide">
<property name="_location" class="ptolemy.moml.Location" value="347.0, 196.0">
</property>
<port name="multiply" class="ptolemy.actor.TypedIOPort">
<property name="input"/>
<property name="multiport"/>
</port>
<port name="divide" class="ptolemy.actor.TypedIOPort">
<property name="input"/>

```

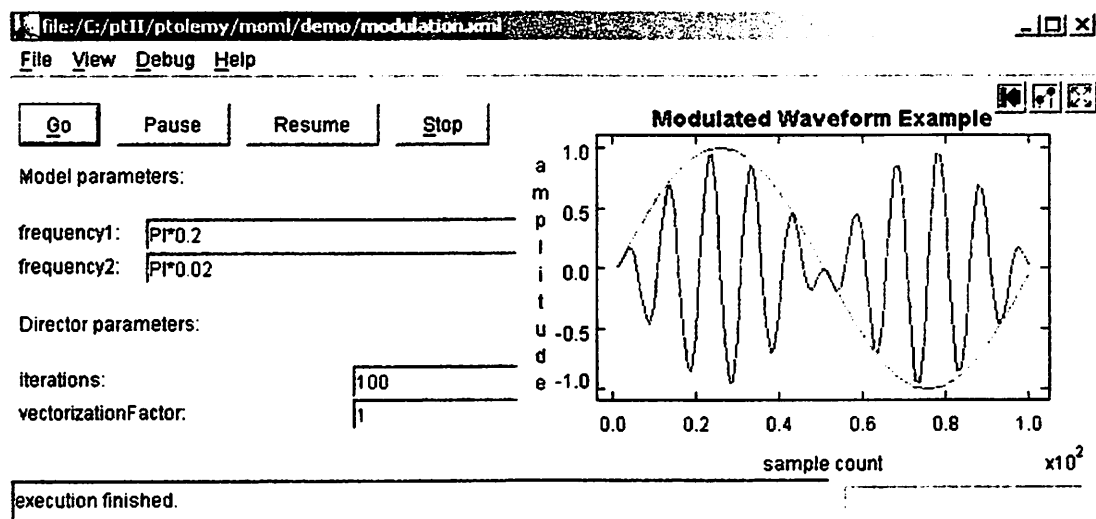

FIGURE 5.13. Execution window for the modulation model.

```

        <property name="multiport"/>
    </port>
    <port name="output" class="ptolemy.actor.TypedIOPort">
        <property name="output"/>
    </port>
</entity>
<entity name="display" class="ptolemy.actor.lib.gui.SequencePlotter">
    <property name="fillOnWrapup" class="ptolemy.data.expr.Parameter" value="true">
    </property>
    <property name="startingDataset" class="ptolemy.data.expr.Parameter" value="0">
    </property>
    <property name="xInit" class="ptolemy.data.expr.Parameter" value="0.0">
    </property>
    <property name="xUnit" class="ptolemy.data.expr.Parameter" value="1.0">
    </property>
    <property name="_location" class="ptolemy.moml.Location" value="479.99998474121094, 135.0">
    </property>
    <port name="input" class="ptolemy.actor.TypedIOPort">
        <property name="input"/>
        <property name="multiport"/>
    </port>
    <configure><?plotml
<!DOCTYPE plot PUBLIC "-//UC Berkeley//DTD PlotML 1//EN"
"http://ptolemy.eecs.berkeley.edu/xml/dtd/PlotML_1.dtd">
<plot>
<title>Modulated Waveform Example</title>
<xLabel>sample count</xLabel>
<yLabel>amplitude</yLabel>
<xRange min="1.0" max="100.0"/>
<yRange min="-1.0" max="1.0"/>
<noGrid/>
</plot>?>
    </configure>
</entity>
<relation name="r1" class="ptolemy.actor.TypedIORelation">
</relation>
<relation name="r2" class="ptolemy.actor.TypedIORelation">
    <vertex name="vertex0" class="ptolemy.moml.Vertex" value="279.0, 141.0">
    </vertex>
</relation>
<relation name="r3" class="ptolemy.actor.TypedIORelation">
</relation>
<link port="carrier.output" relation="r1"/>
<link port="signal.output" relation="r2"/>
<link port="mult.multiply" relation="r1"/>
<link port="mult.multiply" relation="r2"/>
<link port="mult.output" relation="r3"/>
<link port="display.input" relation="r2"/>
<link port="display.input" relation="r3"/>
</entity>

```

6

Custom Applets

*Authors: Edward A. Lee
Christopher Hylands*

6.1 Introduction

Ptolemy II models can be embedded in applets. In most cases, the MoMLApplet class can be used. For the MoMLApplet class, the model is given by a MoML file, which can be created using Vergil. The URL for the MoML file is given by the *modelURL* applet parameter in the HTML file.

Occasionally, however, it is useful to create an applet that exercises more control over the display and user interaction, or constructs or manipulates Ptolemy II models in ways that cannot be done in MoML. In such cases, the PtolemyApplet class can be useful. The MoMLApplet class is derived from PtolemyApplet, as shown in figure 6.1 (see appendix A of chapter 1 for UML syntax). Developers may either use PtolemyApplet directly or extend it to provide a more sophisticated user interface or a more elaborate method for model construction or manipulation.

The PtolemyApplet class provides four applet parameters:

- *background*: The background color, typically given as a hex number of the form "#rrggbb" where *rr* gives the red component, *gg* gives the green component, and *bb* gives the blue component.
- *controls*: This gives a comma-separated list of any subset of the words "buttons", "topParameters", and "directorParameters" (case insensitive), or the word "none". If this parameter is not given, then it is equivalent to giving "buttons", and only the control buttons mentioned above will be displayed. If the parameter is given, and its value is "none", then no controls are placed on the screen. If the word "topParameters" is included in the comma-separated list, then controls for the top-level parameters of the model are placed on the screen, below the buttons. If the word "directorParameters" is included, then controls for the director parameters are also included.
- *modelClass*: The fully qualified class name of a Java class that extends NamedObj. This class defines the model.
- *orientation*: This can have value "horizontal", "vertical", or "controls_only" (case insensitive). If it is "vertical", then the controls are placed above the visual elements of the Placeable actors. This

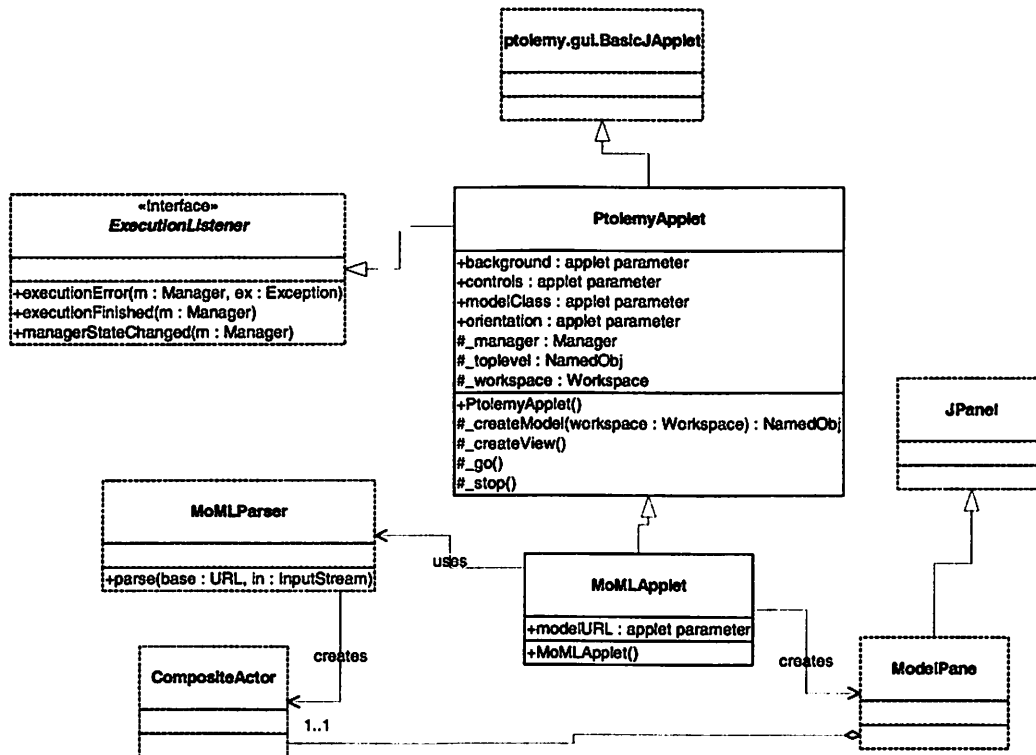

FIGURE 6.1. UML static structure diagram for PtolemyApplet, a convenience class for constructing applets. PtolemyApplet is in the ptolemy.actor.gui package.

is the default. If it is "horizontal", then the controls are placed to the left of the visual elements. If it is "controls_only" then no visual elements are placed.

The use of these applet parameters is explained in more detail below.

6.2 HTML Files Containing Applets

An applet is a Java class that can be referenced by an HTML file and accessed either locally or over the web and run in a secure manner on the local machine in a web browser. Unfortunately, most browsers available today are shipped with an earlier version of Java that does not provide features that Ptolemy II requires. The work around is to use Sun's Java Plug-In, which invokes the 1.3 version of the Java Runtime Environment (JRE), instead of the default Java runtime that is shipped with the browser.

Sample HTML for a custom applet is shown in figure 6.2. The incredible ugliness and awkwardness of this text is hopefully transitory, while browser vendors agree on how to properly support plug-ins. You should be able to essentially copy what we have, making very few modifications. An HTML file containing the segment shown in figure 6.2 can be found in \$PTII/doc/tutorial/TutorialApplet1.htm, where \$PTII is the home directory of the Ptolemy II installation. Also in that directory are a number of sample Java files for applets, each named TutorialApplet*n*.java, where *n* is an integer starting with 1. These files contain a series of applet definitions, each with increasing

sophistication, that are discussed below. Each applet has a corresponding TutorialApplet1.htm file.

Since our example applets are in a directory \$PTII/doc/tutorial, the codebase for the applet is “../” in figure 6.2, which is the directory \$PTII. This permits the applets to refer to any class in the Ptolemy II tree.

There are some parameters in the HTML in figure 6.2 that you may want to change. The width and the height, for example, specify the amount of space on the screen that the browser gives to the applet. Unfortunately, they are specified twice in the file.

Fortunately, getting the Java code right is easy compared to getting the HTML right.

6.3 Defining a Model in a Java File

PtolemyApplet supports two techniques for instantiating models:

1. The model can be defined as a Java class that extends NamedObj, with the class name given by the *modelClass* applet parameter in the HTML file.
2. The model can be defined as a Java class that extends PtolemyApplet and overrides the protected method *_createModel()* to create the model, and optionally overrides the *_createView()* method to create the visual display for the model.

The first of these is simpler, so we begin by explaining this technique.

6.3.1 A Model Class as a Composite Actor

If the model is defined in a Java class that extends NamedObj, then we can use the *modelClass* applet parameter to pass the class name to PtolemyApplet and invoke the PtolemyApplet code from the applet. PtolemyApplet will then construct our model and provide the basic functionality we need.

```
<OBJECT classid="clsid:8AD9C840-044E-11D1-B3E9-00805F499D93"
  width="700"
  height="300"
  codebase="http://java.sun.com/products/plugin/1.3/jinstall-13-win32.cab#Version=1,3,0,0">
  <PARAM NAME="code" VALUE="ptolemy/actor/gui/PtolemyApplet">
  <PARAM NAME="modelClass" VALUE="doc.tutorial.TutorialApplet1">
  <PARAM NAME="codebase" VALUE="../..">
  <PARAM NAME="type" VALUE="application/x-java-applet;version=1.3">
  <COMMENT>
  <EMBED type="application/x-java-applet;version=1.3"
    width="700"
    height="300"
    code="ptolemy/actor/gui/PtolemyApplet"
    modelClass="doc.tutorial.TutorialApplet1"
    codebase="../.."
    pluginspage="http://java.sun.com/products/plugin/1.3/plugin-install.html">
  </COMMENT>
  <NOEMBED>
  No JDK 1.3 support for applet!
  </NOEMBED>
  </EMBED>
</OBJECT>
```

FIGURE 6.2. An HTML segment that invokes the Java 1.3 Plug-in under both Netscape and Internet Explorer (it is regrettable how complex this is). This text can be found in \$PTII/doc/tutorial/TutorialApplet1.htm.

In figure 6.3 is a listing of an extremely simple applet that runs in the discrete-event (DE) domain. The first line declares that the applet is in a package called “doc.tutorial,” which matches the directory name relative to the codebase specified in the HTML file. In the next several lines, the applet imports the following classes from Ptolemy II:

- **TypedCompositeActor**: Our model extends TypedCompositeActor, which itself eventually extends NamedObj. This is the typical top-level container class for models in most Ptolemy II domains.
- **PtolemyApplet**: This base class creates a top-level composite actor called `_toplevel`, a manager called `_manager`, and a workspace called `_workspace` (all protected members of the class, shown in figure 6.1). We will see shortly how to use these.
- **Clock**: This is an actor that generates a clock signal, which by default is a sequence of events placed one time unit apart and alternating in value between 1 and 0.
- **TimedPlotter**: This is an actor that plots functions of time.
- **DEDirector**: The discrete-event domain director that manages execution of the model.
- **IllegalActionException**: This exception thrown on an attempt to perform an action that would result in an inconsistent or contradictory data structure if it were allowed to complete.
- **NameDuplicationException**: This exception is thrown on an attempt to add a named object to a collection that requires unique names, and finding that there already is an object by that name in the collection.
- **Workspace**: An object for synchronization and version tracking of groups of objects.

Next, the construct:

```
package doc.tutorial;
import ptolemy.actor.TypedCompositeActor;
import ptolemy.actor.gui.PtolemyApplet;
import ptolemy.actor.lib.Clock;
import ptolemy.actor.lib.gui.TimedPlotter;
import ptolemy.domains.de.kernel.DEDirector;
import ptolemy.kernel.util.IllegalActionException;
import ptolemy.kernel.util.NameDuplicationException;
import ptolemy.kernel.util.Workspace;

public class TutorialApplet1 extends TypedCompositeActor {
    public TutorialApplet1(Workspace workspace)
        throws IllegalActionException, NameDuplicationException {
        super(workspace);

        // Create the director
        DEDirector director = new DEDirector(this, "director");
        setDirector(director);
        director.stopTime.setExpression("10");

        // Create two actors.
        Clock clock = new Clock(this, "clock");
        TimedPlotter plotter = new TimedPlotter(this, "plotter");

        // Connect them.
        connect(clock.output, plotter.input);
    }
}
```

FIGURE 6.3. An extremely simple applet that runs in the DE domain. This text can be found in `$PTII/tutorial/TutorialApplet1.java`.

```
public class TutorialApplet1 extends TypedCompositeActor { ... }
```

defines a class called `TutorialApplet1` that extends `TypedCompositeActor`. The new class provides a constructor that takes one argument, the `Workspace` into which to place the model:

```
public TutorialApplet1(Workspace workspace)
    throws IllegalArgumentException, NameDuplicationException {...}
```

The body of the constructor first invokes the constructor in the base class with:

```
super(workspace);
```

It then creates a DE director.

```
DEDirector director = new DEDirector(this, "director");
```

The director implements the discrete-event model of computation, which controls when the component actors are invoked and how they communicate. The next line tells the model to use the director:

```
setDirector(director);
```

The next line sets a director parameter that controls the duration of an execution of the model:

```
director.stopTime.setExpression("10");
```

If we don't set the stop time, then the model will run forever, or until the user hits the stop button. The next few lines create an instance of `Clock` and an instance of `TimedPlotter`, and connect them together:

```
// Create two actors.
Clock clock = new Clock(this, "clock");
TimedPlotter plotter = new TimedPlotter(this, "plotter");

// Connect them.
connect(clock.output, plotter.input);
```

The constructors for `Clock` and `TimedPlotter` take two arguments, the container (a composite actor), and an arbitrary name (which must be unique within the container). This example uses the variable `this`, which refers to the class we are creating, a `TypedCompositeActor`, as a container. The connection is accomplished by the `connect()` method of the composite actor, which takes two ports as arguments. Instances of `Clock` have one output port, `output`, which is a public member, and instances of `TimedPlotter` have one input port, `input`, which is also a public member.

6.3.2 Compiling

To compile this class definition, you must tell the Java compiler where to find the Ptolemy classes by using the `-classpath` command line argument. For example, in `bash` or a similar shell, assuming the

environment variable PTII is set to the location of the Ptolemy II installation:

```
bash-2.02$ cd $PTII/doc/tutorial
bash-2.02$ javac -classpath ../../ TutorialApplet1.java
```

(The part before the "\$" is the prompt issued by bash). Java requires that classes are defined in files that have the same name as the class. The Ptolemy II style convention is to extend this notion and have HTML files have the same name as the model they use, so the HTML file that runs the model in TutorialApplet1.java is named TutorialApplet1.htm.

You should now be able to run the applet with the command:

```
bash-2.02$ appletviewer TutorialApplet1.htm
```

The result of running the applet is a new window which should look like that shown in figure 6.4. The following applet parameters are useful to customize the display:

- *controls*: This gives a comma-separated list of any subset of the words "buttons", "topParameters", and "directorParameters" (case insensitive), or the word "none". If this parameter is not given, then it is equivalent to giving "buttons", and only the control buttons mentioned above will be displayed. If the parameter is given, and its value is "none", then no controls are placed on the screen. If the word "topParameters" is included in the comma-separated list, then controls for the top-level parameters of the model are placed on the screen, below the buttons. If the word "directorParameters" is included, then controls for the director parameters are also included.
- *orientation*: This can have value "horizontal", "vertical", or "controls_only" (case insensitive). If it is "vertical", then the controls are placed above the visual elements of the Placeable actors. This is the default. If it is "horizontal", then the controls are placed to the left of the visual elements. If it is "controls_only" then no visual elements are placed.

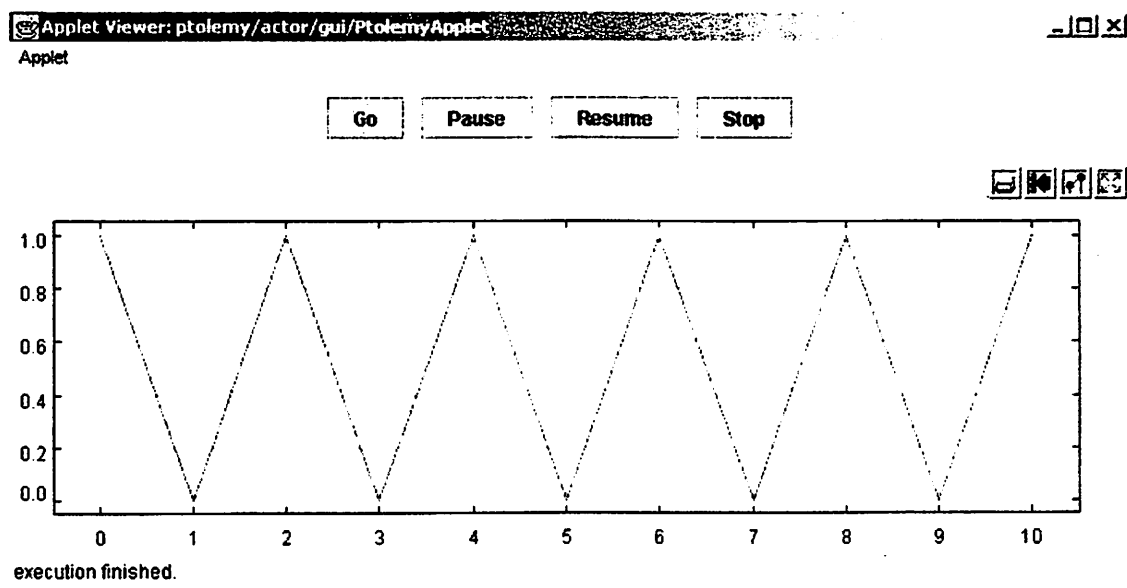

FIGURE 6.4. Result of running the (all too simple) applet of figure 6.3.

For example, if the HTML includes the following lines within the OBJECT element:

```
<PARAM NAME="controls" VALUE="buttons, directorParameters">
<PARAM NAME="orientation" VALUE="horizontal">
```

and the following lines within the EMBED element:

```
controls="buttons, directorParameters"
orientation="horizontal"
```

then the result of execution looks like figure 6.5. Regrettably, both must be added or the applet will behave differently in Internet Explorer and Netscape. The layout is now horizontal, with the controls to the left of the displays instead of on top, and the director parameters have been made available to the applet user.

6.3.3 Executing the Model in an Application

A model created as above can also be executed as an application, in addition to running it as a mode. Any class that extends CompositeActor, the base class for TypedCompositeActor, can be executed using the CompositeActorApplication class, shown in figure 6.6. The command is simply:

```
bash-2.02$ cd $PTII/doc/tutorial
bash-2.02$ java -classpath ../.. \
ptolemy.actor.gui.CompositeActorApplication \
-class doc.tutorial.TutorialApplet1
```

The result will look like figure 6.5. This ability to use the same class definition in both an applet and an

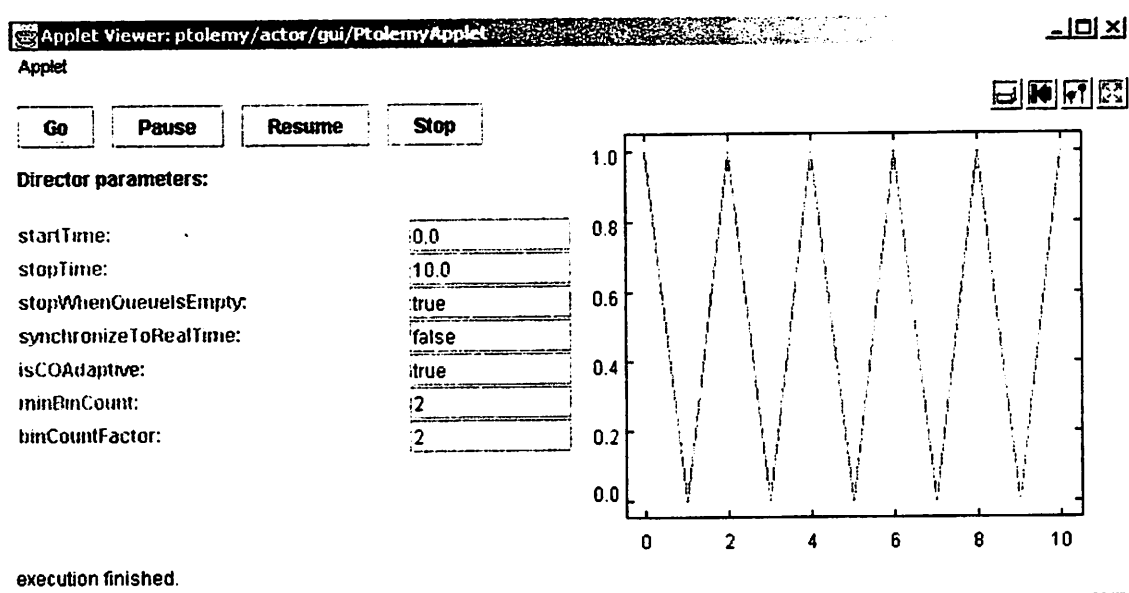

FIGURE 6.5. Result of running the applet of figure 6.3 with horizontal layout, and including the director parameters.

application is convenient.

6.3.4 Extending PtolemyApplet

Another way to use PtolemyApplet is to define the model as a Java class that extends it and overrides the protected method `_createModel()` to create a model and optionally overrides the `_createView()` protected method to create a custom display. Extending PtolemyApplet gives the developer the opportunity to control the look and feel of the applet in as much detail as necessary, including creating completely customized displays and controls.

In figure 6.7 we define the same applet by extending PtolemyApplet instead of extending TypedCompositeActor. This class overrides the `_createView()` method, which takes a Workspace as an argument and returns a NamedObj. Note that since we are no longer extending TypedCompositeActor, we need to instantiate a TypedCompositeActor named `oplevel` and use it where we used "this" in the previous example. Otherwise, the code is very similar to that in figure 6.3.

We can improve this applet by giving the user more specialized control over its execution.

6.3.5 Using Model Parameters

Typically, a model has a set of parameters that you wish for the user to be able to control in the applet. Suppose for example that in the above applet you wish for the user to be able to control the stop time of the director and the period of the clock actor. You can modify the Java code in figure 6.3 as shown in figure 6.8. This code uses the Parameter class to define two top-level parameters. The following lines create the top-level parameters:

```
Parameter stopTime = new Parameter(this, "stopTime");
Parameter clockPeriod = new Parameter(this, "clockPeriod");
```

The default values of these two parameters are set by the following lines:

```
stopTime.setExpression("10.0");
clockPeriod.setExpression("2.0");
```

Finally, the values of the director and Clock actor parameters are coupled to these top-level parameters

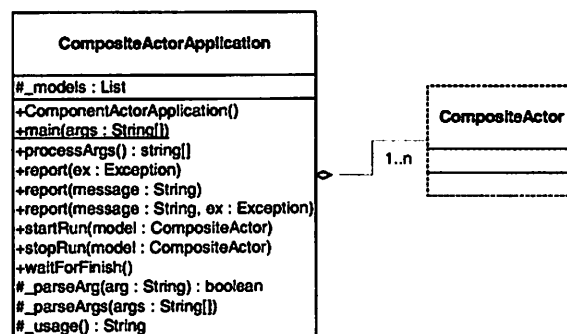

FIGURE 6.6. Any class that extends CompositeActor can be executed using the CompositeActorApplication class.

by the lines

```
director.stopTime.setExpression("stopTime");
clock.period.setExpression("clockPeriod");
```

The expressions being set here can be much more elaborate. The expression language is documented in the Data Package chapter. Here, the expressions each contain a single variable reference, referring to the top-level parameters by name.

In order for the top-level parameters to appear in the controls of an applet, we must configure the HTML file as shown in figure 6.9. The lines

```
<PARAM NAME="controls" VALUE="buttons, topParameters">
```

and:

```
controls="buttons, topParameters"
```

accomplish the objective. The result of invoking the appletviewer on the HTML file in figure 6.9 is shown in figure 6.10.

6.3.6 Adding Custom Actors

The intent of Ptolemy II is to have a reasonably rich set of actors in the actor libraries. However, it is anticipated that model builders will often need to define their own, custom actors. This is relatively

```
package doc.tutorial;
import ptolemy.actor.TypedCompositeActor;
import ptolemy.actor.gui.PtolemyApplet;
import ptolemy.actor.lib.Clock;
import ptolemy.actor.lib.gui.TimedPlotter;
import ptolemy.domains.de.kernel.DEDirector;
import ptolemy.kernel.util.NamedObj;
import ptolemy.kernel.util.Workspace;

public class TutorialApplet2 extends PtolemyApplet {
    public NamedObj _createModel(Workspace workspace)
        throws Exception {
        TypedCompositeActor toplevel = new TypedCompositeActor(workspace);

        // Create the director.
        DEDirector director = new DEDirector(toplevel, "director");
        director.stopTime.setExpression("10");

        // Create two actors.
        Clock clock = new Clock(toplevel, "clock");
        TimedPlotter plotter = new TimedPlotter(toplevel, "plotter");

        // Connect them.
        toplevel.connect(clock.output, plotter.input);
        return toplevel;
    }
}
```

FIGURE 6.7. A simple applet that extends PtolemyApplet instead of extending TypedCompositeActor. This text can be found in \$PTII/doc/tutorial/TutorialApplet2.java.

easy to do, as discussed in the Designing Actors chapter. By convention, when a specialized actor is created for a particular applet or application, we store that actor in the same directory with the applet or application, rather than in the actor libraries. The actor libraries are for generic, reusable actors.

6.3.7 Using Jar Files

A jar file is a Java Archive File that contains multiple .class files. Applets that are being downloaded over the net will start up more quickly if all the relevant Java .class files are collected together into one or more jar files. This dramatically reduces the number of HTTP transactions.

Models in the Ptolemy II demo directories typically use three separate jar files:

- `ptolemy/ptsupport.jar` — A jar file containing classes from `ptolemy.kernel`, `ptolemy.actor` and other packages, see `$PTII/ptolemy/makefile` for a complete list;
- `ptolemy/domains/domain/domain.jar` — A domain specific jar file such as `de.jar`, where *domain* is replaced by a domain name;
- `ptolemy/domains/domain/demo/Demo/Demo.jar` — A model-specific jar file. Models with sophis-

```
package doc.tutorial;
import tolemy.actor.TypedCompositeActor;
import tolemy.actor.gui.PtolemyApplet;
import tolemy.actor.lib.Clock;
import tolemy.actor.lib.gui.TimedPlotter;
import tolemy.data.expr.Parameter;
import tolemy.domains.de.kernel.DEDirector;
import tolemy.kernel.util.IllegalActionException;
import tolemy.kernel.util.NameDuplicationException;
import tolemy.kernel.util.Workspace;

public class TutorialApplet3 extends TypedCompositeActor {
    public TutorialApplet3(Workspace workspace)
        throws IllegalActionException, NameDuplicationException {
        super(workspace);

        // Create model parameters
        Parameter stopTime = new Parameter(this, "stopTime");
        Parameter clockPeriod = new Parameter(this, "clockPeriod");

        // Give the model parameters default values.
        stopTime.setExpression("10.0");
        clockPeriod.setExpression("2.0");

        // Create the director
        DEDirector director = new DEDirector(this, "director");
        setDirector(director);

        // Create two actors.
        Clock clock = new Clock(this, "clock");
        TimedPlotter plotter = new TimedPlotter(this, "plotter");

        // Set the user controlled parameters.
        director.stopTime.setExpression("stopTime");
        clock.period.setExpression("clockPeriod");

        // Connect the actors.
        connect(clock.output, plotter.input);
    }
}
```

FIGURE 6.8. Code that adds model parameters control to the applet. This code can be found in `$PTII/doc/tutorial/TutorialApplet3.java`.

ticated GUIs that use Listeners can result in multiple .class files per .java file, so having a jar file can help download speeds.

The third jar file is not needed if the model resides in a single .class file. To use jar files, you must modify the HTML shown in figure 6.2 to read as shown in figure 6.11.

An important downside of using jar files is that during Java development, one must regenerate the jar files each time a Java file is recompiled. If you are developing an applet, you may want to avoid using jar files, or only include jar files that are from packages that are not actively being developed.

How Jar files are built. To know which jar files in the Ptolemy II tree you might need for your applet, you need to know how the jar files are constructed. The short story is that every package has a jar file that includes subpackages. Since the package structure mirrors the directory structure, it is easy to peruse the Ptolemy II tree (rooted at \$PTII) and look for jar files. There are a few exceptions; for example, domain jar files, such as de.jar, do not include the demos, even though the demos are in a subpackage of the domain package.

The longer story is that the make install rule in Ptolemy II makefiles builds various jar files that contain the Ptolemy II .class files. In general, make install builds a jar file in each directory that contains more than one .class file. If a directory contains subdirectories that in turn contain jar files,

```
<HTML>
<HEAD>
<META HTTP-EQUIV="Content-Type" CONTENT="text/html; charset=iso-8859-1">
<TITLE>TutorialApplet3</TITLE>
</HEAD>
<BODY>
<H1>TutorialApplet3</H1>
<OBJECT classid="clsid:8AD9C840-044E-11D1-B3E9-00805F499D93"
width="700"
height="300"
codebase="http://java.sun.com/products/plugin/1.3/jinstall-13-win32.cab#Version=1,3,0,0">
<PARAM NAME="code" VALUE="ptolemy/actor/gui/PtolemyApplet">
<PARAM NAME="modelClass" VALUE="doc.tutorial.TutorialApplet3">
<PARAM NAME="controls" VALUE="buttons, topParameters">
<PARAM NAME="orientation" VALUE="horizontal">
<PARAM NAME="codebase" VALUE="..">
<PARAM NAME="type" VALUE="application/x-java-applet;version=1.3">
<COMMENT>
<EMBED type="application/x-java-applet;version=1.3"
width="700"
height="300"
code="ptolemy/actor/gui/PtolemyApplet"
modelClass="doc.tutorial.TutorialApplet3"
controls="buttons, topParameters"
orientation="horizontal"
codebase=".."
pluginspage="http://java.sun.com/products/plugin/1.3/plugin-install.html">
</COMMENT>
<NOEMBED>
No JDK 1.3 support for applet!
</NOEMBED>
</EMBED>
</OBJECT>
<p>This applet uses the <code>modelClass</code> PtolemyApplet applet parameter.
</BODY>
</HTML>
```

FIGURE 6.9. The HTML that displays model parameters for the applet user to control. This file can be found in \$PTII/doc/tutorial/TutorialApplet3.htm

then the subdirectory jar files are expanded and included in the upper level jar file. For example, the \$PTII/ptolemy/kernel/makefile contains:

```
# Used to build jar files
```

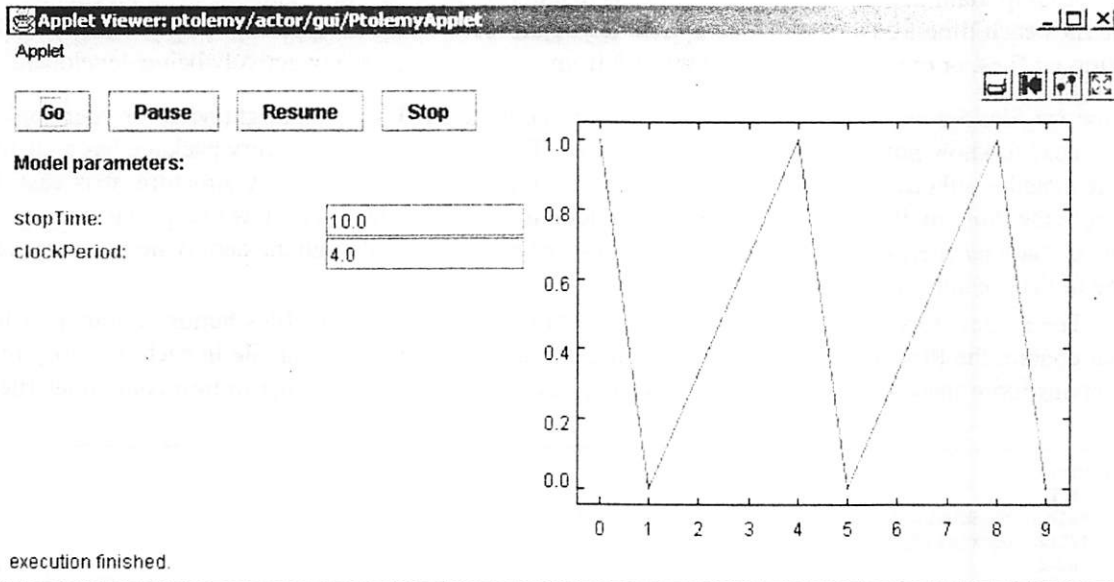

FIGURE 6.10. Result of running the applet of figure 6.8 with horizontal layout, and including the top-level parameters.

```
<OBJECT classid="clsid:8AD9C840-044E-11D1-B3E9-00805F499D93"
  width="700"
  height="300"
  codebase="http://java.sun.com/products/plugin/1.3/jinstall-13-win32.cab#Version=1,3,0,0">
<PARAM NAME="code" VALUE="doc.tutorial.TutorialApplet5.class">
<PARAM NAME="codebase" VALUE="../../">
<PARAM NAME="archive" VALUE="
  ptolemy/ptsupport.jar,
  ptolemy/domains/de/de.jar">
<PARAM NAME="type" VALUE="application/x-java-applet;version=1.3">
<COMMENT>
<EMBED type="application/x-java-applet;version=1.3"
  width="700"
  height="300"
  code="doc/tutorial/TutorialApplet5.class"
  codebase="../../"
  archive="
    ptolemy/ptsupport.jar,
    ptolemy/domains/de/de.jar"
  pluginspage="http://java.sun.com/products/plugin/1.3/plugin-install.html">
</COMMENT>
<NOEMBED>
No JDK 1.3 support for applet!
</NOEMBED>
</EMBED>
</OBJECT>
```

FIGURE 6.11. An HTML segment that modifies that of figure 6.2 to use jar files. This text can be found in SPTII/doc/tutorial/tutorialJar.htm.

```
PTPACKAGE = ptolemy.kernel
PTDIST = $(PTPACKAGE)$ (PTVERSION)
PTCLASSJAR =
# Include the .class files from these jars in PTCLASSALLJAR
PTCLASSALLJARS = \
    util/util.jar
PTCLASSALLJAR = kernel.jar
```

In this case make `install` will build a jar file called `kernel.jar` that contains all the `.class` files in the current directory and the contents of `$PTII/ptolemy/kernel/util/util.jar`.

6.3.8 Hints for Developing Applets

Unfortunately, Java Plug-in technology is fairly immature. In the current version, we have encountered a number of problems, and have found workarounds that we can share. Other hints may be found in `$PTII/doc/coding/applets.htm`

Processes Linger After the Browser Quits. Sometimes, after running an applet under a browser, a process remains live even after the browser has been exited. This appears to be a bug with the just-in-time (JIT) compiler included in the plug-in. You can configure the plug-in to disable the JIT. On a Windows installation, the plug-in comes with a control panel (look under Programs in the Start menu). Select the “advanced” tab, and disable the JIT. This will noticeably slow down your applets, but you will not have to kill lingering processes. We have not seen this problem since upgrading to the 1.3 version of the Java Plug-in.

Difficulty Reloading Applets. While developing applets, it is helpful to be able to reload the applet after modifying the Java code. In Netscape, you must use Shift-reload, and in IE, Control-reload. Unfortunately, this does not always cause the applet to be reloaded. A workaround is described on the Sun website, <http://java.sun.com/products/plugin/1.3/docs/controlpanel.html>, which says:

“Cache JARs in memory. If this option is checked, the applet classes already loaded will be cached and reused when applet is reloaded. This allows much more efficient memory use. You should leave this option unchecked if you are debugging an applet or are always interested in loading the latest applet classes. The default setting is to cache JARs in memory. Warning: turning off this option makes it more likely that you will get OutOfMemoryErrors, as this reduces sharing of memory.”

This option is under the “basic” tab of the same control panel described in the previous hint. Rather than using the browser to view your applet each time you modify the Java code, you may find it easier to use the standalone `appletviewer` command provided with the JDK.

The following code defines a custom applet that displays a simple window with a title bar and a text area. The applet is named "CustomApplet" and is located in the "com.example" package.

```

import java.awt.*;
import java.applet.*;

public class CustomApplet extends JApplet {
    private JTextArea textArea;

    public void init() {
        textArea = new JTextArea(10, 30);
        add(textArea);
    }
}
    
```

The code defines a class `CustomApplet` that extends `JApplet`. In the `init` method, a `JTextArea` object is created with 10 rows and 30 columns, and it is added to the applet's content pane.

To run this applet, you need to create an HTML file that references the applet. The following code shows an example of an HTML file named "applet.html":

```

<html>
<head>
<title>Custom Applet</title>
</head>
<body>
<applet code="CustomApplet" width="300" height="100">
</applet>
</body>
</html>
    
```

The HTML file uses the `<applet>` tag to embed the `CustomApplet` class. The `code` attribute specifies the class name, and the `width` and `height` attributes specify the size of the applet.

To run the applet, you can use the `java` command to launch the Java runtime environment and specify the HTML file:

```

java -Djava.class.path=. com.example.CustomApplet applet.html
    
```

This command will run the `CustomApplet` class, which will display the window defined in the HTML file.

PART 2:

SOFTWARE ARCHITECTURE

The chapters in this part describe the software architecture of Ptolemy II. The first chapter covers the kernel package, which provides a set of Java classes supporting clustered graph topologies for models. Cluster graphs provide a very general abstract syntax for component-based modeling, without assuming or imposing any semantics on the models. The actor package begins to add semantics by providing basic infrastructure for data transport between components. The data package provides classes to encapsulate the data that is transported. It also provides an extensible type system and an interpreted expression language. The graph package provides graph-theoretic algorithms that are used in the type system and by schedulers in the individual domains. The plot package provides a visual data plotting utility that is used in many of the applets and applications. Vergil is the graphical front end to Ptolemy II and Vergil itself uses Ptolemy II to describe its own configuration.

1. The first part of the document is a list of names and addresses of the members of the committee.

2. The second part of the document is a list of names and addresses of the members of the committee.

3. The third part of the document is a list of names and addresses of the members of the committee.

7

The Kernel

Author: Edward A. Lee
Contributors: John Davis, II
Ron Galicia
Mudit Goël
Christopher Hylands
Jie Liu
Xiaojun Liu
Lukito Muliadi
Steve Neuendorffer
John Reekie
Neil Smyth

7.1 Abstract Syntax

The kernel defines a small set of Java classes that implement a data structure supporting a general form of uninterpreted clustered graphs, plus methods for accessing and manipulating such graphs. These graphs provide an abstract syntax for netlists, state transition diagrams, block diagrams, etc. An *abstract syntax* is a conceptual data organization. It can be contrasted with a *concrete syntax*, which is a syntax for a persistent, readable representation of the data, such as EDIF for netlists. A particular graph configuration is called a *topology*.

Although this idea of an uninterpreted abstract syntax is present in the original Ptolemy kernel [14], in fact the original Ptolemy kernel has more semantics than we would like. It is heavily biased towards dataflow, the model of computation used most heavily. Much of the effort involved in implementing models of computation that are very different from dataflow stems from having to work around certain assumptions in the kernel that, in retrospect, proved to be particular to dataflow.

A topology is a collection of *entities* and *relations*. We use the graphical notation shown in figure 7.1, where entities are depicted as rounded boxes and relations as diamonds. Entities have *ports*, shown as filled circles, and relations connect the ports. We consistently use the term *connection* to

denote the association between connected ports (or their entities), and the term *link* to denote the association between ports and relations. Thus, a connection consists of a relation and two or more links.

The use of ports and hierarchy distinguishes our topologies from mathematical graphs. In a mathematical graph, an entity would be a vertex, and an arc would be a connection between entities. A vertex could be represented in our schema using entities that always contain exactly one port. In a directed graph, the connections are divided into two subsets, one consisting of incoming arcs, and the other of outgoing arcs. The vertices in such a graph could be represented by entities that contain two ports, one for incoming arcs and one for outgoing arcs. Thus, in mathematical graphs, entities always have one or two ports, depending on whether the graph is directed. Our schema generalizes this by permitting an entity to have any number of ports, thus dividing its connections into an arbitrary number of subsets.

A second difference between our graphs and mathematical graphs is that our relations are multi-way associations whereas an arc in a graph is a two-way association. A third difference is that mathematical graphs normally have no notion of hierarchy (clustering).

Relations are intended to serve as mediators, in the sense of the Mediator design pattern of Gamma, *et al.* [28]. "Mediator promotes loose coupling by keeping objects from referring to each other explicitly..." For example, a relation could be used to direct messages passed between entities. Or it could denote a transition between states in a finite state machine, where the states are represented as entities. Or it could mediate rendezvous between processes represented as entities. Or it could mediate method calls between loosely associated objects, as for example in remote method invocation over a network.

7.2 Non-Hierarchical Topologies

The classes shown in figure 7.2 support non-hierarchical topologies, like that shown in figure 7.1. Figure 7.2 is a UML static structure diagram (see appendix A of chapter 1).

7.2.1 Links

An Entity contains any number of Ports; such an aggregation is indicated by the association with an unfilled diamond and the label "0..n" to show that the Entity can contain any number of Ports, and the label "0..1" to show that the Port is contained by at most one Entity. This association uses the NamedList class shown at the bottom of figure 7.2 and defined fully in figure 7.3. There is exactly one

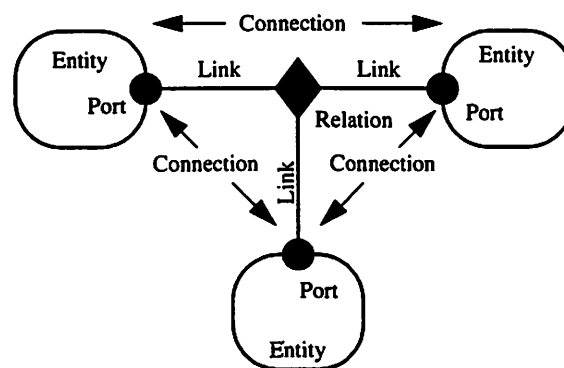

FIGURE 7.1. Visual notation and terminology.

instance of NamedList associated with Entity, and it aggregates the ports.

A Port is associated with any number of Relations (the association is called a *link*), and a Relation is associated with any number of Ports. Link associations use CrossRefList, shown in figure 7.3. There is exactly one instance of CrossRefList associated with each port and each relation. The links define a web of interconnected entities.

On the port side, links have an order. They are indexed from 0 to *n*, where *n* is the number returned by the numLinks() method of Port.

7.2.2 Consistency

A major concern in the choice of methods to provide and in their design is maintaining consistency. By *consistency* we mean that the following key properties are satisfied:

- Every link between a port and a relation is symmetric and bidirectional. That is, if a port has a link to a relation, then the relation has a link back to that port.
- Every object that appears on a container's list of contained objects has a back reference to its container.

In particular, the design of these classes ensures that the `_container` attribute of a port refers to an entity that includes the port on its `_portList`. This is done by limiting the access to both attributes. The only way to specify that a port is contained by an entity is to call the `setContainer()` method of the port. That method guarantees consistency by first removing the port from any previous container's `_portList`,

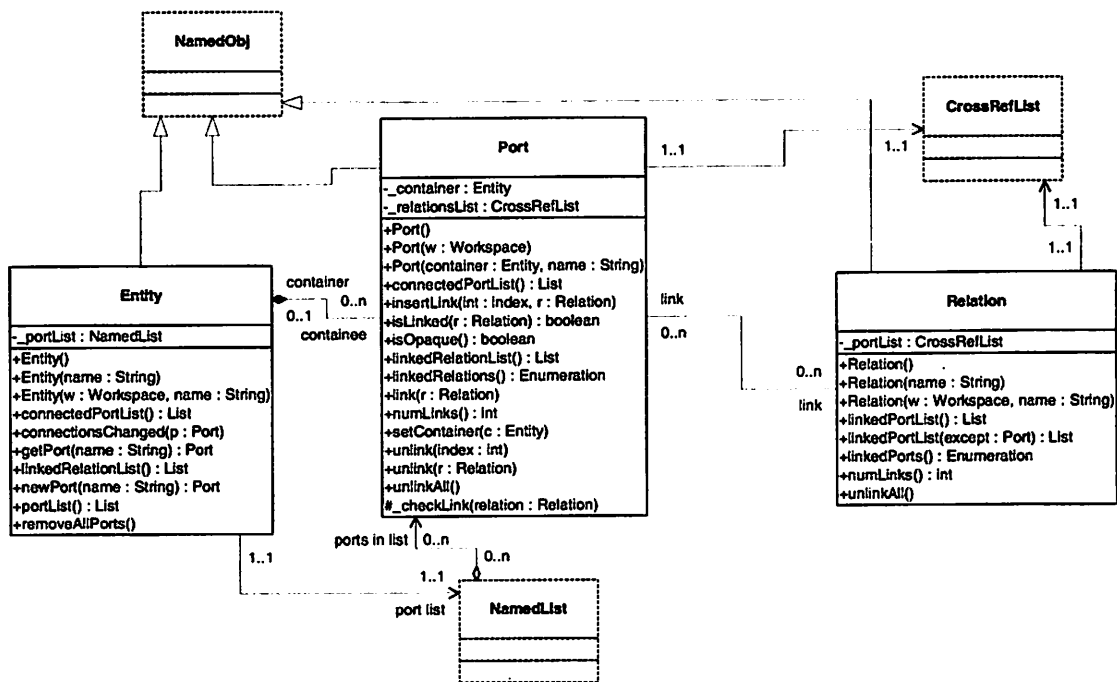

FIGURE 7.2. Key classes in the kernel package and their methods supporting basic (non-hierarchical) topologies. Methods that override those defined in a base class or implement those in an interface are not shown. The “+” indicates public visibility, “#” indicates protected, and “-” indicates private. Capitalized methods are constructors. The classes shown with dashed outlines are in the kernel.util subpackage.

then adding it to the new container's port list. A port is removed from an entity by calling `setContainer()` with a null argument.

A change in a containment association involves several distinct objects, and therefore must be atomic, in the sense that other threads must not be allowed to intervene and modify or access relevant attributes halfway through the process. This is ensured by synchronization on the workspace, as explained below in section 7.6. Moreover, if an exception is thrown at any point during the process of changing a containment association, any changes that have been made must be undone so that a consistent state is restored.

7.3 Support Classes

The kernel package has a subpackage called `kernel.util` that provides underlying support classes, some of which are shown in figure 7.3. These classes define notions basic to Ptolemy II of containment, naming, and parameterization, and provide generic support for relevant data structures.

7.3.1 Containers

Although these classes do not provide support for constructing clustered graphs, they provide rudimentary support for *container* associations. An instance of these classes can have at most one container. That container is viewed as the owner of the object, and "managed ownership" [47] is used as a central tool in thread safety, as explained in section 7.6 below.

In the base classes shown in figure 7.2, only an instance of `Port` can have a non-null container. It is the only class with a `setContainer()` method. Instances of all other classes have no container, and their `getContainer()` method will return null. In the classes of figure 7.3, only `Attribute` has a `setContainer()` method.

Every object is associated with exactly one instance of `Workspace`, as shown in figure 7.3, but the workspace is not viewed as a container. The workspace is defined when an object is constructed, and no methods are provided to change it. It is said to be *immutable*, a critical property in its use for thread safety.

7.3.2 Name and Full Name

The `Nameable` interface supports hierarchy in the naming so that individual named objects in a hierarchy can be uniquely identified. By convention, the *full name* of an object is a concatenation of the full name of its container, if there is one, a period ("."), and the name of the object. The full name is used extensively for error reporting. A top-level object always has a period as the first character of its full name. The full name is returned by the `getFullName()` method of the `Nameable` interface.

`NamedObj` is a concrete class implementing the `Nameable` interface. It also serves as an aggregation of attributes, as explained below in section 7.3.4.

Names of objects are only required to be unique within a container. Thus, even the full name is not assured of being globally unique.

Here, names are a property of the instances themselves, rather than properties of an association between entities. As argued by Rumbaugh in [84], this is not always the right choice. Often, a name is more properly viewed as a property of an association. For example, a file name is a property of the association between a directory and a file. A file may have multiple names (through the use of symbolic links). Our design takes a stronger position on names, and views them as properties of the object,

much as we view the name of a person as a property of the person (vs. their employee number, for example, which is a property of their association with an employer).

7.3.3 Workspace

Workspace is a concrete class that implements the Nameable interface, as shown in figure 7.3. All objects in a topology are associated with a workspace, and almost all operations that involve multiple objects are only supported for objects in the same workspace. This constraint is exploited to ensure thread safety, as explained in section 7.6 below.

7.3.4 Attributes

In almost all applications of Ptolemy II, entities, ports, and relations need to be parameterized. The base classes shown in figure 7.3 provide for these objects to have any number of instances of the Attribute class attached to them. Attribute is a NamedObj that can be contained by another NamedObj, and serves as a base class for parameters.

Attributes are added to a NamedObj by calling their setContainer() method and passing it a reference to the container. They are removed by calling setContainer() with a null argument. The NamedObj class provides the getAttribute() method, which takes an attribute name as an argument and returns the attribute, and the attributeList() method, which returns a list of the attributes contained by the object.

By itself, an instance of the Attribute class carries only a name, which may not be sufficient to parameterize objects. Several derived classes implement the Settable interface, which indicates that they can be assigned a value via a string. A simple attribute implementing the Settable interface is the StringAttribute. It has a value that can be any string. A derived class called Variable that implements the Settable interface is defined in the data package. The value of an instance of Variable is typically an arithmetic expression.

An attribute that is not an instance of Settable is called a pure attribute. Its mere presence has significance.

Attribute names can be any string that does not include periods, but it is recommend to stick to alphanumeric characters, the space character, and the underscore. Names beginning with an underscore are reserved for system use. The following names, for example, are in use:

Table 7.1: Names of special attributes

name	class	use
_doc	ptolemy.actor.gui.Documentation	Default documentation attribute name.
_generator	ptolemy.codegen.saveasjava.GeneratorTableauAttribute	Parameters for code generators.
_icon	ptolemy.vergil.toolbox.EditorIcon	Icon renderer attribute.
_iconDescription	ptolemy.kernel.util.StringAttribute	XML description of an icon.
_library	ptolemy.moml.LibraryAttribute	Associates an actor library with a model.
_libraryMarker	ptolemy.kernel.util.Attribute	Marks its container as a library vs. a composite entity.
_location	ptolemy.moml.Location	Records the location of a visual rendition of an object.
_parser	ptolemy.moml.ParserAttribute	Records the MoML parser used.

Table 7.1: Names of special attributes

name	class	use
_url	ptolemy.moml.URLAttribute	Identifies the URL for the model definition.
_vergilLocation	ptolemy.actor.gui.LocationAttribute	Location of the vergil window.
_vergilSize	ptolemy.actor.gui.SizeAttribute	Size of the graph pane in the vergil window.

7.3.5 List Classes

Figure 7.3 shows two list classes that are used extensively in Ptolemy II. `NamedList` implements an ordered list of objects with the `Nameable` interface. It is unlike a hash table in that it maintains an ordering of the entries that is independent of their names. It is unlike a vector or a linked list in that it supports accesses by name. It is used in figure 7.3 to maintain a list of attributes, and in figure 7.2 to maintain the list of ports contained by an entity.

The class `CrossRefList` is a bit more interesting. It mediates bidirectional links between objects that contain `CrossRefLists`, in this case, ports and relations. It provides a simple and efficient mechanism for constructing a web of objects, where each object maintains a list of the objects it is linked to. That list is an instance of `CrossRefList`. The class ensures consistency. That is, if one object in the web is linked to another, then the other is linked back to the one. `CrossRefList` also handles efficient modification of the cross references. In particular, if a link is removed from the list maintained by one object, the back reference in the remote object also has to be deleted. This is done in $O(1)$ time. A more brute force solution would require searching the remote list for the back reference, increasing the time required and making it proportional to the number of links maintained by each object.

7.4 Clustered Graphs

The classes shown in figure 7.2 provide only partial support for hierarchy, through the concept of a container. Subclasses, shown in figure 7.4, extend these with more complete support for hierarchy. `ComponentEntity`, `ComponentPort`, and `ComponentRelation` are used whenever a clustered graph is used. All ports of a `ComponentEntity` are required to be instances of `ComponentPort`. `CompositeEntity` extends `ComponentEntity` with the capability of containing `ComponentEntity` and `ComponentRelation` objects. Thus, it contains a subgraph. The association between `ComponentEntity` and `CompositeEntity` is the classic Composite design pattern [28].

7.4.1 Abstraction

Composite entities are non-atomic (`isAtomic()` return false). They can contain a graph (entities and relations). By default, a `CompositeEntity` is transparent (`isOpaque()` returns false). Conceptually, this means that its contents are visible from the outside. The hierarchy can be ignored (flattened) by algorithms operating on the topology. Some subclasses of `CompositeEntity` are opaque (see the Actor Package chapter for examples). This forces algorithms to respect the hierarchy, effectively hiding the contents of a composite and making it appear indistinguishable from atomic entities.

A `ComponentPort` contained by a `CompositeEntity` has inside as well as outside links. It maintains two lists of links, those to relations inside and those to relations outside. Such a port serves to expose ports in the contained entities as ports of the composite. This is the converse of the “hiding” operator often found in process algebras [64]. Ports within an entity are hidden by default, and must be explic-

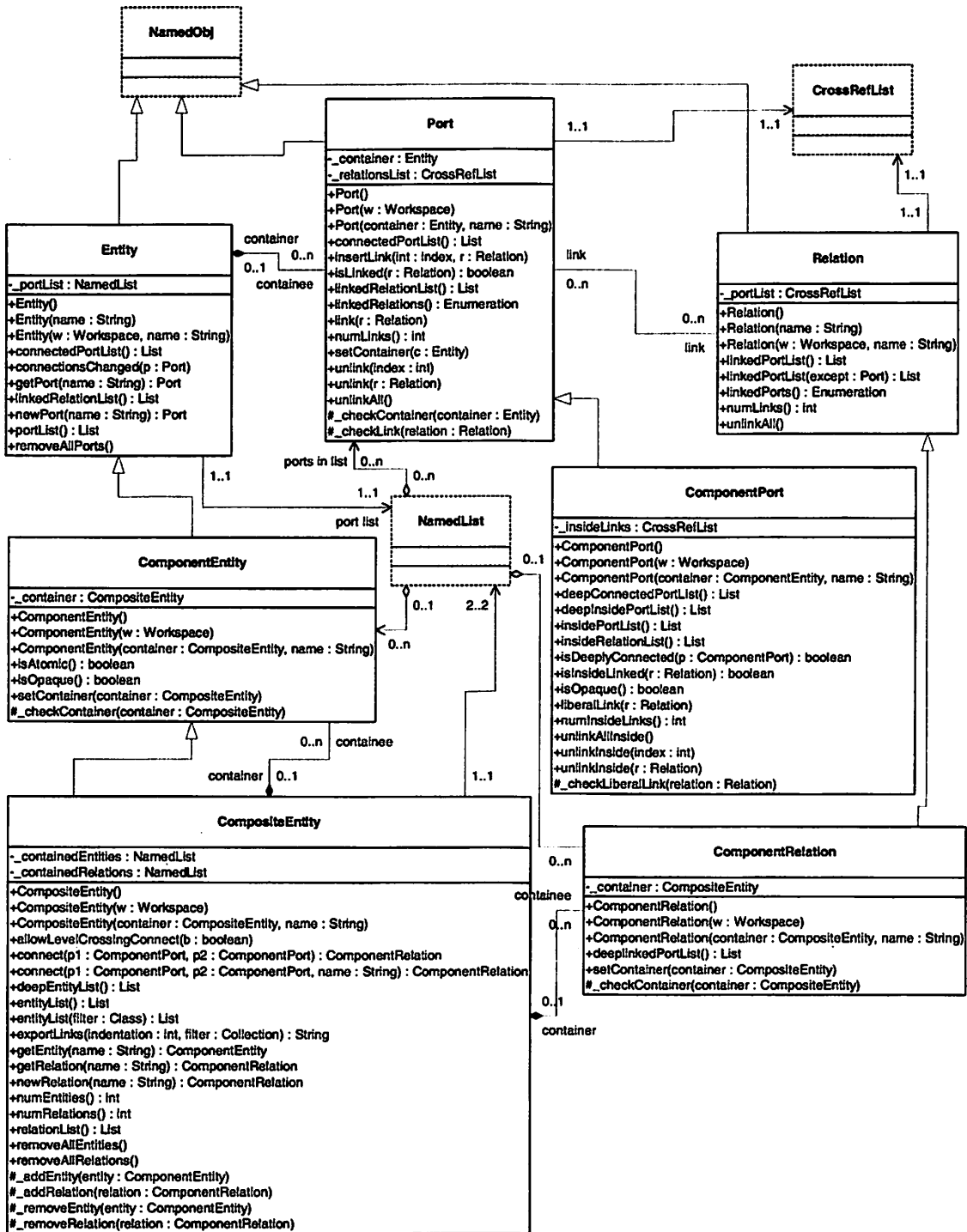

FIGURE 7.4. Key classes supporting clustered graphs.

itly exposed to be visible (linkable) from outside the entity¹. The composite entity with ports thus provides an abstraction of the contents of the composite.

A port of a composite entity may be opaque or transparent. It is defined to be *opaque* if its container is opaque. Conceptually, if it is opaque, then its inside links are not visible from the outside, and the outside links are not visible from the inside. If it is opaque, it appears from the outside to be indistinguishable from a port of an atomic entity.

The transparent port mechanism is illustrated by the example in figure 7.5². Some of the ports in figure 7.5 are filled in white rather than black. These ports are said to be *transparent*. Transparent ports (P3 and P4) are linked to relations (R1 and R2) below their container (E1) in the hierarchy. They may also be linked to relations at the same level (R3 and R4).

ComponentPort, ComponentRelation, and CompositeEntity have a set of methods with the prefix “deep,” as shown in figure 7.4. These methods flatten the hierarchy by traversing it. Thus, for example, the ports that are “deeply” connected to port P1 in figure 7.5 are P2, P5, and P6. No transparent port is included, so note that P3 is not included.

Deep traversals of a graph follow a simple rule. If a transparent port is encountered from inside, then the traversal continues with its outside links. If it is encountered from outside, then the traversal continues with its inside links. Thus, for example, the ports deeply connected to P5 are P1 and P2. Note that P6 is not included. Similarly, the deepEntityList() method of CompositeEntity looks inside transparent entities, but not inside opaque entities.

Since deep traversals are more expensive than just checking adjacent objects, both ComponentPort and ComponentRelation cache them. To determine the validity of the cached list, the version of the workspace is used. As shown in figure 7.2, the Workspace class includes a getVersion() and incrVersion() method. All methods of objects within a workspace that modify the topology in any way are expected to increment the version count of the workspace. That way, when a deep access is performed

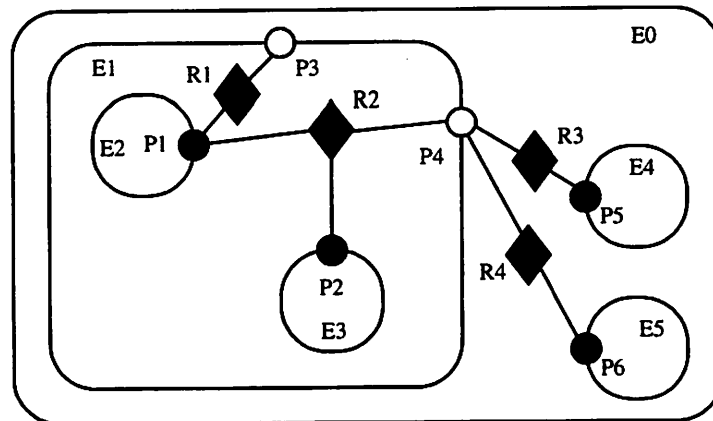

FIGURE 7.5. Transparent ports (P3 and P4) are linked to relations (R1 and R2) below their container (E1) in the hierarchy. They may also be linked to relations at the same level (R3 and R4).

1. Unless level-crossing links are allowed, which is discouraged.
2. In that figure, every object has been given a unique name. This is not necessary since names only need to be unique within a container. In this case, we could refer to P5 by its full name .E0.E4.P5 (the leading period indicates that this name is absolute). However, using unique names makes our explanations more readable.

by a `ComponentPort`, it can locally store the resulting list and the current version of the workspace. The next time the deep access is requested, it checks the version of the workspace. If it is still the same, then it returns the locally cached list. Otherwise, it reconstructs it.

For `ComponentPort` to support both inside links and outside links, it has to override the `link()` and `unlink()` methods. Given a relation as an argument, these methods can determine whether a link is an inside link or an outside link by checking the container of the relation. If that container is also the container of the port, then the link is an inside link.

7.4.2 Level-Crossing Connections

For a few applications, such as Statecharts [34], level-crossing links and connections are needed. The example shown in figure 7.6 has three level-crossing connections that are slightly different from one another. The links in these connections are created using the `liberalLink()` method of `ComponentPort`. The `link()` method prohibits such links, throwing an exception if they are attempted (most applications will prohibit level-crossing connections by using only the `link()` method).

An alternative that may be more convenient for a user interface is to use the `connect()` methods of `CompositeEntity` rather than the `link()` or `liberalLink()` method of `ComponentPort`. To allow level-crossing links using `connect()`, first call `allowLevelCrossingConnect()` with a `true` argument.

The simplest level-crossing connection in figure 7.6 is at the bottom, connecting P2 to P7 via the relation R5. The relation is contained by E1, but the connection would be essentially identical if it were contained by any other entity. Thus, the notion of composite entities containing relations is somewhat weaker when level-crossing connections are allowed.

The other two level-crossing connections in figure 7.6 are mediated by transparent ports. This sort

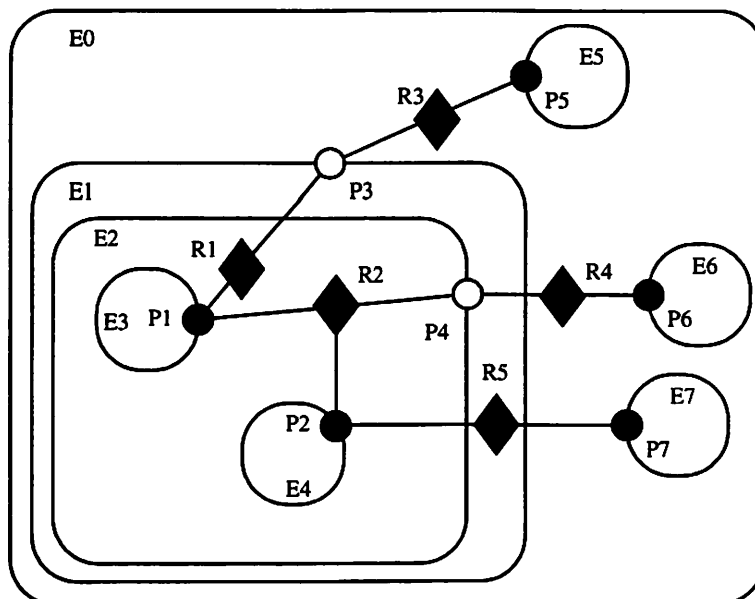

FIGURE 7.6. An example with level-crossing transitions.

of hybrid could come about in heterogeneous representations, where level-crossing connections are permitted in some parts but not in others. It is important, therefore, for the classes to support such hybrids.

To support such hybrids, we have to modify slightly the algorithm by which a port recognizes an inside link. Given a relation and a port, the link is an inside link if the relation is contained by an entity that is either the same as or is deeply contained (i.e. directly or indirectly contained) by the entity that contains the port. The `deepContains()` method of `NamedObj` supports this test.

7.4.3 Tunneling Entities

The transparent port mechanism we have described supports connections like that between P1 and P5 in figure 7.7. That connection passes through the entity E2. The relation R2 is linked to the inside of each of P2 and P4, in addition to its link to the outside of P3. Thus, the ports deeply connected to P1 are P3 and P5, and those deeply connected to P3 are P1 and P5, and those deeply connected to P5 are P1 and P3.

A *tunneling entity* is one that contains a relation with links to the inside of more than one port. It may of course also contain more standard links, but the term “tunneling” suggests that at least some deep graph traversals will see right through it.

Support for tunneling entities is a major increment in capability over the previous Ptolemy kernel [14] (Ptolemy Classic). That infrastructure required an entity (which was called a *star*) to intervene in any connection through a composite entity (which was called a *galaxy*). Two significant limitations resulted. The first was that compositionality was compromised. A connection could not be subsumed into a composite entity without fundamentally changing the structure of the application (by introducing a new intervening entity). The second was that implementation of higher-order functions that mutated the graph [54] was made much more complicated. These higher-order functions had to be careful to avoid mutations that created tunneling.

7.4.4 Cloning

The kernel classes are all capable of being *cloned*, with some restrictions. Cloning means that an identical but entirely independent object is created. Thus, if the object being cloned contains other objects, then those objects are also cloned. If those objects are linked, then the links are replicated in the new objects. The `clone()` method in `NamedObj` provides the interface for doing this. Each subclass provides an implementation.

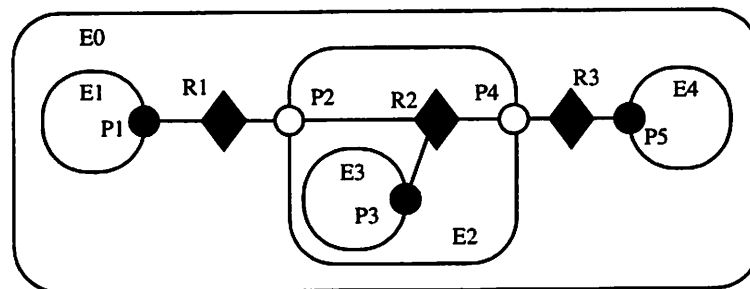

FIGURE 7.7. A tunneling entity contains a relation with inside links to more than one port.

There is a key restriction to cloning. Because they break modularity, level-crossing links prevent cloning. With level-crossing links, a link does not clearly belong to any particular entity. An attempt to clone a composite that contains level-crossing links will trigger an exception.

7.4.5 An Elaborate Example

An elaborate example of a clustered graph is shown in figure 7.8. This example includes instances of all the capabilities we have discussed. The top-level entity is named "E0." All other entities in this example have containers. A Java class that implements this example is shown in figure 7.9. A script in the Tcl language [73] that constructs the same graph is shown in figure 7.10. This script uses Tcl Blend, an interface between Tcl and Java that is distributed by Scriptics.

The order in which links are constructed matters, in the sense that methods that return lists of objects preserve this order. The order implemented in both figures 7.9 and 7.10 is top-to-bottom and left-to-right in figure 7.8. A graphical syntax, however, does not generally have a particularly convenient way to completely control this order.

The results of various method accesses on the graph are shown in figure 7.11. This table can be studied to better understand the precise meaning of each of the methods.

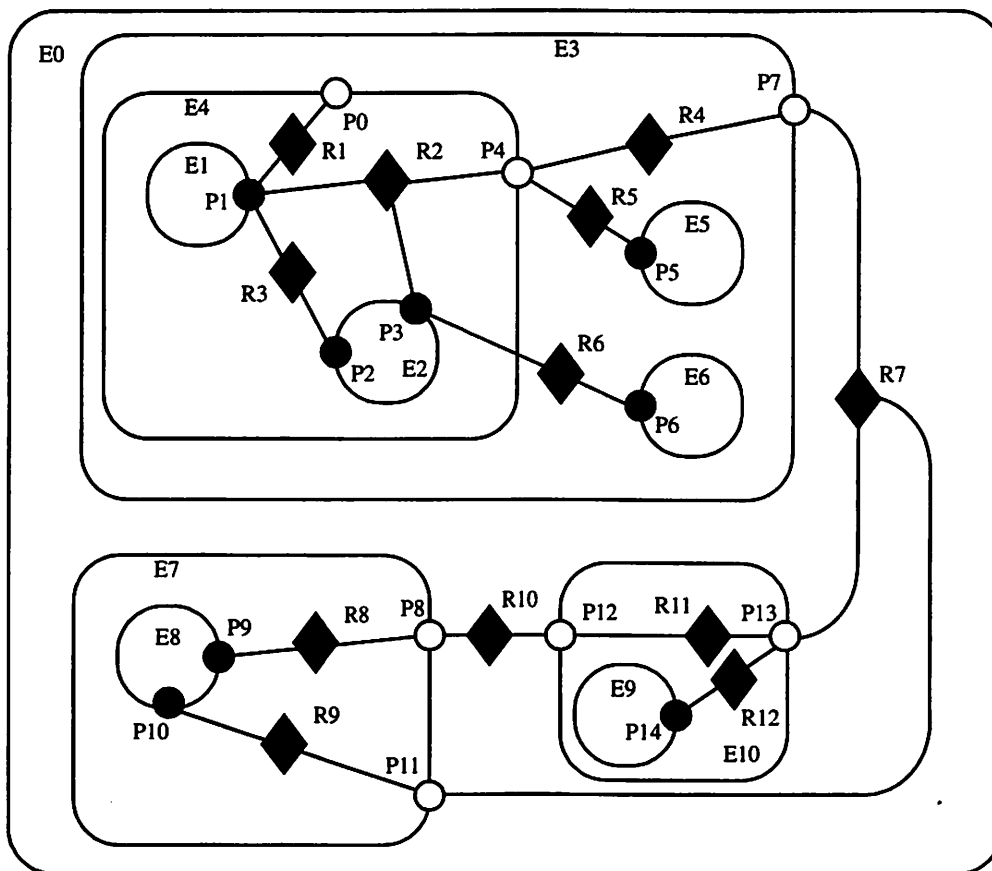

FIGURE 7.8. An example of a clustered graph.

```

public class ExampleSystem {
    private CompositeEntity e0, e3, e4, e7, e10;
    private ComponentEntity e1, e2, e5, e6, e8, e9;
    private ComponentPort p0, p1, p2, p3, p4, p5, p6, p7, p8, p9, p10, p11, p12, p13, p14;
    private ComponentRelation r1, r2, r3, r4, r5, r6, r7, r8, r9, r10, r11, r12;

    public ExampleSystem() throws IllegalArgumentException, NameDuplicationException {
        e0 = new CompositeEntity();
        e0.setName("E0");
        e3 = new CompositeEntity(e0, "E3");
        e4 = new CompositeEntity(e3, "E4");
        e7 = new CompositeEntity(e0, "E7");
        e10 = new CompositeEntity(e0, "E10");

        e1 = new ComponentEntity(e4, "E1");
        e2 = new ComponentEntity(e4, "E2");
        e5 = new ComponentEntity(e3, "E5");
        e6 = new ComponentEntity(e3, "E6");
        e8 = new ComponentEntity(e7, "E8");
        e9 = new ComponentEntity(e10, "E9");

        p0 = (ComponentPort) e4.newPort("P0");
        p1 = (ComponentPort) e1.newPort("P1");
        p2 = (ComponentPort) e2.newPort("P2");
        p3 = (ComponentPort) e2.newPort("P3");
        p4 = (ComponentPort) e4.newPort("P4");
        p5 = (ComponentPort) e5.newPort("P5");
        p6 = (ComponentPort) e5.newPort("P6");
        p7 = (ComponentPort) e3.newPort("P7");
        p8 = (ComponentPort) e7.newPort("P8");
        p9 = (ComponentPort) e8.newPort("P9");
        p10 = (ComponentPort) e8.newPort("P10");
        p11 = (ComponentPort) e7.newPort("P11");
        p12 = (ComponentPort) e10.newPort("P12");
        p13 = (ComponentPort) e10.newPort("P13");
        p14 = (ComponentPort) e9.newPort("P14");

        r1 = e4.connect(p1, p0, "R1");
        r2 = e4.connect(p1, p4, "R2");
        p3.link(r2);
        r3 = e4.connect(p1, p2, "R3");
        r4 = e3.connect(p4, p7, "R4");
        r5 = e3.connect(p4, p5, "R5");
        e3.allowLevelCrossingConnect(true);
        r6 = e3.connect(p3, p6, "R6");
        r7 = e0.connect(p7, p13, "R7");
        r8 = e7.connect(p9, p8, "R8");
        r9 = e7.connect(p10, p11, "R9");
        r10 = e0.connect(p8, p12, "R10");
        r11 = e10.connect(p12, p13, "R11");
        r12 = e10.connect(p14, p13, "R12");
        p11.link(r7);
    }
}

```

FIGURE 7.9. The same topology as in figure 7.8 implemented as a Java class.

7.5 Opaque Composite Entities

One of the major tenets of the Ptolemy project is that of modeling heterogeneous systems through the use of hierarchical heterogeneity. Information-hiding is a central part of this. In particular, transparent ports and entities compromise information hiding by exposing the internal topology of an entity. In some circumstances, this is inappropriate, for example when the entity internally operates under a different model of computation from its environment. The entity should be opaque in this case.

An entity can be opaque and composite at the same time. Ports are defined to be opaque if the entity containing them is opaque (`isOpaque()` returns true), so deep traversals of the topology do not cross these ports, even though the ports support inside and outside links. The actor package makes

```
# Create composite entities
set e0 [java::new pt.kernel.CompositeEntity E0]
set e3 [java::new pt.kernel.CompositeEntity $e0 E3]
set e4 [java::new pt.kernel.CompositeEntity $e3 E4]
set e7 [java::new pt.kernel.CompositeEntity $e0 E7]
set e10 [java::new pt.kernel.CompositeEntity $e0 E10]

# Create component entities.
set e1 [java::new pt.kernel.ComponentEntity $e4 E1]
set e2 [java::new pt.kernel.ComponentEntity $e4 E2]
set e5 [java::new pt.kernel.ComponentEntity $e3 E5]
set e6 [java::new pt.kernel.ComponentEntity $e3 E6]
set e8 [java::new pt.kernel.ComponentEntity $e7 E8]
set e9 [java::new pt.kernel.ComponentEntity $e10 E9]

# Create ports.
set p0 [$e4 newPort P0]
set p1 [$e1 newPort P1]
set p2 [$e2 newPort P2]
set p3 [$e2 newPort P3]
set p4 [$e4 newPort P4]
set p5 [$e5 newPort P5]
set p6 [$e6 newPort P6]
set p7 [$e3 newPort P7]
set p8 [$e7 newPort P8]
set p9 [$e8 newPort P9]
set p10 [$e8 newPort P10]
set p11 [$e7 newPort P11]
set p12 [$e10 newPort P12]
set p13 [$e10 newPort P13]
set p14 [$e9 newPort P14]

# Create links
set r1 [$e4 connect $p1 $p0 R1]
set r2 [$e4 connect $p1 $p4 R2]
$e3 link $r2
set r3 [$e4 connect $p1 $p2 R3]
set r4 [$e3 connect $p4 $p7 R4]
set r5 [$e3 connect $p4 $p5 R5]
$e3 allowLevelCrossingConnect true
set r6 [$e3 connect $p3 $p6 R6]
set r7 [$e0 connect $p7 $p13 R7]
set r8 [$e7 connect $p9 $p8 R8]
set r9 [$e7 connect $p10 $p11 R9]
set r10 [$e0 connect $p8 $p12 R10]
set r11 [$e10 connect $p12 $p13 R11]
set r12 [$e10 connect $p14 $p13 R12]
$p11 link $r7
```

FIGURE 7.10. The same topology as in figure 7.8 described by the Tcl Blend commands to create it.

extensive use of such entities to support mixed modeling. That use is described in the Actor Package chapter. In the previous generation system, Ptolemy Classic, composite opaque entities were called *wormholes*.

7.6 Concurrency

We expect concurrency. Topologies often represent the structure of computations. Those computations themselves may be concurrent, and a user interface may be interacting with the topologies while they execute their computation. Moreover, Ptolemy II objects may interact with other objects concurrently over the network via RMI or CORBA.

Both computations within an entity and the user interface are capable of modifying the topology. Thus, extra care is needed to make sure that the topology remains consistent in the face of simultaneous modifications (we defined consistency in section 7.2.2).

Concurrency could easily corrupt a topology if a modification to a symmetric pair of references is interrupted by another thread that also tries to modify the pair. Inconsistency could result if, for example, one thread sets the reference to the container of an object while another thread adds the same object to a different container's list of contained objects. Ptolemy II prevents such inconsistencies from occurring. Such enforced consistency is called *thread safety*.

Table 7.1: Methods of ComponentRelation

Method Name	R1	R2	R3	R4	R5	R6	R7	R8	R9	R10	R11	R12
getLinkedPorts	P1 P0	P1 P4 P3	P1 P2	P4 P7	P4 P5	P3 P6	P7 P13 P11	P9 P8	P10 P11	P8 P12	P12 P13	P14 P13
deepGetLinkedPorts	P1	P1 P9 P14 P10 P5 P3	P1 P2	P1 P3 P9 P14 P10	P1 P3 P5	P3 P6	P1 P3 P9 P14 P10	P9 P1 P3 P10	P10 P1 P3 P9 P14	P9 P1 P3 P10	P9 P1 P3 P10	P14 P1 P3 P10

Table 7.2: Methods of ComponentPort

Method Name	P0	P1	P2	P3	P4	P5	P6	P7	P8	P9	P10	P11	P12	P13	P14
getConnectedPorts		P0 P4 P3 P2	P1	P1 P4 P6	P7 P5	P4	P3	P13 P11	P12	P8	P11	P7 P13	P8	P7 P11	P13
deepGetConnectedPorts		P9 P14 P10 P5 P3 P2	P1	P1 P9 P14 P10 P5 P6	P9 P14 P10 P5	P1 P3	P3	P9 P14 P10	P1 P3 P10	P1 P3 P9 P14	P1 P3 P9 P14	P1 P3 P9 P14	P9	P1 P3 P10	P1 P3 P10

FIGURE 7.11. Key methods applied to figure 7.8.

7.6.1 Limitations of Monitors

Java threads provide a low-level mechanism called a *monitor* for controlling concurrent access to data structures. A monitor locks an object preventing other threads from accessing the object (a design pattern called *mutual exclusion*). Unfortunately, the mechanism is fairly tricky to use correctly. It is non-trivial to avoid deadlock and race conditions. One of the major objectives of Ptolemy II is provide higher-level concurrency models that can be used with confidence by non experts.

Monitors are invoked in Java via the “synchronized” keyword. This keyword annotates a body of code or a method, as shown in figure 7.12. It indicates that an exclusive lock should be obtained on a specific object before executing the body of code. If the keyword annotates a method, as in figure 7.12(a), then the method’s object is locked (an instance of class A in the figure). The keyword can also be associated with an arbitrary body of code and can acquire a lock on an arbitrary object. In figure 7.12(b), the code body represented by ellipses (...) can be executed only after a lock has been acquired on object *obj*.

Modifications to a topology that run the risk of corrupting the consistency of the topology involve more than one object. Java does not directly provide any mechanism for simultaneously acquiring a lock on multiple objects. Acquiring the locks sequentially is not good enough because it introduces deadlock potential. I.e., one thread could acquire the lock on the first object block trying to acquire a lock on the second, while a second thread acquires a lock on the second object and blocks trying to acquire a lock on the first. Both methods block permanently, and the application is deadlocked. Neither thread can proceed.

One possible solution is to ensure that locks are always acquired in the same order [47]. For exam-

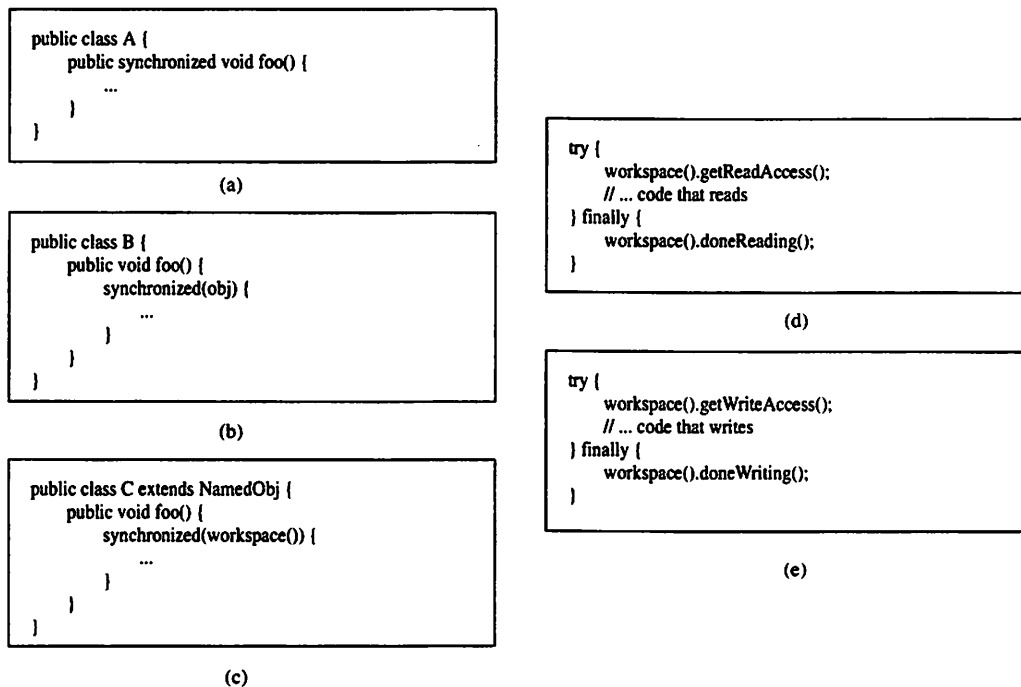

FIGURE 7.12. Using monitors for thread safety. The method used in Ptolemy II is in (d) and (e).

ple, we could use the containment hierarchy and always acquire locks top-down in the hierarchy. Suppose for example that a body of code involves two objects *a* and *b*, where *a* contains *b* (directly or indirectly). In this case, “involved” means that it either modifies members of the objects or depends on their values. Then this body of code would be surrounded by:

```
synchronized(a) {  
    synchronized (b) {  
        ...  
    }  
}
```

If all code that locks *a* and *b* respects this same order, then deadlock cannot occur. However, if the code involves two objects where one does not contain the other, then it is not obvious what ordering to use in acquiring the locks. Worse, a change might be initiated that reverses the containment hierarchy while another thread is in the process of acquiring locks on it. A lock must be acquired to read the containment structure before the containment structure can be used to acquire a lock! Some policy could certainly be defined, but the resulting code would be difficult to guarantee. Moreover, testing for deadlock conditions is notoriously difficult, so we implement a more conservative, and much simpler strategy.

7.6.2 Read and Write Access Permissions for Workspace

One way to guarantee thread safety without introducing the risk of deadlock is to give every object an immutable association with another object, which we call its *workspace*. *Immutable* means that the association is set up when the object is constructed, and then cannot be modified. When a change involves multiple objects, those objects must be associated with the same workspace. We can then acquire a lock on the workspace before making any changes or reading any state, preventing other threads from making changes at the same time.

Ptolemy II uses monitors only on instances of the class *Workspace*. As shown in figure 7.3, every instance of *NamedObj* (or derived classes) is associated with a single instance of *Workspace*. Each body of code that alters or depends on the topology must acquire a lock on its workspace. Moreover, the workspace associated with an object is immutable. It is set in the constructor and never modified. This is enforced by a very simple mechanism: a reference to the workspace is stored in a private variable of the base class *NamedObj*, as shown in figure 7.3, and no methods are provided to modify it. Moreover, in instances of these kernel classes, a container and its containees must share the same workspace (derived classes may be more liberal in certain circumstances). This “managed ownership” [47] is our central strategy in thread safety.

As shown in figure 7.12(c), a conservative approach would be to acquire a monitor on the workspace for each body of code that reads or modified objects in the workspace. However, this approach is too conservative. Instead, Ptolemy II allows any number of readers to simultaneously access a workspace. Only one writer can access the workspace, however, and only if no readers are concurrently accessing the workspace.

The code for readers and writers is shown in figure 7.12(d) and (e). In (d), a reader first calls the `getReadAccess()` method of the *Workspace* class. That method does not return until it is safe to read data anywhere in the workspace. It is safe if there is no other thread concurrently holding (or requesting) a write lock on the workspace (the thread calling `getReadAccess()` may safely hold both a read and a write lock). When the user is finished reading the workspace data, it must call `doneReading()`.

Failure to do so will result in no writer ever again gaining write access to the workspace. Because it is so important to call this method, it is enclosed in the finally clause of a try statement. That clause is executed even if an exception occurs in the body of the try statement.

The code for writers is shown in figure 7.12(e). The writer first calls the `getWriteAccess()` method of the `Workspace` class. That method does not return until it is safe to write into the workspace. It is safe if no other thread has read or write permission on the workspace. The calling thread, of course, may safely have both read and write permission at the same time. Once again, it is essential that `doneWriting()` be called after writing is complete.

This solution, while not as conservative as the single monitor of figure 7.12(c), is still conservative in that mutual exclusion is applied even on write actions that are independent of one another if they share the same workspace. This effectively serializes some modifications that might otherwise occur in parallel. However, there is no constraint in Ptolemy II on the number of workspaces used, so subclasses of these kernel classes could judiciously use additional workspaces to increase the parallelism. But they must do so carefully to avoid deadlock. Moreover, most of the methods in the kernel refuse to operate on multiple objects that are not in the same workspace, throwing an exception on any attempt to do so. Thus, derived classes that are more liberal will have to implement their own mechanisms supporting interaction across workspaces.

There is one significant subtlety regarding read and write permissions on the workspace. In a multithreaded application, normally, when a thread suspends (for example by calling `wait()`), if that thread holds read permission on the workspace, that permission is not relinquished during the time the thread is suspended. If another thread requires write permission to perform whatever action the first thread is waiting for, then deadlock will ensue. That thread cannot get write access until the first thread releases its read permission, and the first thread cannot continue until the second thread gets write access.

The way to avoid this situation is to use the `wait()` method of `Workspace`, passing as an argument the object on which you wish to wait (see `Workspace` methods in figure 7.3). That method first relinquishes all read permissions before calling `wait` on the target object. When `wait()` returns, notice that it is possible that the topology has changed, so callers should be sure to re-read any topology-dependent information. In general, this technique should be used whenever a thread suspends while it holds read permissions.

7.6.3 Making a Workspace Read Only

Acquiring read and write access permissions on the workspace is not free, and it is performed so often in a typical application that it can significantly degrade performance. In some situations, an application may simply wish to prohibit all modifications to the topology for some period of time. This can be done by calling `setReadOnly()` on the workspace (see `Workspace` methods in figure 7.3). Once the workspace is read only, requests for read permission are routinely (and very quickly) granted, and requests for write permission trigger an exception. Thus, making a workspace read only can significantly improve performance, at the expense of denying changes to the topology.

7.7 Mutations

Often it is necessary to carefully constrain when changes can be made in a topology. For example, an application that uses the actor package to execute a model defined by a topology may require the topology to remain fixed during segments of the execution. During these segments, the workspace can be made read-only (see section 7.6.3), significantly improving performance.

The util subpackage of the kernel package provides support for carefully controlled mutations that can occur during the execution of a model. The relevant classes and interfaces are shown in figure 7.13. Also shown in the figure is the most useful mutation class, MoMLChangeRequest, which uses MoML to specify the mutation. That class is in the moml package.

The usage pattern involves a source that wishes to have a mutation performed, such as an actor (see the Actor Package chapter) or a user interface component. The originator creates an instance of the class ChangeRequest and enqueues that request by calling the requestChange() of any object in the Ptolemy II hierarchy. That object typically delegates the request to the top-level of the hierarchy, which in turn delegates to the manager. When it is safe, the manager executes the change by calling execute() on each enqueued ChangeRequest. In addition, it informs any registered change listeners of the mutations so that they can react accordingly. Their changeExecuted() method is called if the change succeeds, and their changeFailed() method is called if the change fails. The list of listeners is maintained

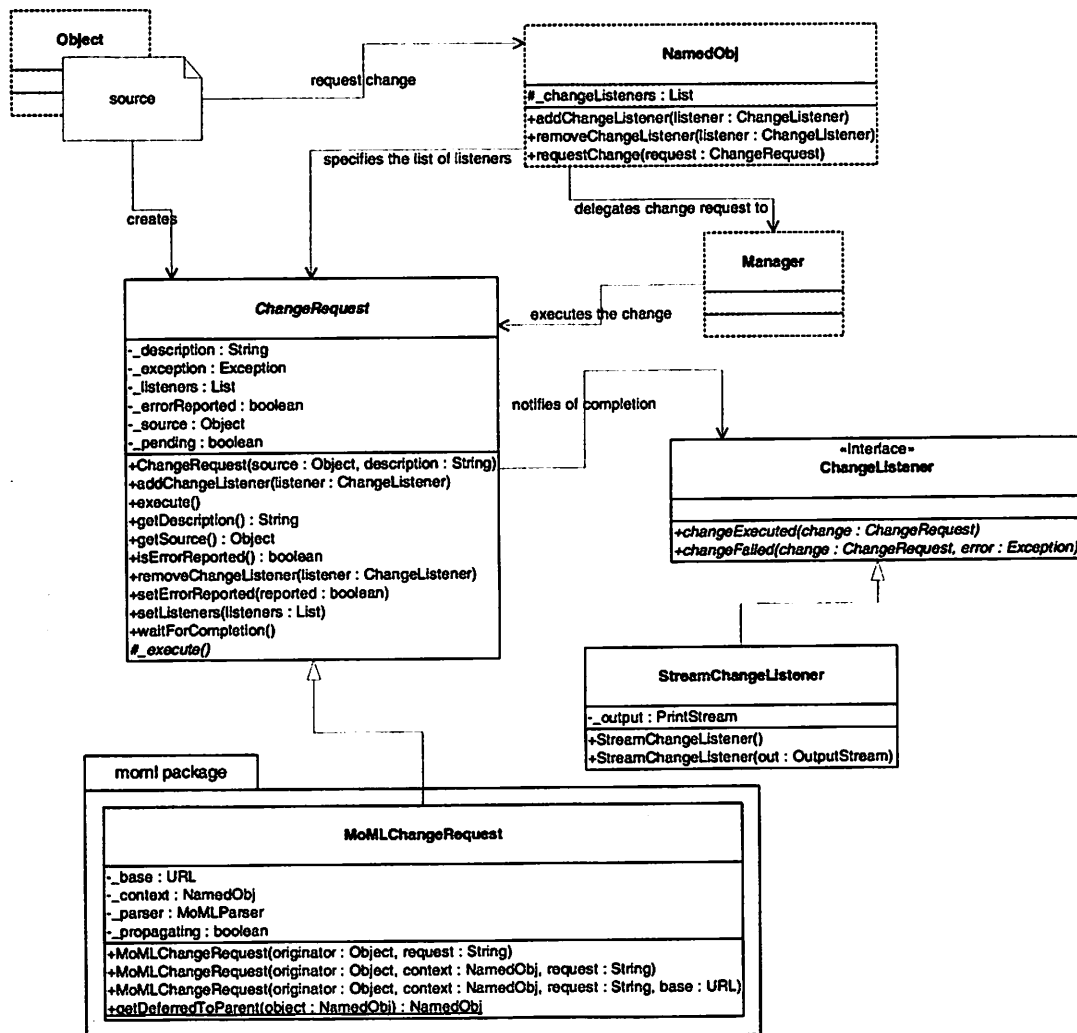

FIGURE 7.13. Classes and interfaces that support controlled topology mutations. A source requests topology changes and a manager performs them at a safe time.

by the manager, so when a listener is added to or removed from any object in the hierarchy, that request is delegated to the manager.

7.7.1 Change Requests

A manager processes a change request by calling its `execute()` method. That method then calls the protected `_execute()` method, which actually performs the change. If the `_execute()` method completes successfully, then the `ChangeRequest` object notifies listeners of success. If the `_execute()` method throws an exception, then the `ChangeRequest` object notifies listeners of failure.

The `ChangeRequest` class is abstract. Its `_execute()` method is undefined. In a typical use, an originator will define an anonymous inner class, like this:

```
CompositeEntity container = ... ;
ChangeRequest change = new ChangeRequest(originator, "description") {
    protected void _execute() throws Exception {
        ... perform change here ...
    }
};
container.requestChange(change);
```

By convention, the change request is usually posted with the container that will be affected by the change. The body of the `_execute()` method can create entities, relations, ports, links, etc. For example, the code in the `_execute()` method to create and link a new entity might look like this:

```
Entity newEntity = new MyEntityClass(originator, "NewEntity");
relation.link(newEntity.port);
```

When `_execute()` is called, the entity named `newEntity` will be created, added to `originator` (which is assumed to be an instance of `CompositeEntity` here) and linked to `relation`.

A key concrete class extending `ChangeRequest` is implemented in the `moml` package, as shown in figure 7.13. The `MoMLChangeRequest` class supports specification of a change in MoML. See the MoML chapter for details about how to write MoML specifications for changes. The `context` argument to the second constructor typically gives a composite entity within which the commands should be interpreted. Thus, the same change request as above could be accomplished as follows:

```
CompositeEntity container = ... ;
String moml = "<group>"
    + "<entity name=\"\" class=\"MyEntityClass\"/>"
    + "<link port=\"portname\" relation=\"relationname\"/>"
    + "</group>";
ChangeRequest change =
    new MoMLChangeRequest(originator, container, moml);
container.requestChange(change);
```

7.7.2 NamedObj and Listeners

The `NamedObj` class provides `addChangeListener()` and `removeChangeListener()` methods, so that

interested objects can register to be notified when topology changes occur. In addition, it provides a method that originators can use to queue requests, `requestChange()`.

A change listener is any object that implements the `ChangeListener` interface, and will typically include user interfaces and visualization components. The instance of `ChangeRequest` is passed to the listener. Typically the listener will call `getOriginator()` to determine whether it is being notified of a change that it requested. This might be used for example to determine whether a requested change succeeds or fails.

The `ChangeRequest` class also provides a `waitForCompletion()` method. This method will not return until the change request completes. If the request fails with an exception, then `waitForCompletion()` will throw that exception. Note that this method can be quite dangerous to use. It will not return until the change request is processed. If for some reason change requests are not being processed (due for a example to a bug in user code in some actor), then this method will never return. If you make the mistake of calling this method from within the event thread in Java, then if it never returns, the entire user interface will freeze, no longer responding to inputs from the keyboard or mouse, nor repainting the screen. The user will have no choice but to kill the program, possibly losing his or her work.

7.8 Exceptions

Ptolemy II includes a set of exception classes that provide a uniform mechanism for reporting errors that takes advantage of the identification of named objects by full name. These exception are summarized in the class diagram in figure 7.14.

7.8.1 Base Class

KernelException. Not used directly. Provides common functionality for the kernel exceptions. In particular, it provides methods that take zero, one, or two `Nameable` objects plus an optional detail message (a `String`). The arguments provided are arranged in a default organization that is overridden in derived classes.

7.8.2 Less Severe Exceptions

These exceptions generally indicate that an operation failed to complete. These can result in a topology that is not what the caller expects, since the caller's modifications to the topology did not succeed. However, they should *never* result in an inconsistent or contradictory topology.

IllegalActionException. Thrown on an attempt to perform an action that is disallowed. For example, the action would result in an inconsistent or contradictory data structure if it were allowed to complete. E.g., attempt to set the container of an object to be another object that cannot contain it because it is of the wrong class.

NameDuplicationException. Thrown on an attempt to add a named object to a collection that requires unique names, and finding that there already is an object by that name in the collection.

NoSuchItemException. Thrown on access to an item that doesn't exist. E.g., attempt to remove a port by name and no such port exists.

7.8.3 More Severe Exceptions

The following exceptions should never trigger. If they trigger, it indicates a serious inconsistency in the topology and/or a bug in the code. At the very least, the topology being operated on should be abandoned and reconstructed from scratch. They are runtime exceptions, so they do not need to be explicitly declared to be thrown.

InvalidStateException. Some object or set of objects has a state that in theory is not permitted. E.g., a `NamedObj` has a null name. Or a topology has inconsistent or contradictory information in it, e.g. an entity contains a port that has a different entity as its container. Our design should make it impossible for this exception to ever occur, so occurrence is a bug. This exception is derived from the Java `RuntimeException`.

InternalErrorException. An unexpected error other than an inconsistent state has been encountered. Our design should make it impossible for this exception to ever occur, so occurrence is a bug. This

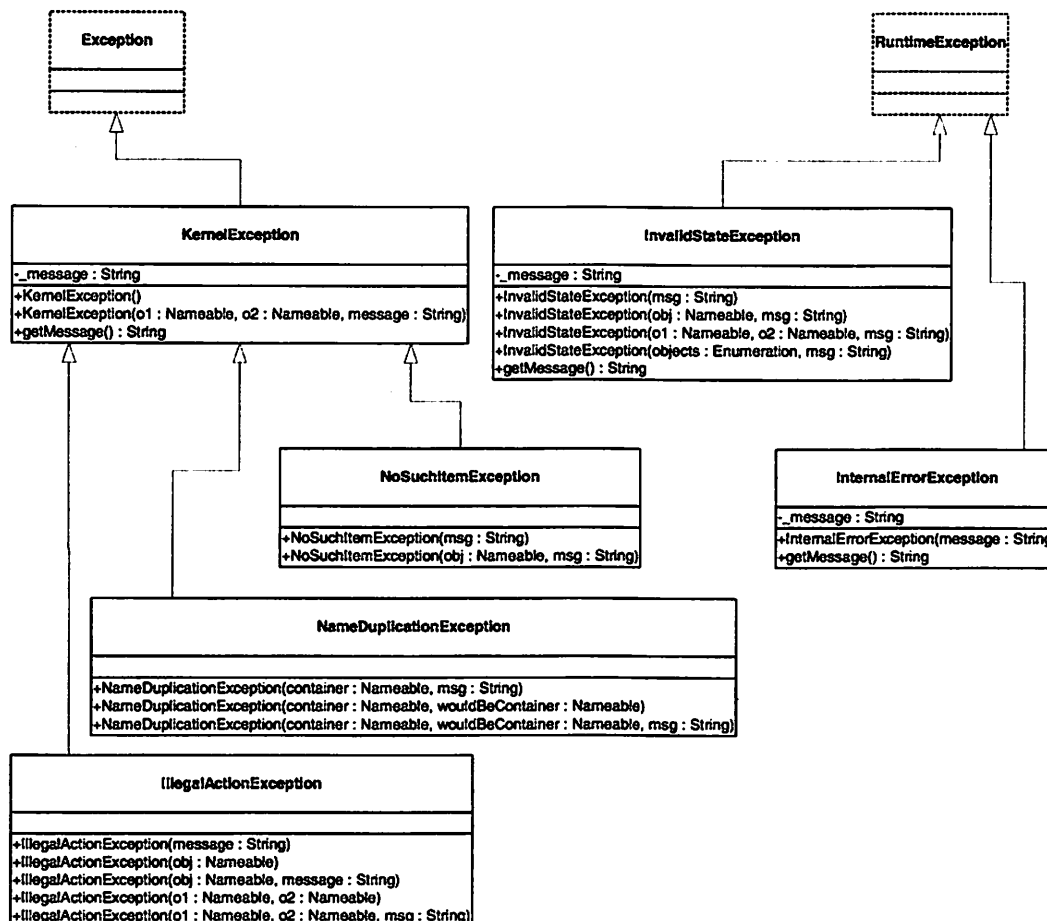

FIGURE 7.14. Summary of exceptions defined in the `kernel.util` package. These are used primarily through constructor calls. The form of the constructors is shown in the text. `Exception` and `RuntimeException` are Java exceptions.

exception is derived from the Java RuntimeException.

8

Actor Package

Author: Edward A. Lee
Contributors: Mudit Goel
Christopher Hylands
Jie Liu
Lukito Muliadi
Steve Neuendorffer
Neil Smyth
Yuhong Xiong

8.1 Concurrent Computation

In the kernel package, entities have no semantics. They are syntactic placeholders. In many of the uses of Ptolemy II, entities are executable. The actor package provides basic support for executable entities. It makes a minimal commitment to the semantics of these entities by avoiding specifying the order in which actors execute (or even whether they execute sequentially or concurrently), and by avoiding specifying the communication mechanism between actors. These properties are defined in the domains.

In most uses, these executable entities conceptually (if not actually) execute concurrently. The goal of the actor package is to provide a clean infrastructure for such concurrent execution that is neutral about the model of computation. It is intended to support dataflow, discrete-event, synchronous-reactive, continuous-time, communicating sequential processes, and process networks models of computation, at least. The detailed model of computation is then implemented in a set of derived classes called a *domain*. Each domain is a separate package.

Ptolemy II is an object-oriented application framework. *Actors* [1] extend the concept of objects to concurrent computation. Actors encapsulate a thread of control and have interfaces for interacting with

other actors. They provide a framework for “open distributed object-oriented systems.” An actor can create other actors, send messages, and modify its own local state.

Inspired by this model, we group a certain set of classes that support computation within entities in the actor package. Our use of the term “actors,” however, is somewhat broader, in that it does not require an entity to be associated with a single thread of control, nor does it require the execution of threads associated with entities to be fair. Some subclasses, in other packages, impose such requirements, as we will see, but not all.

Agha’s actors [1] can only send messages to *acquaintances* — actors whose addresses it was given at creation time, or whose addresses it has received in a message, or actors it has created. Our equivalent constraint is that an actor can only send a message to an actor if it has (or can obtain) a reference to an input port of that actor. The usual mechanism for obtaining a reference to an input port uses the topology, probing for a port that it is connected to. Our relations, therefore, provide explicit management of acquaintance associations. Derived classes may provide additional implicit mechanisms. We define *actor* more loosely to refer to an entity that processes data that it receives through its ports, or that creates and sends data to other entities through its ports.

The actor package provides templates for two key support functions. These templates support message passing and the execution sequence (flow of control). They are *templates* in that no mechanism is actually provided for message passing or flow of control, but rather base classes are defined so that domains only need to override a few methods, and so that domains can interoperate.

8.2 Message Passing

The actor package provides templates for executable entities called *actors* that communicate with one another via message passing. Messages are encapsulated in *tokens* (see the Data Package chapter). Messages are sent and received via ports. `IOPort` is the key class supporting message transport, and is shown in figure 8.2. An `IOPort` can only be connected to other `IOPort` instances, and only via `IORelations`. The `IORelation` class is also shown in figure 8.2. `TypedIOPort` and `TypedIORelation` are subclasses that manage type resolution. These subclasses are used much more often, in order to benefit from the type system. This is described in detail in the Type System chapter.

An instance of `IOPort` can be an input, an output, or both. An *input port* (one that is capable of receiving messages) contains one or more instances of objects that implement the Receiver interface. Each of these receivers is capable of receiving messages from a distinct *channel*.

The type of receiver used depends on the communication protocol, which depends on the model of computation. The actor package includes two receivers, `Mailbox` and `QueueReceiver`. These are generic enough to be useful in several domains. The `QueueReceiver` class contains a `FIFOQueue`, the capacity of which can be controlled. It also provides a mechanism for tracking the history of tokens that are received by the receiver. The `Mailbox` class implements a FIFO (first in, first out) queue with capacity equal to one.

8.2.1 Data Transport

Data transport is depicted in figure 8.1. The originating actor E1 has an output port P1, indicated in the figure with an arrow in the direction of token flow. The destination actor E2 has an input port P2, indicated in the figure with another arrow. E1 calls the `send()` method of P1 to send a token *t* to a remote actor. The port obtains a reference to a remote receiver (via the `IORelation`) and calls the `put()` method of the receiver, passing it the token. The destination actor retrieves the token by calling the

get() method of its input port, which in turn calls the get() method of the designated receiver.

Domains typically provide specialized receivers. These receivers override get() and put() to implement the communication protocol pertinent to that domain. A domain that uses asynchronous message passing, for example, can usually use the QueueReceiver shown in figure 8.2. A domain that uses synchronous message passing (rendezvous) has to provide a new receiver class.

In figure 8.1 there is only a single channel, indexed 0. The “0” argument of the send() and get() methods refer to this channel. A port can support more than one channel, however, as shown in figure 8.3. This can be represented by linking more than one relation to the port, or by linking a relation that has a width greater than one. A port that supports this is called a *multiport*. The channels are indexed 0, ..., $N - 1$, where N is the number of channels. An actor distinguishes between channels using this index in its send() and get() methods. By default, an IOPort is not a multiport, and thus supports only one channel (or zero, if it is left unconnected). It is converted into a multiport by calling its setMultiport() method with a *true* argument. After conversion, it can support any number of channels.

Multiports are typically used by actors that communicate via an indeterminate number of channels. For example, a “distributor” or “demultiplexor” actor might divide an input stream into a number of output streams, where the number of output streams depends on the connections made to the actor. A *stream* is a sequence of tokens sent over a channel.

An IORelation, by default, represents a single channel. By calling its setWidth() method, however, it can be converted to a *bus*. A multiport may use a bus instead of multiple relations to distribute its data, as shown in figure 8.4. The *width of a relation* is the number of channels supported by the relation. If the relation is not a bus, then its width is one.

The *width of a port* is the sum of the widths of the relations linked to it. In figure 8.4, both the sending and receiving ports are multiports with width two. This is indicated by the “2” adjacent to each

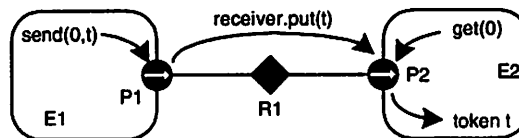

FIGURE 8.1. Message passing is mediated by the IOPort class. Its send() method obtains a reference to a remote receiver, and calls the put() method of the receiver, passing it the token t . The destination actor retrieves the token by calling the get() method of its input port.

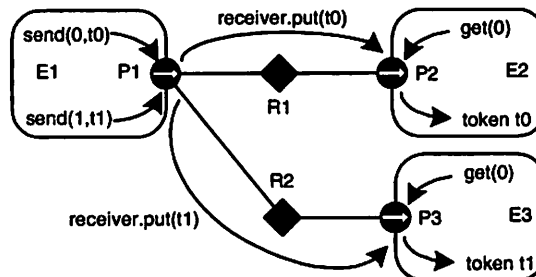

FIGURE 8.3. A port can support more than one channel, permitting an entity to send distinct data to distinct destinations via the same port. This feature is typically used when the number of destinations varies in different instances of the source actor.

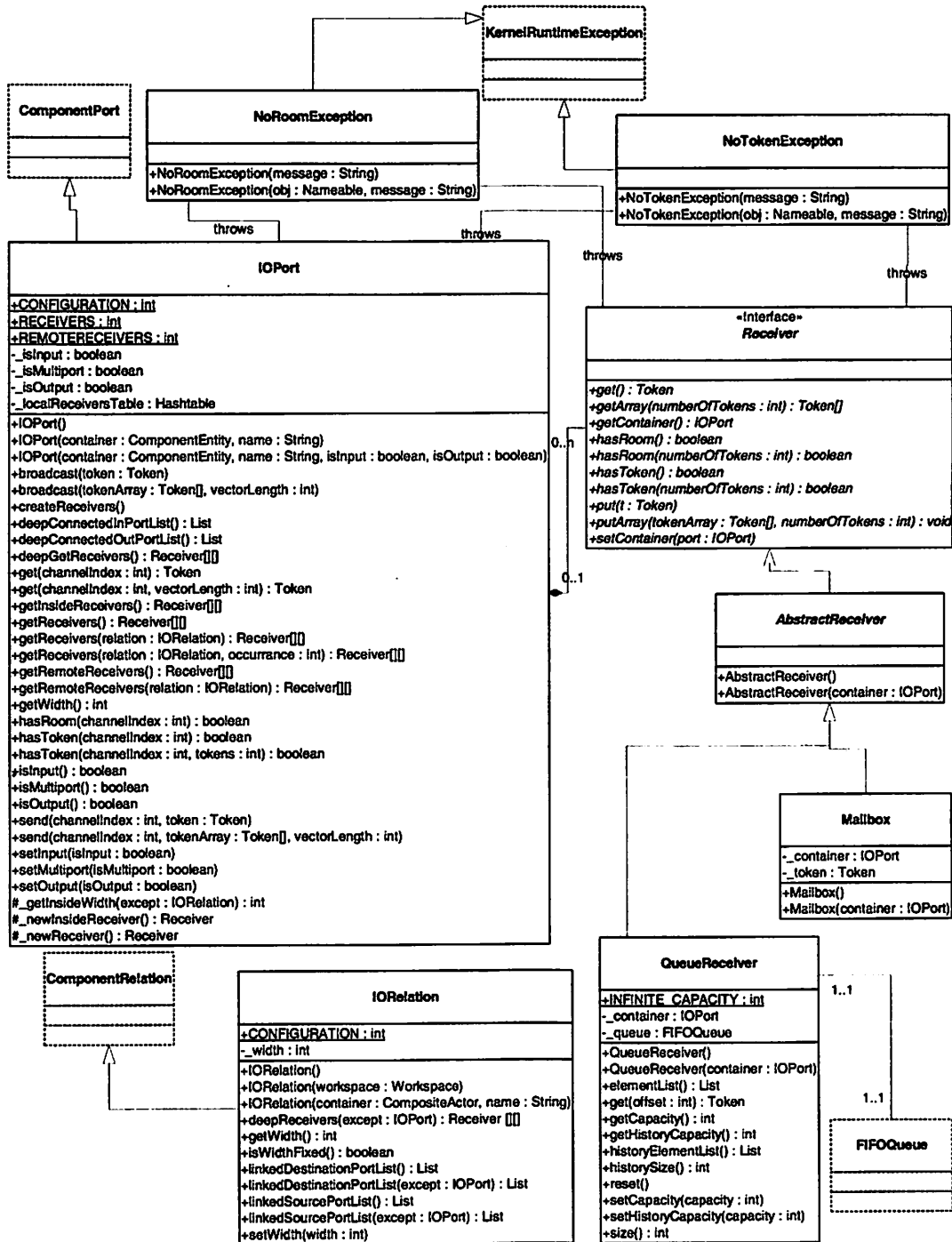

FIGURE 8.2. Port and receiver classes that provide infrastructure for message passing under various communication protocols.

port. Note that the width of a port could be zero, if there are no relations linked to a port (such a port is said to be *disconnected*). Thus, a port may have width zero, even though a relation cannot. By convention, in Ptolemy II, if a token is sent from such a port, the token goes nowhere. Similarly, if a token is sent via a relation that is not linked to any input ports, then the token goes nowhere. Such a relation is said to be *dangling*.

A given channel may reach multiple ports, as shown in figure 8.5. This is represented by a relation that is linked to multiple input ports. In the default implementation, in class IOPort, a reference to the token is sent to all destinations. Note that tokens are assumed to be immutable, so the recipients cannot modify the value. This is important because in most domains, it is not obvious in what order the recipients will see the token.

The `send()` method takes a channel number argument. If the channel does not exist, the `send()` method silently returns without sending the token anywhere. This makes it easier for model builders, since they can simply leave ports unconnected if they are not interested in the output data.

IOPort provides a `broadcast()` method for convenience. This method sends a specified token to all receivers linked to the port, regardless of the width of the port. If the width is zero, of course, the token will not be sent anywhere.

8.2.2 Example

An elaborate example showing all of the above features is shown in figure 8.6. In that example, we assume that links are constructed in top-to-bottom order. The arrows in the ports indicate the direction of the flow of tokens, and thus specify whether the port is an input, an output, or both. Multiports are indicated by adjacent numbers larger than one.

The top relation is a bus with width two, and the rest are not busses. The width of port *P1* is four.

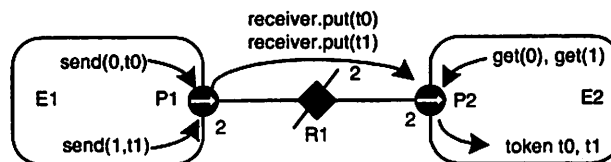

FIGURE 8.4. A bus is an IORelation that represents multiple channels. It is indicated by a relation with a slash through it, and the number adjacent to the bus is the width of the bus.

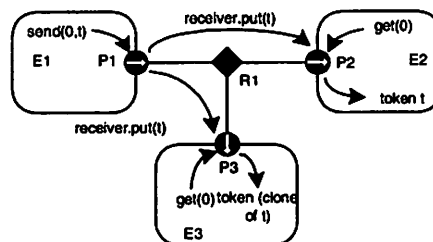

FIGURE 8.5. Channels may reach multiple destinations. This is represented by relations linking multiple input ports to an output port.

Its first two outputs (channels zero and one) go to *P4* and to the first two inputs of *P5*. The third output of *P1* goes nowhere. The fourth becomes the third input of *P5*, the first input of *P6*, and the only input of *P8*, which is both an input and an output port. Ports *P2* and *P8* send their outputs to the same set of destinations, except that *P8* does not send to itself. Port *P3* has width zero, so its `send()` method returns without sending the token anywhere. Port *P6* has width two, but its second input channel has no output ports connected to it, so calling `get(1)` will trigger an exception that indicates that there is no data. Port *P7* has width zero so calling `get()` with any argument will trigger an exception.

8.2.3 Transparent Ports

Recall that a port is transparent if its container is transparent (`isOpaque()` returns *false*). A `CompositeActor` is transparent unless it has a local director. Figure 8.7 shows an elaborate example where busses, input, and output ports are combined with transparent ports. The transparent ports are filled in white, and again arrows indicate the direction of token flow. The Jacl code to construct this example is shown in figure 8.8.

By definition, a transparent port is an input if either

- it is connected on the inside to the outside of an input port, or
- it is connected on the inside to the inside of an output port.

That is, a transparent port is an input port if it can accept data (which it may then just pass through to a transparent output port). Correspondingly, a transparent port is an output port if either

- it is connected on the inside to the outside of an output port, or
- it is connected on the inside to the inside of an input port.

Thus, assuming *P1* is an output port and *P7*, *P8*, and *P9* are input ports, then *P2*, *P3*, and *P4* are both input and output ports, while *P5* and *P6* are input ports only.

Two of the relations that are inside composite entities (*R1* and *R5*) are labeled as busses with a star (*) instead of a number. These are busses with unspecified width. The width is inferred from the topology. This is done by checking the ports that this relation is linked to from the inside and setting the width to the maximum of those port widths, minus the widths of other relations linked to those ports on

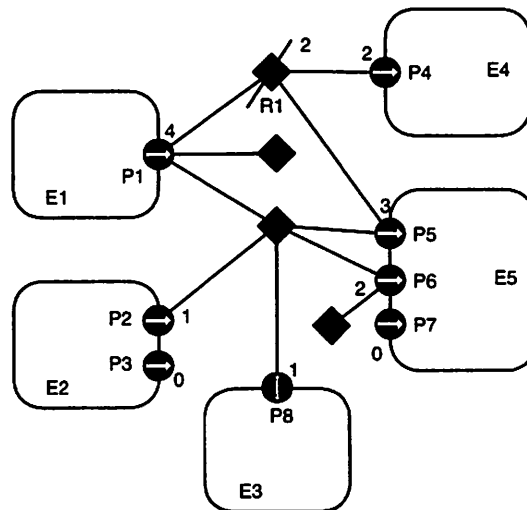

FIGURE 8.6. An elaborate example showing several features of the data transport mechanism.

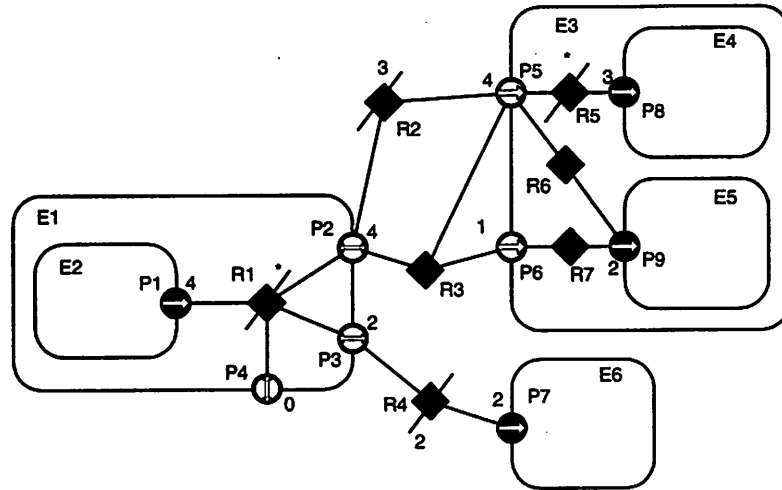

FIGURE 8.7. An example showing busses combined with input, output, and transparent ports.

<pre> set e0 [java::new ptolemy.actor.CompositeActor] \$e0 setDirector \$director \$e0 setManager \$manager set e1 [java::new ptolemy.actor.CompositeActor \$e0 E1] set e2 [java::new ptolemy.actor.AtomicActor \$e1 E2] set e3 [java::new ptolemy.actor.CompositeActor \$e0 E3] set e4 [java::new ptolemy.actor.AtomicActor \$e3 E4] set e5 [java::new ptolemy.actor.AtomicActor \$e3 E5] set e6 [java::new ptolemy.actor.AtomicActor \$e0 E6] set p1 [java::new ptolemy.actor.IOPort \$e2 P1 false true] set p2 [java::new ptolemy.actor.IOPort \$e1 P2] set p3 [java::new ptolemy.actor.IOPort \$e1 P3] set p4 [java::new ptolemy.actor.IOPort \$e1 P4] set p5 [java::new ptolemy.actor.IOPort \$e3 P5] set p6 [java::new ptolemy.actor.IOPort \$e3 P6] set p7 [java::new ptolemy.actor.IOPort \$e6 P7 true false] set p8 [java::new ptolemy.actor.IOPort \$e4 P8 true false] set p9 [java::new ptolemy.actor.IOPort \$e5 P9 true false] set r1 [java::new ptolemy.actor.IORElation \$e1 R1] set r2 [java::new ptolemy.actor.IORElation \$e0 R2] set r3 [java::new ptolemy.actor.IORElation \$e0 R3] set r4 [java::new ptolemy.actor.IORElation \$e0 R4] set r5 [java::new ptolemy.actor.IORElation \$e3 R5] set r6 [java::new ptolemy.actor.IORElation \$e3 R6] set r7 [java::new ptolemy.actor.IORElation \$e3 R7] \$sp1 setMultiport true \$sp2 setMultiport true \$sp3 setMultiport true \$sp4 setMultiport true \$sp5 setMultiport true \$sp7 setMultiport true \$sp8 setMultiport true \$sp9 setMultiport true </pre>	<pre> \$r1 setWidth 0 \$r2 setWidth 3 \$r4 setWidth 2 \$r5 setWidth 0 \$sp1 link \$r1 \$sp2 link \$r1 \$sp3 link \$r1 \$sp4 link \$r1 \$sp2 link \$r2 \$sp5 link \$r2 \$sp2 link \$r3 \$sp5 link \$r3 \$sp6 link \$r3 \$sp3 link \$r4 \$sp7 link \$r4 \$sp5 link \$r5 \$sp8 link \$r5 \$sp5 link \$r6 \$sp9 link \$r6 \$sp6 link \$r7 \$sp9 link \$r7 </pre>
--	---

FIGURE 8.8. Tcl Blend code to construct the example in figure 8.7.

the inside. Each such port is allowed to have at most one inside relation with an unspecified width, or an exception is thrown. If this inference yields a width of zero, then the width is defined to be one. Thus, R1 will have width 4 and R5 will have width 3 in this example. The width of a transparent port is the sum of the widths of the relations it is linked to on the outside (just like an ordinary port). Thus, P4 has width 0, P3 has width 2, and P2 has width 4. Recall that a port can have width 0, but a relation cannot have width less than one.

When data is sent from P1, four distinct channels can be used. All four will go through P2 and P5, the first three will reach P8, two copies of the fourth will reach P9, the first two will go through P3 to P7, and none will go through P4.

By default, an IORelation is not a bus, so its width is one. To turn it into a bus with unspecified width, call `setWidth()` with a zero argument. Note that `getWidth()` will nonetheless never return zero (it returns at least one). To find out whether `setWidth()` has been called with a zero argument, call `isWidthFixed()` (see figure 8.2). If a bus with unspecified width is not linked on the inside to any transparent ports, then its width is one. It is not allowed for a transparent port to have more than one bus with unspecified width linked on the inside (an exception will be thrown on any attempt to construct such a topology). Note further that a bus with unspecified width is still a bus, and so can only be linked to multiports.

In general, bus widths inside and outside a transparent port need not agree. For example, if $M < N$ in figure 8.9, then first M channels from P1 reach P3, and the last $N - M$ channels are dangling. If $M > N$, then all N channels from P1 reach P3, but the last $M - N$ channels at P3 are dangling. Attempting to get a token from these channels will trigger an exception. Sending a token to these channels just results in loss of the token.

Note that data is not actually transported through the relations or transparent ports in Ptolemy II. Instead, each output port caches a list of the destination receivers (in the form of the two-dimensional array returned by `getRemoteReceivers()`), and sends data directly to them. The cache is invalidated whenever the topology changes, and only at that point will the topology be traversed again. This significantly improves the efficiency of data transport.

8.2.4 Data Transfer in Various Models of Computation

The receiver used by an input port determines the communication protocol. This is closely bound to the model of computation. The IOPort class creates a new receiver when necessary by calling its `_newReceiver()` protected method. That method delegates to the director returned by `getDirector()`, calling its `newReceiver()` method (the Director class will be discussed in section 8.3 below). Thus, the director controls the communication protocol, in addition to its primary function of determining the flow of control. Here we discuss the receivers that are made available in the actor package. This should not be viewed as an exhaustive set, but rather as a particularly useful set of receivers. These receivers

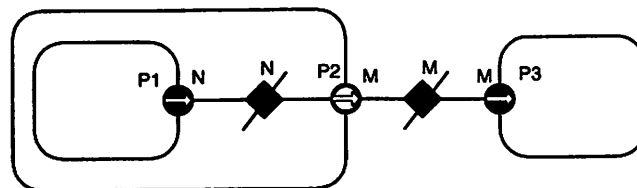

FIGURE 8.9. Bus widths inside and outside a transparent port need not agree..

are shown in figure 8.2.

Mailbox Communication. The Director base class by default returns a simple receiver called a Mailbox. A *mailbox* is a receiver that has capacity for a single token. It will throw an exception if it is empty and `get()` is called, or it is full and `put()` is called. Thus, a subclass of Director that uses this should schedule the calls to `put()` and `get()` so that these exceptions do not occur, or it should catch these exceptions.

Asynchronous Message Passing. This is supported by the QueueReceiver class. A QueueReceiver contains an instance of FIFOQueue, from the actor.util package, which implements a first-in, first-out queue. This is appropriate for all flavors of dataflow as well as Kahn process networks.

In the Kahn process networks model of computation [44], which is a generalization of dataflow [54], each actor has its own thread of execution. The thread calling `get()` will stall if the corresponding queue is empty. If the size of the queue is bounded, then the thread calling `put()` may stall if the queue is full. This mechanism supports implementation of a strategy that ensures bounded queues whenever possible [75].

In the process networks model of computation, the *history* of tokens that traverse any connection is determinate under certain simple conditions. With certain technical restrictions on the functionality of the actors (they must implement monotonic functions under prefix ordering of sequences), our implementation ensures determinacy in that the history does not depend on the order in which the actors carry out their computation. Thus, the history does not depend on the policies used by the thread scheduler.

FIFOQueue is a support class that implements a first-in, first-out queue. It is part of the actor.util package, shown in figure 8.10. This class has two specialized features that make it particularly useful in this context. First, its capacity can be constrained or unconstrained. Second, it can record a finite or infinite history, the sequence of objects previously removed from the queue. The history mechanism is useful both to support tracing and debugging and to provide access to a finite buffer of previously consumed tokens.

An example of an actor definition is shown in figure 8.11. This actor has a multiport output. It

```
public class Distributor extends TypedAtomicActor {

    public TypedIOPort _input;
    public TypedIOPort _output;

    public Distributor(CompositeActor container, String name)
        throws NameDuplicationException, IllegalActionException {
        super(container, name);
        _input = new TypedIOPort(this, "input", true, false);
        _output = new TypedIOPort(this, "output", false, true);
        _output.setMultiport(true);
    }

    public void fire() throws IllegalActionException {
        for (int i=0; i < _output.getWidth(); i++) {
            _output.send(i, _input.get(0));
        }
    }
}
```

FIGURE 8.11. An actor that distributes successive input tokens to a set of output channels.

reads successive input tokens from the input port and distributes them to the output channels. This actor is written in a domain-polymorphic way, and can operate in any of a number of domains. If it is used in the PN domain, then its input will have a QueueReceiver and the output will be connected to ports with instances QueueReceiver.

Rendezvous Communications. Rendezvous, or synchronous communication, requires that the originator of a token and the recipient of a token both be simultaneously ready for the data transfer. As with process networks, the originator and the recipient are separate threads. The originating thread indicates a willingness to rendezvous by calling send(), which in turn calls the put() method of the appropriate receiver. The recipient indicates a willingness to rendezvous by calling get() on an input port, which in turn calls get() of the designated receiver. Whichever thread does this first must stall until the other thread is ready to complete the rendezvous.

This style of communication is implemented in the CSP domain. In the receiver in that domain, the put() method suspends the calling thread if the get() method has not been called. The get() method suspends the calling thread if the put() method has not been called. When the second of these two methods is called, it wakes up the suspended thread and completes the data transfer. The actor shown in figure

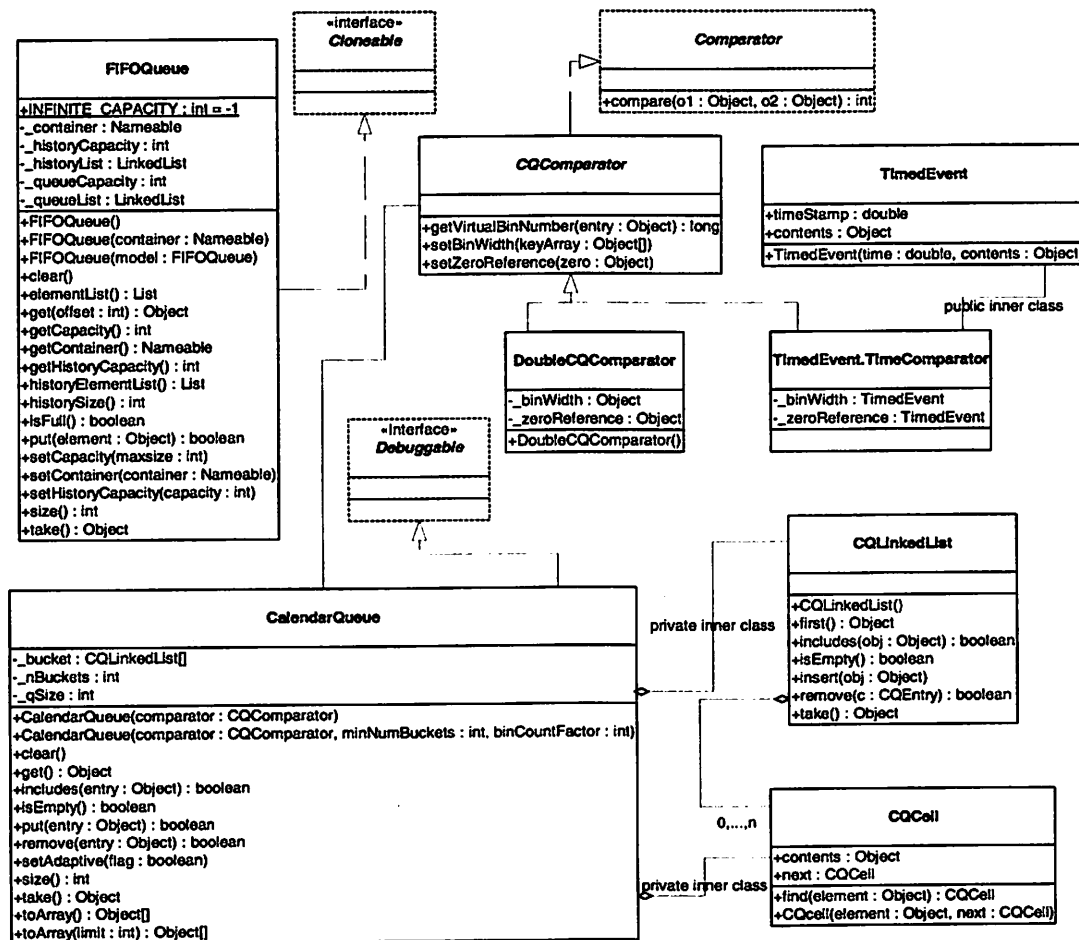

FIGURE 8.10. Static structure diagram for the actor.util package.

8.11 works unchanged in the CSP domain, although its behavior is different in that input and output actions involve rendezvous with another thread.

Nondeterministic transfers can be easily implemented using this mechanism. Suppose for example that a recipient is willing to rendezvous with any of several originating threads. It could spawn a thread for each. These threads should each call `get()`, which will suspend the thread until the originator is willing to rendezvous. When one of the originating threads is willing to rendezvous with it, it will call `put()`. The multiple recipient threads will all be awakened, but only one of them will detect that its rendezvous has been enabled. That one will complete the rendezvous, and others will die. Thus, the first originating thread to indicate willingness to rendezvous will be the one that will transfer data. Guarded communication [4] can also be implemented.

Discrete-Event Communication. In the discrete-event model of computation, tokens that are transferred between actors have a *time stamp*, which specifies the order in which tokens should be processed by the recipients. The order is chronological, by increasing time stamp. To implement this, a discrete-event system will normally use a single, global, sorted queue rather than an instance of FIFO-Queue in each input port. The `kernel.util` package, shown in figure 8.10, provides the `CalendarQueue` class, which gives an efficient and flexible implementation of such a sorted queue.

8.2.5 Discussion of the Data Transfer Mechanism

This data transfer mechanism has a number of interesting features. First, note that the actual transfer of data does not involve relations, so a model of computation could be defined that did not rely on relations. For example, a global name server might be used to address recipient ports. To construct highly dynamic networks, such as wireless communication systems, it may be more intuitive to model a system as an aggregation of unconnected actors with addresses. A name server would return a reference to a port given an address. This could be accomplished simply by overriding the `getRemoteReceivers()` method of `IOPort` or `TypedIOPort`, or by providing an alternative method for getting references to receivers. The subclass of `IOPort` would also have to ensure the creation of the appropriate number of receivers. The base class relies on the width of the port to determine how many receivers to create, and the width is zero if there are no relations linked.

Note further that the mechanism here supports bidirectional ports. An `IOPort` may return true to both the `isInput()` and `isOutput()` methods.

8.3 Execution

The `Executable` interface, shown in figure 8.12, is implemented by the `Director` class, and is extended by the `Actor` interface. An *actor* is an executable entity. There are two types of actors, `AtomicActor`, which extends `ComponentEntity`, and `CompositeActor`, which extends `CompositeEntity`. As the names imply, an `AtomicActor` is a single entity, while a `CompositeActor` is an aggregation of actors. Two further extensions implement a type system, `TypedAtomicActor` and `TypedCompositeActor`.

The `Executable` interface defines how an object can be invoked. There are eight methods. The `preinitialize()` method is assumed to be invoked exactly once during the lifetime of an execution of a model and before the type resolution (see the type system), and the `initialize()` methods is assumed to be invoked once after the type resolution. The `initialize()` method may be invoked again to restart an execution, for example, in the *-chart model (see the FSM domain). The `prefire()`, `fire()`, and `postfire()`

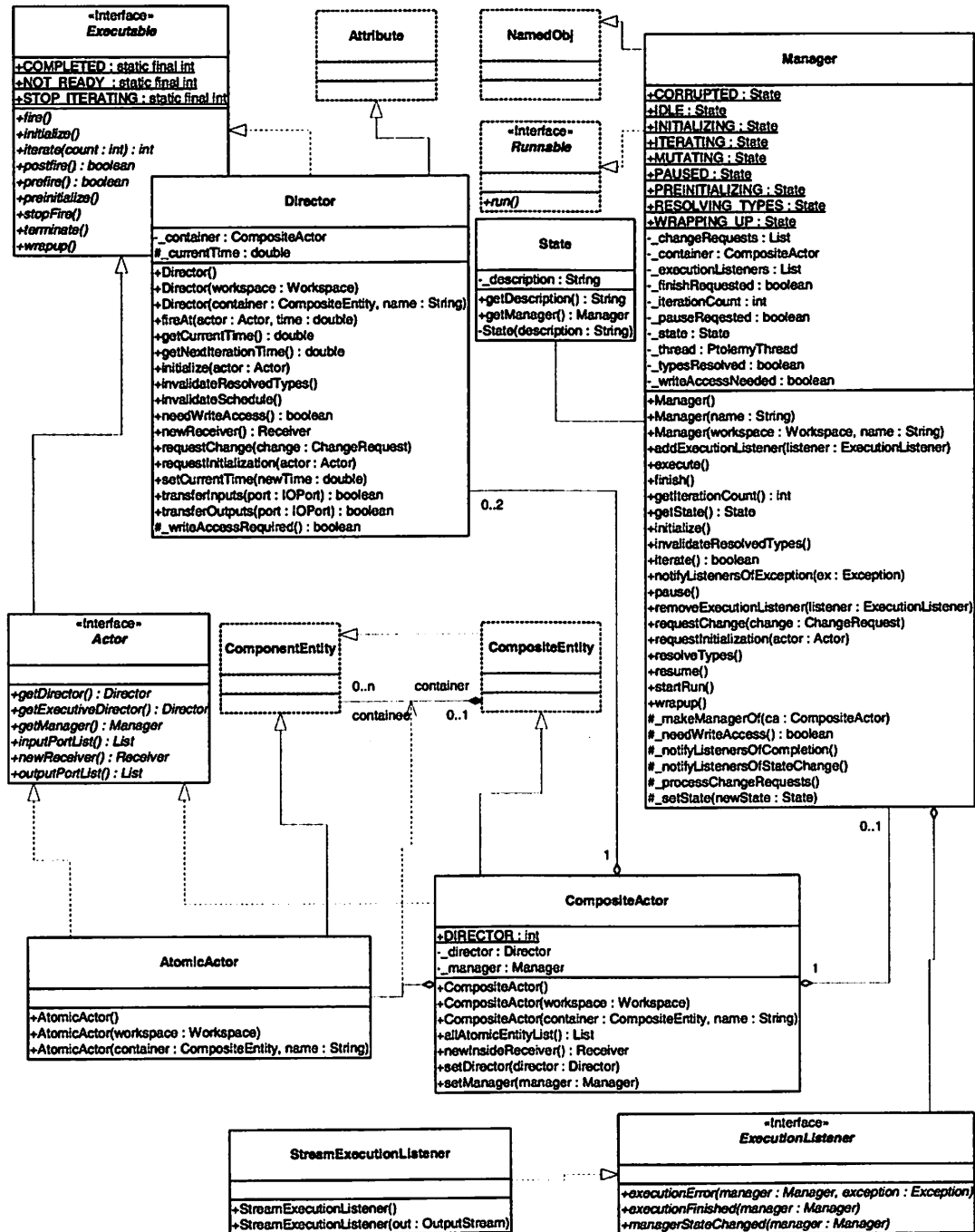

FIGURE 8.12. Basic classes in the actor package that support execution.

methods will usually be invoked many times. The `fire()` method may be invoked several times between invocations of `prefire()` and `postfire()`. The `stopFire()` method is invoked to request suspension of firing. The `wrapup()` method will be invoked exactly once per execution, at the end of the execution.

The `terminate()` method is provided as a last-resort mechanism to interrupt execution based on an external event. It is not called during the normal flow of execution. It should be used only to stop runaway threads that do not respond to more usual mechanism for stopping an execution.

An *iteration* is defined to be one invocation of `prefire()`, any number of invocation of `fire()`, and one invocation of `postfire()`. An *execution* is defined to be one invocation of `preinitialize()`, followed by one invocation of `initialize()`, followed by any number of iterations, followed by one invocation of `wrapup()`. The methods `preinitialize()`, `initialize()`, `prefire()`, `fire()`, `postfire()`, and `wrapup()` are called the *action methods*. While, the action methods in the executable interface are executed in order during the normal flow of an iteration, the `terminate()` method can be executed at any time, even during the execution of the other methods.

The `preinitialize()` method of each actor gets invoked exactly once. Typical actions of the `preinitialize()` method include creating receivers and defining the types of the ports. Higher-order function actors should construct their models in this method. The `preinitialize()` method cannot produce output data since type resolution is typically not yet done. It also gets invoked prior to any static scheduling that might occur in the domain, so it can change scheduling information.

The `initialize()` method of each actor gets invoked once after type resolution is done. It may be invoked again to restart the execution of an actor. Typical actions of the `initialize()` method include creating and initializing private data members. An actor may produce output data and schedule events in this method.

The `prefire()` method may be invoked multiple times during an execution, but only once per iteration. The `prefire()` returns true to indicate that the actor is ready to fire. In other words, a return value of true indicates “you can safely invoke my fire method,” while a false value from `prefire` means “My preconditions for firing are not satisfied. Call `prefire` again later when conditions have change.” For example, a dynamic dataflow actor might return false to indicate that not enough data is available on the input ports for a meaningful firing to occur.

The `fire()` method may be invoked multiple times during an iteration. In most domains, this method defines the computation performed by the actor. Some domains will invoke `fire()` repeatedly until some convergence condition is reached. Thus, `fire()` should not change the state of the actor. Instead, update the state in `postfire()`.

In opaque composite actors, the `fire()` method is responsible for transferring data from the opaque ports of the composite actor to the ports of the contained actors, calling the `fire()` method of the director, and transferring data from the output ports of the composite actor to the ports of outside actors. See section 8.3.4 below.

In some domains, the fire method initiates an open-ended computation. The `stopFire()` method may be used to request that firing be ended and that the `fire()` method return as soon as practical.

The `postfire()` method will be invoked exactly once during an iteration, after all invocations of the `fire()` method in that iteration. An actor may return false in `postfire` to request that the actor should not be fired again. It has concluded its mission. However, a director may elect to continue to fire the actor until the conclusion of its own iteration. Thus, the request may not be immediately honored.

The `wrapup()` method is invoked exactly once during the execution of a model, even if an exception causes premature termination of an execution. Typically, `wrapup()` is responsible for cleaning up after execution has completed, and perhaps flushing output buffers before execution ends and killing

active threads.

The `terminate()` method may be called at any time during an execution, but is not necessarily called at all. When `terminate()` is called, no more execution is important, and the actor should do everything in its power to stop execution right away. This method should be used as a last resort if all other mechanisms for stopping an execution fail.

8.3.1 Director

A *director* governs the execution of a composite entity. A *manager* governs the overall execution of a model. An example of the use of these classes is shown in figure 8.13. In that example, a top-level entity, E0, has an instance of Director, D1, that serves the role of its local director. A *local director* is responsible for execution of the components within the composite. It will perform any scheduling that might be necessary, dispatch threads that need to be started, generate code that needs to be generated, etc. In the example, D1 also serves as an executive director for E2. The *executive director* associated with an actor is the director that is responsible for firing the actor.

A composite actor that is not at the top level may or may not have its own local director. If it has a local director, then it is defined to be opaque (`isOpaque()` returns *true*). In figure 8.13, E2 has a local director and E3 does not. The contents of E3 are directly under the control of D1, as if the hierarchy were flattened. By contrast, the contents of E2 are under the control of D2, which in turn is under the control of D1. In the terminology of the previous generation, Ptolemy Classic, E2 was called a *worm-hole*. In Ptolemy II, we simply call it a opaque composite actor. It will be explained in more detail below in section 8.3.4.

We define the *director* (vs. local director or executive director) of an actor to be either its local director (if it has one) or its executive director (if it does not). A composite actor that is not at the top level has as its executive director the director of the container. Every executable actor has a director except the top-level composite actor, and that director is what is returned by the `getDirector()` method of the Actor interface (see figure 8.12).

When any action method is called on an opaque composite actor, the composite actor will generally call the corresponding method in its local director. This interaction is crucial, since it is domain-independent and allows for communication between different models of computation. When `fire()` is called in the director, the director is free to invoke iterations in the contained topology until the stopping condition for the model of computation is reached.

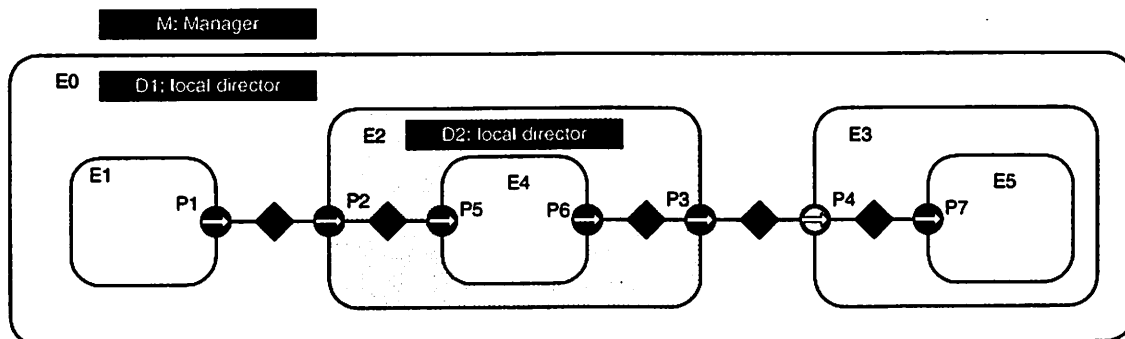

FIGURE 8.13. Example application, showing a typical arrangement of actors, directors, and managers.

The `postfire()` method of a director returns `false` to stop its execution normally. It is the responsibility of the next director up in the hierarchy (or the manager if the director is at the top level) to conclude the execution of this director by calling its `wrapup()` method.

The `Director` class provides a default implementation of an execution, although specific domains may override this implementation. In order to ensure interoperability of domains, they should stick fairly closely to the sequence.

Two common sequences of method calls between actors and directors are shown in figure 8.14 and 8.15. These differ in the shaded areas, which define the domain-specific sequencing of actor firings. In figure 8.14, the `fire()` method of the director selects an actor, invokes its `prefire()` method, and if that returns `true`, invokes its `fire()` method some number of times (domain dependent) followed by its `postfire()` method. In figure 8.15, the `fire()` method of the director invokes the `prefire()` method of all the actors before invoking any of their `fire()` methods.

When a director is initialized, via its `initialize()` method, it invokes `initialize()` on all the actors in the next level of the hierarchy, in the order in which these actors were created. The `wrapup()` method works in a similar way, *deeply* traversing the hierarchy. In other words, calling `initialize()` on a composite actor is guaranteed to initialize in all the objects contained within that actor. Similarly for `wrapup()`.

The methods `prefire()` and `postfire()`, on the other hand, are not deeply traversing functions. Calling `prefire()` on a director does not imply that the director call `prefire()` on all its actors. Some directors may need to call `prefire()` on some or all contained actors before being able to return, but some directors may not need to call `prefire()` on any contained objects at all. A director may even implement short-circuit evaluation, where it calls `prefire()` on only enough of the contained actors to determine its own return value. `Postfire()` works similarly, except that it may only be called after at least one successful call to `fire()`.

The `fire()` method is where the bulk of work for a director occurs. When a director is fired, it has complete control over execution, and may initiate whatever iterations of other actors are appropriate for the model of computation that it implements. It is important to stress that once a director is fired, outside objects do not have control over when the iteration will complete. The director may not iterate any contained actors at all, or it may iterate the contained actors forever, and not stop until `terminate()` is called. Of course, in order to promote interoperability, directors should define a finite execution that they perform in the `fire()` method.

In case it is not practical for the `fire()` method to define a bounded computation, the `stopFire()` method is provided. A director should respond when this method is called by returning from its `fire()` method as soon as practical.

In some domains, the firing of a director corresponds exactly to the sequential firing of the contained actors in a specific predetermined order. This ordering is known as a *static schedule* for the actors. Some domains support this style of execution. There is also a family of domains where actors are associated with threads.

8.3.2 Manager

While a director implements a model of computation, a *manager* controls the overall execution of a model. The manager interacts with a single composite actor, known as a *top level composite actor*. The `Manager` class is shown in figure 8.12. Execution of a model is implemented by three methods, `execute()`, `run()` and `startRun()`. The `startRun()` method spawns a thread that calls `run()`, and then immediately returns. The `run()` method calls `execute()`, but catches all exceptions and reports them to listen-

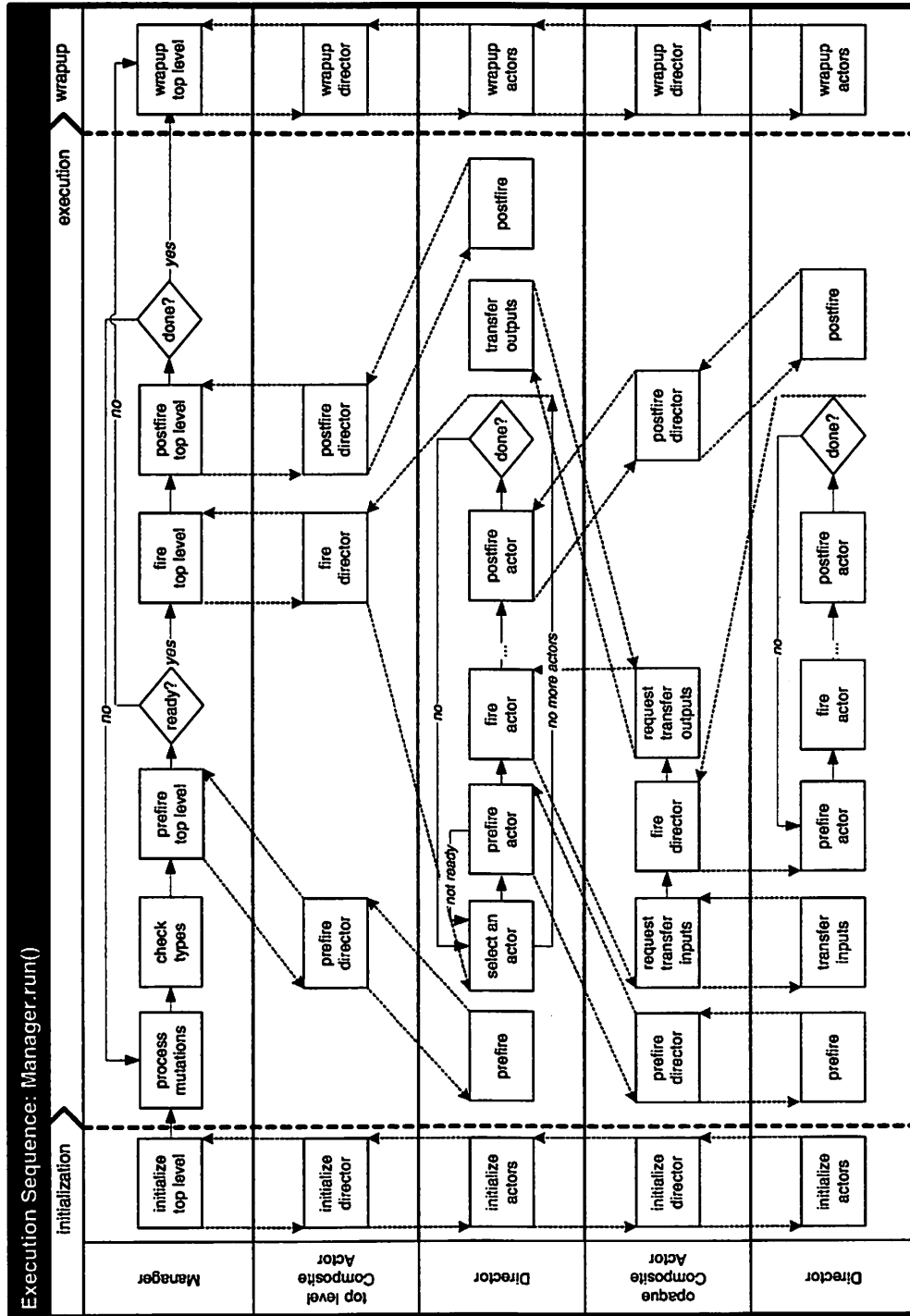

FIGURE 8.14. Example execution sequence implemented by `run()` method of the Director class.

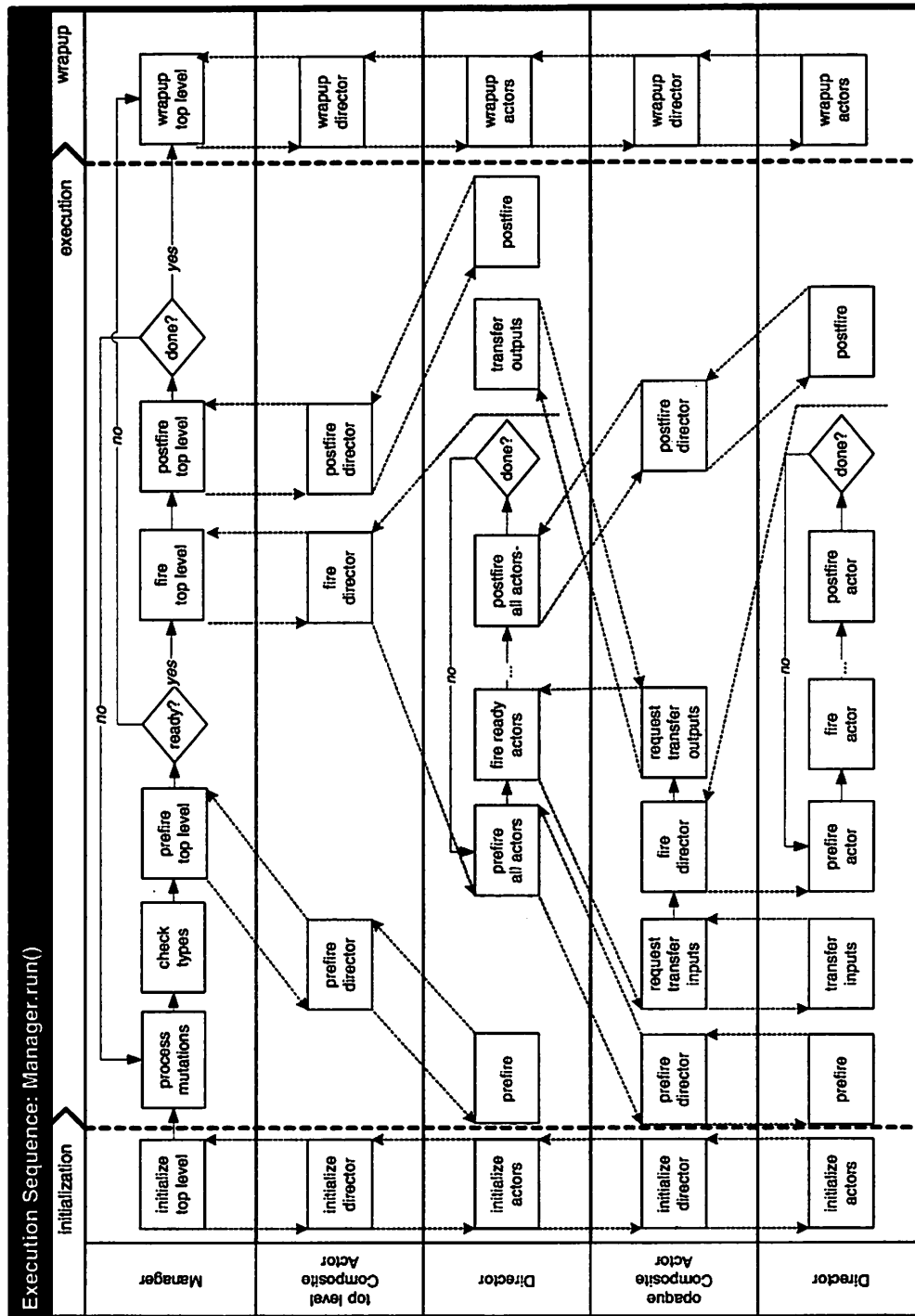

FIGURE 8.15. Alternative execution sequence implemented by `run()` method of the Director class.

ers (if there are any) or to the standard output (if there are no listeners).

More fine grain control over the execution can be achieved by calling `initialize()`, `iterate()`, and `wrapup()` on the manager directly. The `execute()` method, in fact, calls these, repeating the call to `iterate()` until it returns false. The `iterate` method invokes `prefire()`, `fire()` and `postfire()` on the top-level composite actor, and returns false if the `postfire()` in the top-level composite actor returns false.

An execution can also be ended by calling `terminate()` or `finish()` on the manager. The `terminate()` method triggers an immediate halt of execution, and should be used only if other more graceful methods for ending an execution fail. It will probably leave the model in an inconsistent state, since it works by unceremoniously killing threads. The `finish()` method allows the system to continue until the end of the current iteration in the top-level composite actor, and then invokes `wrapup()`. `Finish()` encourages actors to end gracefully by calling their `stopFire()` method.

Execution may also be paused between top-level iterations by calling the `pause()` method. This method sets a flag in the manager and calls `stopFire()` on the top-level composite actor. After each top-level iteration, the manager checks the flag. If it has been set, then the manager will not start the next top-level iteration until after `resume()` is called. In certain domains, such as the process networks domain, there is not a very well defined concept of an iteration. Generally these domains do not rely on repeated iteration firings by the manager. The call to `stopFire()` requests of these domains that they suspend execution.

8.3.3 ExecutionListener

The `ExecutionListener` interface provides a mechanism for a manager to report events of interest to a user interface. Generally a user interface will use the events to notify the user of the progress of execution of a system. A user interface can register one or more `ExecutionListeners` with a manager using the method `addExecutionListener()` in the `Manager` class. When an event occurs, the appropriate method will get called in all the registered listeners.

Two kinds of events are defined in the `ExecutionListener` interface. A listener is notified of the completion of an execution by the `executionFinished()` method. The `executionError()` method indicates that execution has ended with an error condition. The `managerStateChanged()` indicates to the listener that the manager has changed state. The new state can be obtained by calling `getState()` on the manager.

A default implementation of the `ExecutionListener` interface is provided in the `StreamExecutionListener` class. This class reports all events on the standard output.

8.3.4 Opaque Composite Actors

One of the key features of Ptolemy II is its ability to hierarchically mix models of computation in a disciplined way. The way that it does this is to have actors that are composite (non-atomic) and opaque. Such an actor was called a *wormhole* in the earlier generation of Ptolemy. Its ports are opaque and its contents are not visible via methods like `deepEntityList()`.

Recall that an instance of `CompositeActor` that is at the top level of the hierarchy must have a local director in order to be executable. A `CompositeActor` at a lower level of the hierarchy may also have a local director, in which case, it is opaque (`isOpaque()` returns *true*). It also has an executive director, which is simply the director of its container. For a composite opaque actor, the local director and executive director need not follow the same model of computation. Hence hierarchical heterogeneity.

The ports of a composite opaque actor are opaque, but it is a composite (it can contain actors and

relations). This has a number of implications on execution. Consider the simple example shown in figure 8.16. Assume that both E0 and E2 have local directors (D1 and D2), so E2 is opaque. The ports of E2 therefore are opaque, as indicated in the figure by their solid fill. Since its ports are opaque, when a token is sent from the output port P1, it is deposited in P2, not P5.

In the execution sequences of figures 8.14 and 8.15, E2 is treated as an atomic actor by D1; i.e. D1 acts as an executive director to E2. Thus, the fire() method of D1 invokes the prefire(), fire(), and post-fire() methods of E1, E2, and E3. The fire() method of E2 is responsible for transferring the token from P2 to P5. It does this by delegating to its local director, invoking its transferInputs() method. It then invokes the fire() method of D2, which in turn invokes the prefire(), fire(), and postfire() methods of E4.

During its fire() method, E2 will invoke the fire() method of D2, which typically will fire the actor E4, which may send a token via P6. Again, since the ports of E2 are opaque, that token goes only as far as P3. The fire() method of E2 is then responsible for transferring that token to P4. It does this by delegating to its executive director, invoking its transferOutputs() method.

The CompositeActor class delegates transfer of its inputs to its local director, and transfer of its outputs to its executive director. This is the correct organization, because in each case, the director appropriate to the model of computation of the destination port is the one handling the transfer. It can therefore handle it in a manner appropriate to the receiver in that port.

Note that the port P3 is an output, but it has to be capable of receiving data from the inside, as well as sending data to the outside. Thus, despite being an output, it contains a receiver. Such a receiver is called an *inside receiver*. The methods of IOPort offer only limited access to the inside receivers (only via the getInsideReceivers() method and getReceivers(relation), where relation is an inside linked relation).

In general, a port may be both an input and an output. An opaque port of a composite opaque actor, thus, must be capable of storing two distinct types of receivers, a set appropriate to the inside model of computation, obtained from the local director, and a set appropriate to the outside model of computation, obtained from its executive director. Most methods that access receivers, such as hasToken() or hasRoom(), refer only to the outside receivers. The use of the inside receivers is rather specialized, only for handling composite opaque actors, so a more basic interface is sufficient.

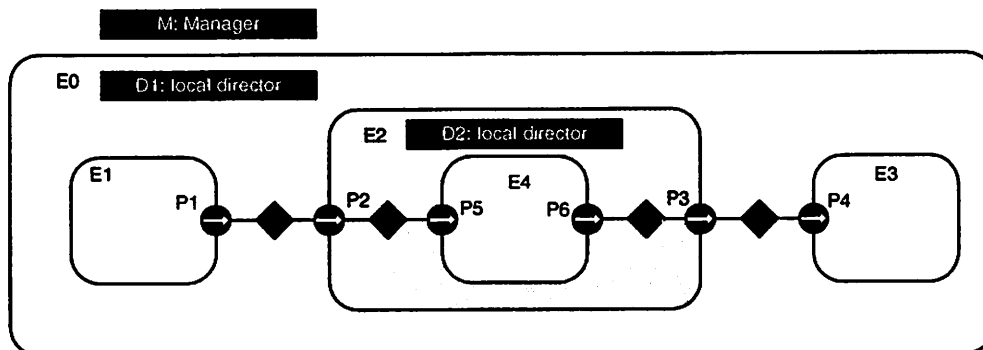

FIGURE 8.16. An example of an opaque composite actor. E0 and E2 both have local directors, not necessarily implementing the same model of computation.

8.4 Scheduler and Process Support

The actor package has two subpackages, actor.sched, which provides rudimentary support for domains that use static schedulers to control the invocation of actors, and actor.process, which provides support for domains where actors are processes. The UML diagrams are shown in figure 8.17 and figure 8.18.

8.4.1 Statically Scheduled Domains

The StaticSchedulingDirector class extends the Director base class to add a scheduler. The scheduler (an instance of the Scheduler class) creates an instance of the Schedule class which represents a statically determined sequence of actor firings. The scheduler also caches the schedule as necessary until it is invalidated by the director. This means that domains with a statically determined schedule (such as CT and SDF) need only implement the action methods in the director and a scheduler with the

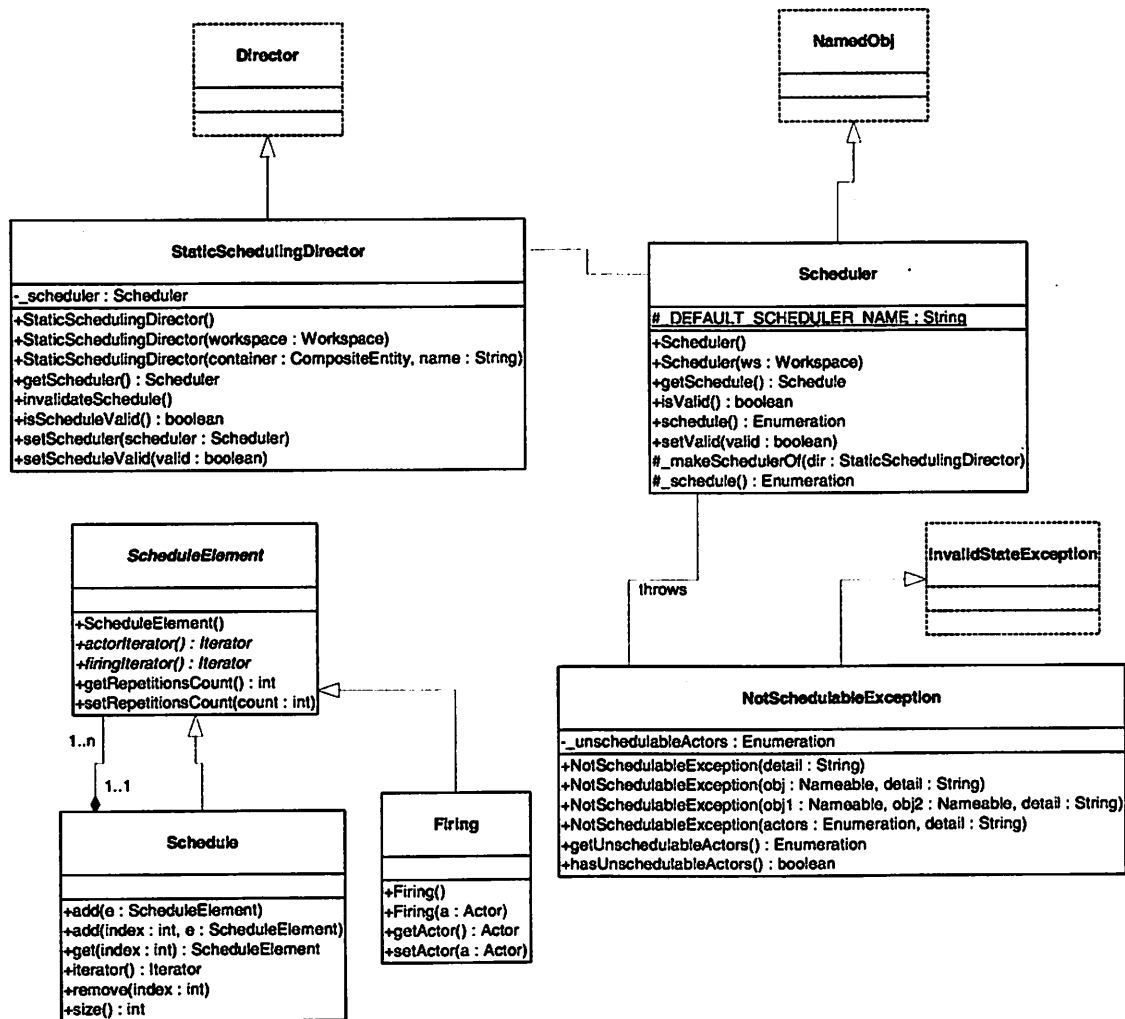

FIGURE 8.17. UML static structure diagram for the actor.sched package.

appropriate scheduling algorithm.

The Schedule base class contains a list of schedule elements, each with a repetitions factor that determines the number of times that element will be repeated. Since a schedule itself is a schedule element, schedules can be defined recursively. Another type of schedule element is a firing, which represents a firing of a single actor. An iterator over all firings contained by a schedule is returned by the

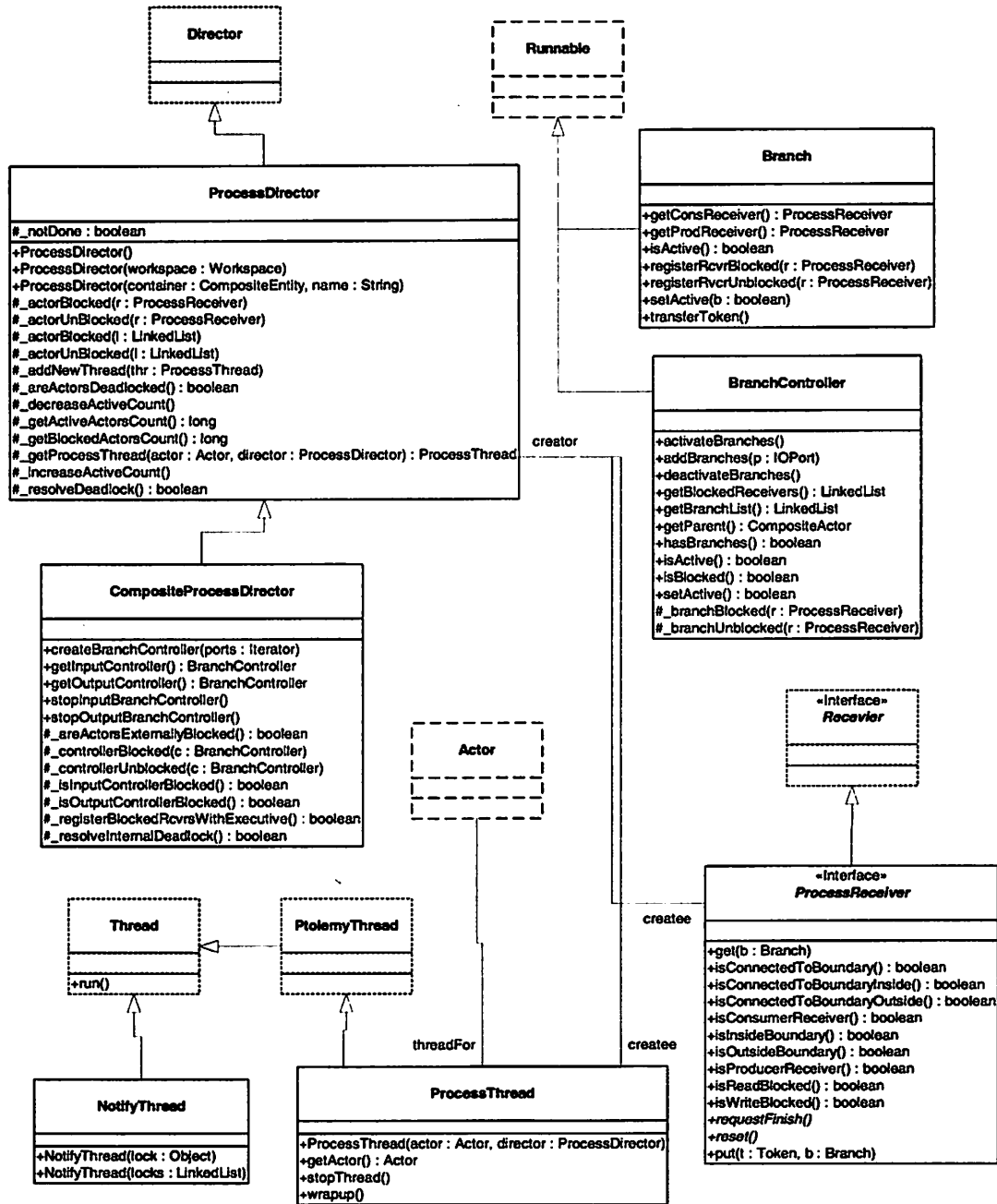

FIGURE 8.18. UML static structure diagram for the actor.process package.

firingIterator() method on the schedule. In the iterator, the schedule is expanded recursively, with each firing repeated the appropriate number of times.¹

8.4.2 Process Domains

Many domains, such as CSP, PN and DDE, consist of independent processes that are communicating in some way. These domains are collectively termed *process domains*. The actor.process package provides the following base classes that can be used to implement process domains.

ProcessThread. In a process domain, each actor represents an independently executing process. In Ptolemy II, this is achieved by creating a separate Java thread for each actor [72][47]. Each of these threads is an instance of ptolemy.actor.ProcessThread.

The thread for each actor is started in the prefire() method of the director. After starting, this thread repeatedly calls the prefire(), fire(), and postfire() methods of its associated actor. This sequence continues until the actor's postfire() method returns false. The only way for an actor to terminate gracefully in PN is by returning from its fire() method and then returning false in its postfire() method. If an actor finishes execution as above, then the thread calls the wrapup() method of the actor. Once this method returns, the thread informs the director about the termination of this actor and finishes its own execution. The actor will not be fired again unless the director creates and starts a new thread for the actor.

ProcessReceiver. In the process domains, receivers represent the communication and synchronization points between different threads. To facilitate creating these domains, receivers in process domains should implement the ProcessReceiver interface. This interface provides extended information about status of the receiver, and the threads that may be interacting with the receiver.

ProcessDirector and CompositeProcessDirector. These classes are base classes for directors in the process-based domains. It provides some basic infrastructure for creating and managing threads. Most importantly, it provides a strategy pattern for handling deadlock between threads. Subclasses usually override methods in this class to handle deadlock in a domain-dependent fashion. In order to detect deadlocks, this base class maintains a count of how many actors in the system are executing and how many are blocked for some reason. This method of detecting deadlock is suggested in [46]. When no threads are able to run, the director calls the _resolveDeadlock() method to attempt to resolve the deadlock.

The initialize() method of the process director creates the receivers in the input ports of the actors, creates a thread for each actor and initializes these actors. It also initializes the count of active actors in the model to the number of actors in the composite actor. The prefire() method starts up all the created threads. This method returns true by default. The fire() method of a process director does not actually fire any contained actors. Instead, each actor is iterated by its associated process thread. The fire method simply blocks the calling thread until deadlock of the process threads occurs. In this case, the calling thread is unblocked and the fire method returns. The postfire() method simply returns true if the director was able to resolve the deadlock at the end of the fire method, or false otherwise. Returning true implies that if some new data is provided to the composite actor it can resume execution. Returning false implies that this composite actor will not be fired again. In that case, the executive director or the manager will call the wrapup() method of the top-level composite actor, which in turn calls the

1. Note that creating an iterator does not require expanding the data structure of the schedule into a list first.

wrapup() method of the director. This causes the director to terminate the execution of the composite actor.

Introduction to Java Threads. The process domains, like the rest of Ptolemy II, are written entirely in Java and take advantage of the features built into the language. In particular, they rely heavily on threads and on monitors for controlling the interaction between threads. In any multi-threaded environment, care has to be taken to ensure that the threads do not interact in unintended ways, and that the model does not deadlock. Note that deadlock in this sense is a bug in the *modeling environment*, which is different from the deadlock talked about before which may or may not be a bug in the model being executed.

A monitor is a mechanism for ensuring mutual exclusion between threads. In particular if a thread has a particular monitor, acquired in order to execute some code, then no other thread can simultaneously have that monitor. If another thread tries to acquire that monitor, it stalls until the monitor becomes available. A monitor is also called a *lock*, and one is associated with every object in Java.

Code that is associated with a lock is defined by the *synchronized* keyword. This keyword can either be in the signature of a method, in which case the entire method body is associated with that lock, or it can be used in the body of a method using the syntax:

```
synchronized(object) {  
    ... //Part of code that requires exclusive lock on object  
}
```

This causes the code inside the brackets to be associated with the lock belonging to the specified object. In either case, when a thread tries to execute code controlled by a lock, it must either acquire the lock or stall until the lock becomes available. If a thread stalls when it already has some locks, those locks are not released, so any other threads waiting on those locks cannot proceed. This can lead to deadlock when all threads are stalled waiting to acquire some lock they need.

A thread can voluntarily relinquish a lock when stalling by calling *object.wait()* where *object* is the object to relinquish and wait on. This causes the lock to become available to other threads. A thread can also wake up any threads waiting on a lock associated with an object by calling *notifyAll()* on the object. Note that to issue a *notifyAll()* on an object it is necessary to own the lock associated with that object first. By careful use of these methods it is possible to ensure that threads only interact in intended ways and that deadlock does not occur.

Approaches to locking used in the process domains. One of the key coding patterns followed is to wrap each *wait()* call in a while loop that checks some flag. Only when the flag is set to false can the thread proceed beyond that point. Thus the code will often look like

```
synchronized(object) {  
    ...  
    while(flag) {  
        object.wait();  
    }  
    ...  
}
```

The advantage to this is that it is not necessary to worry about what other thread issued the *notifyAll()* on the lock; the thread can only continue when the *notifyAll()* is issued *and* the flag has been set to

wrapup() method of the director. This causes the director to terminate the execution of the composite actor.

Introduction to Java Threads. The process domains, like the rest of Ptolemy II, are written entirely in Java and take advantage of the features built into the language. In particular, they rely heavily on threads and on monitors for controlling the interaction between threads. In any multi-threaded environment, care has to be taken to ensure that the threads do not interact in unintended ways, and that the model does not deadlock. Note that deadlock in this sense is a bug in the *modeling environment*, which is different from the deadlock talked about before which may or may not be a bug in the model being executed.

A monitor is a mechanism for ensuring mutual exclusion between threads. In particular if a thread has a particular monitor, acquired in order to execute some code, then no other thread can simultaneously have that monitor. If another thread tries to acquire that monitor, it stalls until the monitor becomes available. A monitor is also called a *lock*, and one is associated with every object in Java.

Code that is associated with a lock is defined by the *synchronized* keyword. This keyword can either be in the signature of a method, in which case the entire method body is associated with that lock, or it can be used in the body of a method using the syntax:

```
synchronized(object) {
    ... //Part of code that requires exclusive lock on object
}
```

This causes the code inside the brackets to be associated with the lock belonging to the specified object. In either case, when a thread tries to execute code controlled by a lock, it must either acquire the lock or stall until the lock becomes available. If a thread stalls when it already has some locks, those locks are not released, so any other threads waiting on those locks cannot proceed. This can lead to deadlock when all threads are stalled waiting to acquire some lock they need.

A thread can voluntarily relinquish a lock when stalling by calling *object.wait()* where *object* is the object to relinquish and wait on. This causes the lock to become available to other threads. A thread can also wake up any threads waiting on a lock associated with an object by calling *notifyAll()* on the object. Note that to issue a *notifyAll()* on an object it is necessary to own the lock associated with that object first. By careful use of these methods it is possible to ensure that threads only interact in intended ways and that deadlock does not occur.

Approaches to locking used in the process domains. One of the key coding patterns followed is to wrap each *wait()* call in a while loop that checks some flag. Only when the flag is set to false can the thread proceed beyond that point. Thus the code will often look like

```
synchronized(object) {
    ...
    while(flag) {
        object.wait();
    }
    ...
}
```

The advantage to this is that it is not necessary to worry about what other thread issued the *notifyAll()* on the lock; the thread can only continue when the *notifyAll()* is issued *and* the flag has been set to

false.

One place that contention between threads often occurs is when a thread tries to acquire another lock only to issue a `notifyAll()` on it. To reduce the contention, it is often easiest if the `notifyAll()` is issued from a new thread which has no locks that could be held if it stalls. This is often used in the CSP domain to wake up any threads waiting on receivers after a pause or when terminating the model. The `ptolemy.actor.process.NotifyThread` class can be used for this purpose. This class takes a list of objects in a linked list, or a single object, and issues a `notifyAll()` on each of the objects from within a new thread.

Synchronization Hierarchy. Previously we have discussed how model deadlock is resolved in process domains. Separate from these notions is a different kind of deadlock that can occur in a modeling environment if the environment is not designed properly. This notion of deadlock can occur if a system is not *thread safe*. Given the extensive use of Java threads throughout Ptolemy II, great care has been taken to ensure thread safety; we want no *bugs* to exist that might lead to deadlock based on the structure of the Ptolemy II modeling environment. Ptolemy II uses monitors to guarantee thread safety. A *monitor* is a method for ensuring mutual exclusion between threads that both have access to a given portion of code. To ensure mutual exclusion, threads must acquire a monitor (or *lock*) in order to access a given portion of code. While a thread owns a lock, no other threads can access the corresponding code.

There are several objects that serve as locks in Ptolemy II. In the process domains, there are four primary objects upon which locking occurs: `Workspace`, `ProcessReceiver`, `ProcessDirector` and `AtomicActor`. The danger of having multiple locks is that separate threads can acquire the locks in competing orders and this can lead to deadlock. A simple illustration is shown in figure 8.19. Assume that both lock *A* and lock *B* are necessary to perform a given set of operations and that both thread 1 and thread 2 want to perform the operations. If thread 1 acquires *A* and then attempts to acquire *B* while thread 2 does the reverse, then deadlock can occur.

There are several ways to avoid the above problem. One technique is to combine locks so that large sets of operations become atomic. Unfortunately this approach is in direct conflict with the whole purpose behind multi-threading. As larger and larger sets of operations utilize a single lock, the limit of the corresponding concurrent program is a sequential program!

Another approach is to adhere to a hierarchy of locks. A hierarchy of locks is an agreed upon order in which locks are acquired. In the above case, it may be enforced that lock *A* is always acquired before lock *B*. A hierarchy of locks will guarantee thread safety [47].

The process domains have an unenforced hierarchy of locks. It is strongly suggested that users of Ptolemy II process domains adhere to this suggested locking hierarchy. The hierarchy specifies that

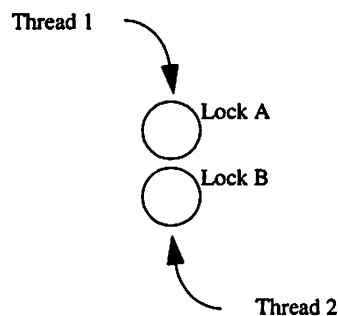

FIGURE 8.19. Deadlock Due to Unordered Locking.

locks be acquired in the following order:

Workspace \longrightarrow **ProcessReceiver** \longrightarrow **ProcessDirector** \longrightarrow **AtomicActor**

The way to apply this rule is to prevent synchronized code in any of the above objects from making a call to code that is to the left of the object in question.

There is one further rule that implementors of process domains should be aware of. A thread should give up all the read permissions on the workspace before calling the wait() method on the receiver object. This commonly happens in the get() and put() methods of process receivers, which implement the synchronization between threads. We require this because of the explicit modeling of mutual exclusion between the read and write activities on the workspace. If a thread holds read permission on the workspace and suspends while a second thread requires a write access on the workspace before performing the action that the first thread is waiting for, a deadlock results. Furthermore, a thread must also regain those read accesses after returning from the call to the wait() method. For this a wait(Object object) method is provided in the class Workspace that releases read accesses on the workspace, calls wait() on the argument obj, and regains read access on the workspace before returning.

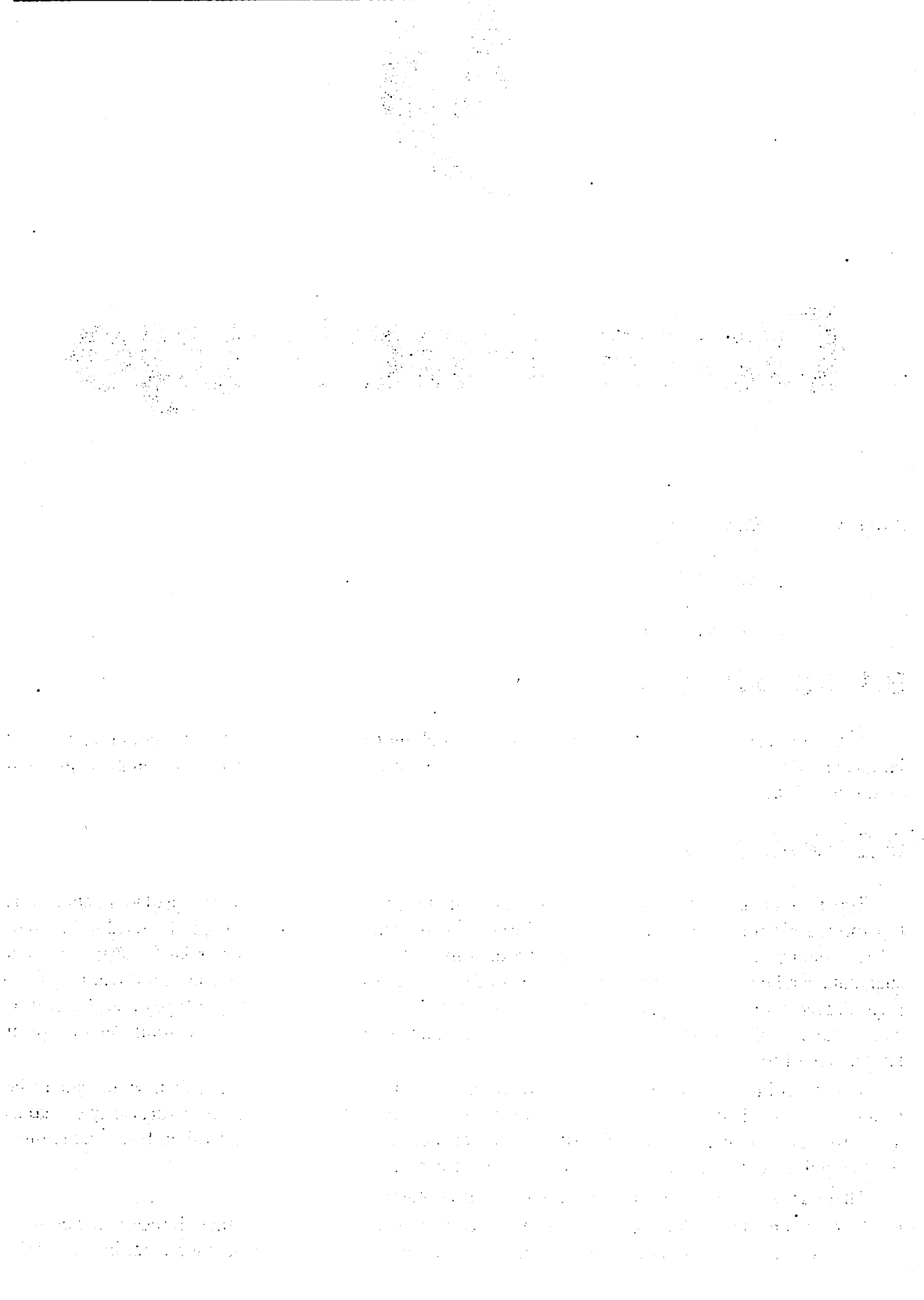

9

Data Package

Authors: *Bart Kienhuis*
 Edward A. Lee
 Xiaojun Liu
 Neil Smyth
 Yuhong Xiong

9.1 Introduction

The data package provides data encapsulation, polymorphism, parameter handling, an expression language, and a type system. Figure 9.1 shows the key classes in the main package (subpackages will be discussed later).

9.2 Data Encapsulation

The Token class and its derived classes encapsulate application data. The encapsulated data can be transported via message passing between Ptolemy II objects. Alternatively, it can be used to parameterize Ptolemy II objects. Encapsulating the data in such a way provides a standard interface so that such data can be handled uniformly regardless of its detailed structure. Such encapsulation allows for a great degree of extensibility, permitting developers to extend the library of data types that Ptolemy II can handle. It also permits a user interface to interact with application data without detailed prior knowledge of the structure of the data.

Tokens in Ptolemy II, except ObjectToken, are immutable. This means that their value cannot be changed after the instance of Token is constructed. The value of a token must therefore be specified as a constructor argument, and there must be no other mechanism for setting the value. If the value must be changed, a new instance of Token must be constructed.

There are several reasons for making tokens immutable.

- First, when a token is to be sent to several receivers, we want to be sure that all receivers get the same data. Each receiver is sent a reference to the same token. If the Token were not immutable,

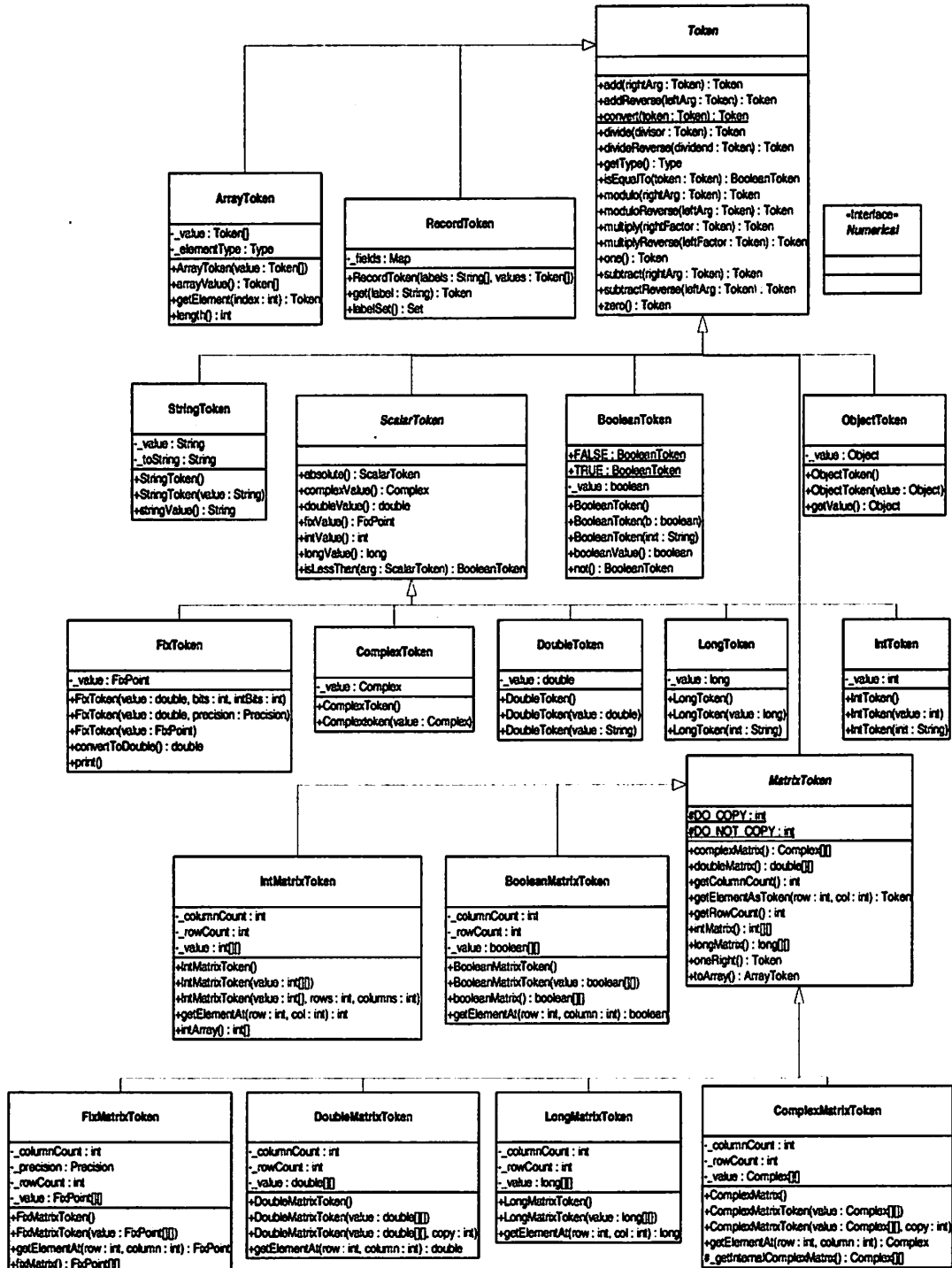

FIGURE 9.1. Static Structure Diagram (Class Diagram) for the classes in the data package.

then it would be necessary to clone the token for all receivers after the first one.

- Second, we use tokens to parameterize objects, and parameters have mutual dependencies. That is, the value of a parameter may depend on the value of other parameters. The value of a parameter is represented by an instance of Token. If that token were allowed to change value without notifying the parameter, then the parameter would not be able to notify other parameters that depend on its value. Thus, a mutable token would have to implement a publish-and-subscribe mechanism so that parameters could subscribe and thus be notified of any changes. By making tokens immutable, we greatly simplify the design.
- Finally, having our Tokens immutable makes them similar in concept to the data wrappers in Java, like Double, Integer, etc., which are also immutable.

An ObjectToken contains a reference to an arbitrary Java object created by the user. Since the user may modify the object after the token is constructed, ObjectToken is an exception to immutability. Moreover, the getValue() method returns a reference to the object. That reference can be used to modify the object. Although ObjectToken could clone the object in the constructor and return another clone in getValue(), this would require the object to be cloneable, which severely limits the use of the ObjectToken. In addition, even if the object is cloneable, since the default implementation of clone() only makes a shallow copy, it is still not enough to enforce immutability. In addition, cloning a large object could be expensive. For these reasons, the ObjectToken does not enforce immutability, but rather relies on the cooperation from the user. Violating this convention could lead to unintended non-determinism.

For matrix tokens, immutability requires the contained matrix (Java array) to be copied when the token is constructed, and when the matrix is returned in response to queries such as intMatrix(), doubleMatrix(), etc. This is because arrays are objects in Java. Since the cost of copying large matrices is non-trivial, the user should not make more queries than necessary. The getElementAt() method should be used to read the contents of the matrix.

ArrayToken is a token that contains an array of tokens. All the element tokens must have the same type, but that type can be any token type, including the type of the ArrayToken itself. That is, we can have an array of arrays. ArrayToken is different from the MatrixTokens in that MatrixTokens contain primitive data, such as int, double, while ArrayToken contains Ptolemy Tokens. MatrixTokens are very efficient for storing two dimensional primitive data, while ArrayToken offers more flexibility in type specifications.

RecordToken contains a set of labeled values, like the structure in the C language. The values can be arbitrary tokens, and they are not required to have the same type. ArrayToken and RecordToken will be discussed in more detail in the Type System chapter.

9.3 Polymorphism

9.3.1 Polymorphic Arithmetic Operators

One of the goals of the data package is to support polymorphic operations between tokens. For this, the base Token class defines methods for the primitive arithmetic operations, which are add(), multiply(), subtract(), divide(), modulo() and equals(). Derived classes override these methods to provide class specific operation where appropriate. The objective here is to be able to say, for example,

```
a.add(b)
```

where a and b are arbitrary tokens. If the operation a + b makes sense for the particular tokens, then

the operation is carried out and a token of the appropriate type is returned. If the operation does not make sense, then an exception is thrown. Consider the following example

```
IntToken a = new IntToken(5);
DoubleToken b = new DoubleToken(2.2);
StringToken c = new StringToken("hello");
```

then

```
a.add(b)
```

gives a new DoubleToken with value 7.2,

```
a.add(c)
```

gives a new StringToken with value "5Hello", and

```
a.modulo(c)
```

throws an exception. Thus in effect we have overloaded the operators +, -, *, /, %, and ==.

It is not always immediately obvious what is the correct implementation of an operation and what the return type should be. For example, the result of adding an integer token to a double-precision floating-point token should probably be a double, not an integer. The mechanism for making such decisions depends on a *type hierarchy* that is defined separately from the class hierarchy. This type hierarchy is explained in detail below.

The token classes also implement the methods zero() and one() which return the additive and multiplicative identities respectively. These methods are overridden so that each token type returns a token of its type with the appropriate value. For numerical matrix tokens, zero() returns a zero matrix whose dimension is the same as the matrix of the token where this method is called; and one() returns the left identity, i.e., it returns an identity matrix whose dimension is the same as the number of rows of the matrix of the token. Another method oneRight() is also provided in numerical matrix tokens, which returns the right identity, i.e., the dimension is the same as the number of columns of the matrix of the token.

Since data is transferred between entities using Tokens, it is straightforward to write polymorphic actors that receive tokens on their inputs, perform one or more of the overloaded operations and output the result. For example an add actor that looks like this:

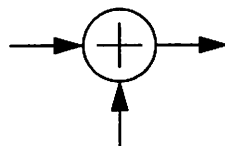

might contain code like:

```
Token input1, input2, output;
// read Tokens from the input channels into input1 and input2 variables
output = input1.add(input2);
// send the output Token to the output channel.
```

We call such actors *data polymorphic* to contrast them from *domain polymorphic* actors, which are actors that can operate in multiple domains. Of course, an actor may be both data and domain polymorphic.

9.3.2 Lossless Type Conversion

For the above arithmetic operations, if the two tokens being operated on have different types, type conversion is needed. In Ptolemy II, only conversions that do not lose information are implicitly performed. Lossy conversions must be explicitly done by the user, either through casting or by other means. The lossless type conversion relation among different token types is modeled as a partially ordered set called the *type lattice*, shown in figure 9.2. In that diagram, type *A* is *greater than* type *B* if there is a path upwards from *B* to *A*. Thus, ComplexMatrix is greater than Int. Type *A* is *less than* type *B* if there is a path downwards from *B* to *A*. Thus, Int is less than ComplexMatrix. Otherwise, types *A* and *B* are *incomparable*. Complex and Long, for example, are incomparable.

In the type lattice, a type can be losslessly converted to any type greater than it. This hierarchy is related to the inheritance hierarchy of the token classes in that a subclass is always less than its super class in the type lattice. However, some adjacent types in the lattice are not related by inheritance.

This hierarchy is realized by the TypeLattice class in the data.type subpackage. Each node in the lattice is an instance of the Type interface. The TypeLattice class provides methods to compare two token types.

Two of the types, *Numerical* and *Scalar*, are abstract. They cannot be instantiated. This is indicated

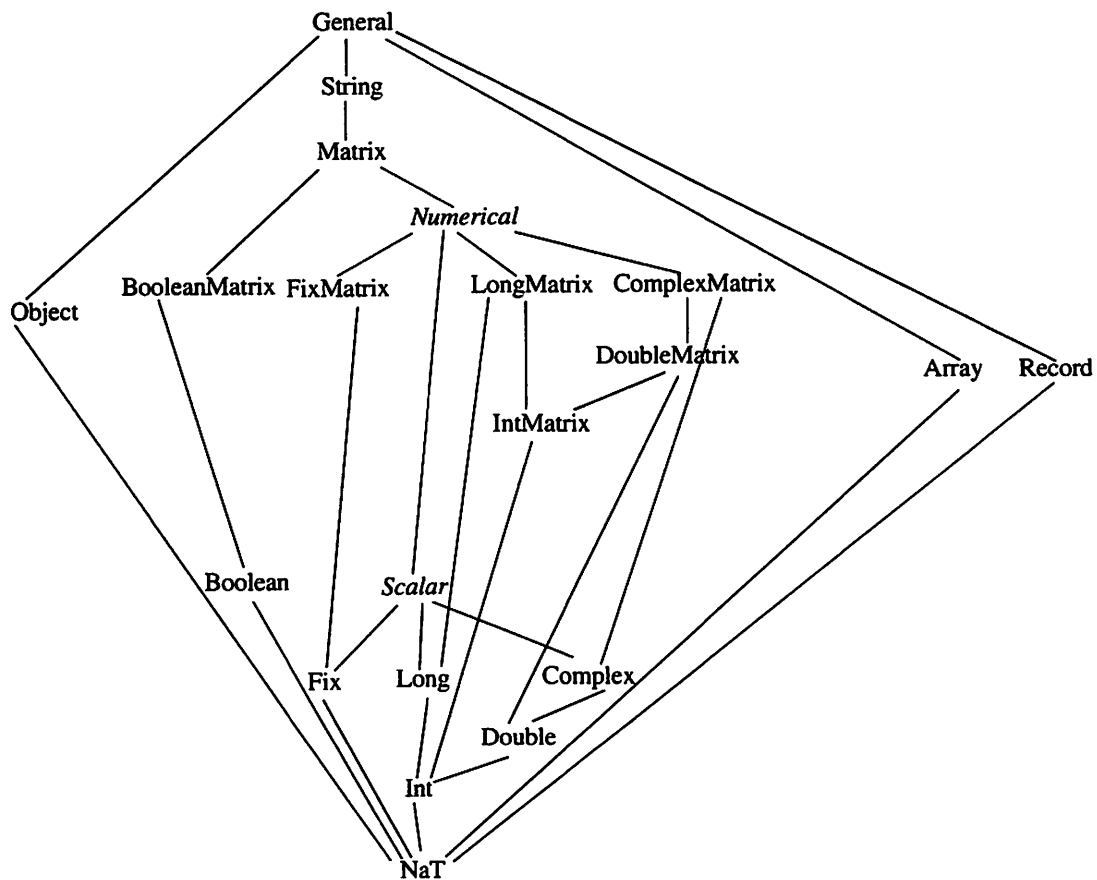

FIGURE 9.2. The type lattice.

in the type lattice by italics.

Type conversion is done by the static method `convert()` in the token classes. This method converts the argument into an instance of the class implementing this method. For example, `DoubleToken.convert(Token token)` converts the specified token into an instance of `DoubleToken`. The `convert()` method can convert any token immediately below it in the type hierarchy into an instance of its own class. If the argument is higher in the type hierarchy, or is incomparable with its own class, `convert()` throws an exception. If the argument to `convert()` is already an instance of its own class, it is returned without any change.

The implementation of the `add()`, `subtract()`, `multiply()`, `divide()`, `modulo()`, and `equals()` methods requires that the type of the argument and the implementing class be comparable in the type hierarchy. If this condition is not met, these methods will throw an exception. If the type of the argument is lower than the type of the implementing class, then the argument is converted to the type of the implementing class before the operation is carried out.

The implementation is more involved if the type of the argument is higher than the implementing class, in which case, the conversion must be done in the other direction. Since the `convert()` method only knows how to convert types lower in the type hierarchy up, the operation must take place in the class of the argument. Furthermore, since many of the supported operations are not commutative, for example, "Hello" + "world" is not the same as "world" + "Hello", and 3-2 is not the same as 2-3, the implementation of the arithmetic operations cannot simply call the same method on the class of the argument. Instead, a separate set of methods must be used. These methods are `addReverse()`, `subtractReverse()`, `multiplyReverse()`, `divideReverse()`, and `moduloReverse()`. The equality check is always commutative so no `equalsReverse()` is needed. Under this setup, `a.add(b)` means $a+b$, and `a.addReverse(b)` means $b+a$, where a and b are both tokens. If, for example, when `a.add(b)` is invoked and the type of b is higher than a , the `add()` method of a will automatically call `b.addReverse(a)` to carry out the addition.

For scalar and matrix tokens, methods are also provided to convert the content of the token into another numeric type. In `ScalarToken`, these methods are `intValue()`, `longValue()`, `doubleValue()`, `fixValue()`, and `complexValue()`. In `MatrixToken`, the methods are `intMatrix()`, `longMatrix()`, `doubleMatrix()`, `fixMatrix()`, and `complexMatrix()`. The default implementation in these two base classes just throw an exception. Derived classes override the methods if the corresponding conversion is lossless, returning a new instance of the appropriate class. For example, `IntToken` overrides all the methods defined in `ScalarToken`, but `DoubleToken` does not override `intValue()`. A double cannot, in general, be losslessly converted to an integer.

9.3.3 Limitations

As of this writing, the following issues remain open:

- For numerical matrix tokens, only the `add()` and `addReverse()` methods are supported; other arithmetic operations are not implemented yet.

9.4 Variables and Parameters

In Ptolemy II, any instance of `NamedObj` can have attributes, which are instances of the `Attribute` class. A *variable* is an attribute that contains a token. Its value can be specified by an expression that can refer to other variables. A *parameter* is identical to a variable, but realized by instances of the `Parameter` class, which is derived from `Variable` and adds no functionality. See figure 9.3.

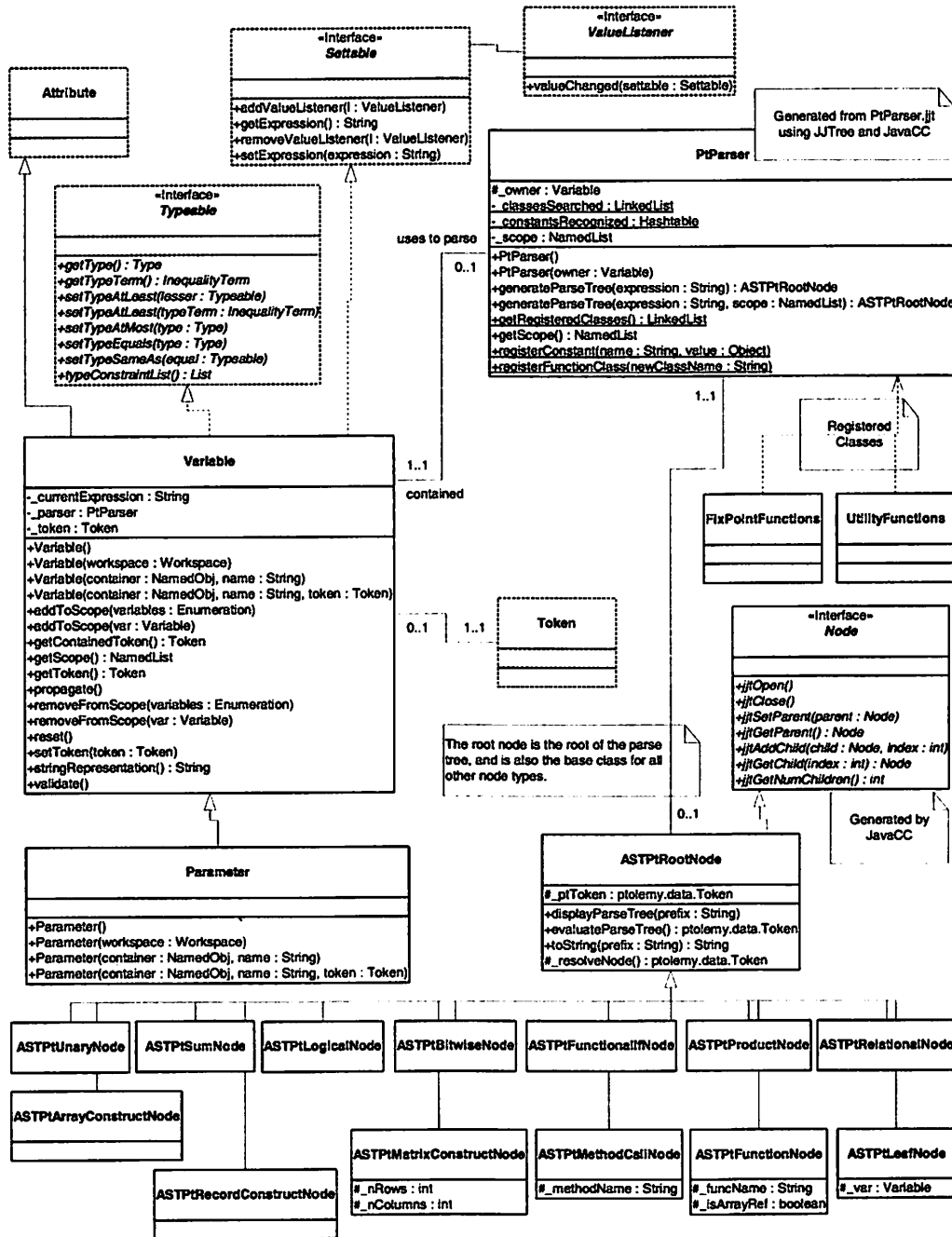

FIGURE 9.3. Static structure diagram for the data.expr package.

The reason for having two classes with identical interfaces and functionality, `Variable` and `Parameter`, is that their intended uses are different. Parameters are meant to be visible to the end user of a component, whereas variables are meant to operate behind the scenes, unseen. A GUI, for example, might present parameters for editing, but not variables.

9.4.1 Values

The value of a variable can be specified by a token passed to a constructor, a token set using the `setToken()` method, or an expression set using the `setExpression()` method.

When the value of a variable is set by `setExpression()`, the expression is not actually evaluated until you call `getToken()` or `getType()`. This is important, because it implies that a set of interrelated expressions can be specified in any order. Consider for example the sequence:

```
Variable v3 = new Variable(container, "v3");
Variable v2 = new Variable(container, "v2");
Variable v1 = new Variable(container, "v1");
v3.setExpression("v1 + v2");
v2.setExpression("1.0");
v1.setExpression("2.0");
v3.getToken();
```

Notice that the expression for `v3` cannot be evaluated when it is set because `v2` and `v1` do not yet have values. But there is no problem because the expression is not evaluated until `getToken()` is called. Obviously, an expression can only reference variables that are added to the scope of this variable before the expression is evaluated (i.e., before `getToken()` is called). Otherwise, `getToken()` will throw an exception. By default, all variables contained by the same container, and those contained by the container's container, are in the scope of this variable. Thus, in the above, all three variables are in each other's scope because they belong to the same container. This is why the expression "`v1 + v2`" can be evaluated.

A variable can also be reset. If the variable was originally set from a token, then this token is placed again in the variable, and the type of the variable is set to equal that of the token. If the variable was originally given an expression, then this expression is placed again in the variable (but not evaluated), and the type is reset to null. The type will be determined when the expression is evaluated or when type resolution is done.

9.4.2 Types

Ptolemy II, in contrast to Ptolemy Classic, does not have a plethora of type-specific parameter classes. Instead, a parameter has a type that reflects the token it contains. You can constrain the allowable types of a parameter or variable using the following mechanisms:

- You can require the variable to have a specific type. Use the `setTypeEquals()` method.
- You can require the type to be at most some particular type in the type hierarchy (see the Type System chapter to see what this means).
- You can constrain the type to be the same as that of some other object that implements the `Typeable` interface.

- You can constrain the type to be at least that of some other object that implements the `Typeable` interface.

Except for the first type constraint, these are not checked by the `Variable` class. They must be checked by a type resolution algorithm, which is implemented in the `graph` package.

The type of the variable can be specified in a number of ways, all of which require the type to be consistent with the specified constraints (or an exception will be thrown):

- It can be set directly by a call to `setTypeEquals()`. If this call occurs after the variable has a value, then the specified type must be compatible with the value. Otherwise, an exception will be thrown. Type resolution will not change the type set through `setTypeEquals()` unless the argument of that call is null. If this method is not called, or called with a null argument, type resolution will resolve the variable type according to all the type constraints. Note that when calling `setTypeEquals()` with a non-null argument while the variable already contains a non-null token, the argument must be a type no less than the type of the contained token. To set type of the variable lower than the type of the currently contained token, `setToken()` must be called with a null argument before `setTypeEquals()`.
- Setting the value of the variable to a non-null token constrains the variable type to be no less than the type of the token. This constraint will be used in type resolution, together with other constraints.
- The type is also constrained when an expression is evaluated. The variable type must be no less than the type of the token the expression is evaluated to.
- If the variable does not yet have a value, then the type of a variable may be determined by type resolution. In this case, a set of type constraints is derived from the expression of the variable (which presumably has not yet been evaluated, or the type would be already determined). Additional type constraints can be added by calls to the `setTypeAtLeast()` and `setTypeSameAs()` methods.

Subject to specified constraints, the type of a variable can be changed at any time. Some of the type constraints, however, are not verified until type resolution is done. If type resolution is not done, then these constraints are not enforced. Type resolution is normally done by the `Manager` that executes a model.

The type of the variable may change when `setToken()` or `setExpression()` is called.

- If no expression, token, or type has been specified for the variable, then the type becomes that of the current value being set.
- If the variable already has a type, and the value can be converted losslessly into a token of that type, then the type is left unchanged.
- If the variable already has a type, and the value cannot be converted losslessly into a token of that type, then the type is changed to that of the current value being set.

If the type of a variable is changed after having once been set, the container is notified of this by calling its `attributeTypeChanged()` method. If the container does not allow type changes, it should throw an exception in this method. If the value is changed after having once been set, then the container is notified of this by calling its `attributeChanged()` method. If the new value is unacceptable to the container, it should throw an exception. The old value will be restored.

The token returned by `getToken()` is always of the type given by the `getType()` method. This is not necessarily the same as the type of the token that was inserted via `setToken()`. It might be a distinct

type if the contained token can be converted losslessly into one of the type given by `getType()`. In rare circumstances, you may need to directly access the contained token without any conversion occurring. To do this, use `getContainedToken()`.

9.4.3 Dependencies

Expressions set by `setExpression()` can reference any other variable that is within scope. By default, the scope includes all variables contained by the same container, and all variables contained by the container's container. In addition, any variable can be explicitly added to the scope of a variable by calling `addToScope()`.

When an expression for one variable refers to another variable, then the value of the first variable obviously depends on the value of the second. If the value of the second is modified, then it is important that the value of the first reflects the change. This dependency is automatically handled. When you call `getToken()`, the expression will be reevaluated if any of the referenced variables have changed values since the last evaluation.

9.5 Expressions

Ptolemy II includes a simple but extensible expression language. This language permits operations on tokens to be specified in a scripting fashion, without requiring compilation of Java code. The expression language can be used to define parameters in terms of other parameters, for example. It can also be used to provide end-users with actors that compute a user-specified expression that refers to inputs and parameters of the actor.

9.5.1 The Ptolemy II Expression Language

Arithmetic operators. The arithmetic operators are `+`, `-`, `*`, `/`, and `%`. These operators, along with `==`, are overloaded¹, so their implementation depends on the types being operated on. Operator overloading is achieved using the methods in the Token classes. These methods are `add()`, `subtract()`, `multiply()`, `divide()`, `modulo()`, and `equals()`.

Bit manipulation. The bitwise operators are `&`, `|`, `^` and `~`. They operate on integers.

Relational operators. The relational operators are `<`, `<=`, `>`, `>=`, `==` and `!=`. They return booleans.

Logical operators. The logical boolean operators are `&&`, `||`, `!`, `&` and `|`. They operate on booleans and return booleans. Note that the difference between logical `&&` and logical `&` is that `&` evaluates all the operands regardless of whether their value is now irrelevant. Similarly for logical `||` and `|`. This approach is borrowed from Java.

Conditionals. The language is an expression language, not an imperative language with sequentially executed statements. Thus, it makes no sense to have the usual `if...then...else...` construct.

1. The Ptolemy II expression language uses operator overloading, unlike Java. Although we fully agree that the designers of Java made a good decision in omitting operator overloading, our expression language is used in situations where compactness of expressions is extremely important. Expressions often appear in crowded dialog boxes in the user interface, so we cannot afford the luxury of replacing operators with method calls. It is more compact to say `"2*(PI + 2i)"` rather than `"2.multiply(PI.add(2i))"`, although both will work in the expression language.

Such a construct in Java (and most imperative languages) depends on side effects. However, Java does have a functional version of this construct (one that returns a value). The syntax for this is

```
boolean ? value1 : value2
```

If the boolean is true, `value1` is returned, else `value2` is returned. The Ptolemy II expression language uses this same syntax.

Comments. Anything inside `/*...*/` is ignored.

Variables. Expressions can contain references by name to parameters within the *scope* of the expression. Consider a parameter *P* with container *X* which is in turn contained by *Y*. The scope of an expression for *P* includes all the parameters contained by *X* and *Y*. The scope is implemented as an instance of `NamedList`, which provides a symbol table. Note that a class derived from `Parameter` may define scope differently.

Constants. If an identifier is encountered in an expression that does not match a parameter in the scope, then it might be a constant that has been registered as part of the language. By default, the constants *PI*, *pi*, *E*, *e*, *true*, *false*, *i*, and *j* are registered, but as we will see later, this can easily be extended. (The constants *i* and *j* are complex numbers with value equal to $0.0 + 1.0i$). In addition, literal string constants are supported. Anything between quotes, "...", is interpreted as a string constant. Numerical values without decimal points, such as "10" or "-3" are integers. Numerical values with decimal points, such as "10.0" or "3.14159" are doubles. Integers followed by the character "l" (el) or "L" are long integers.

Arrays. Arrays are specified with curly brackets. E.g., "{ 1, 2, 3}" is an array of integers, while "{ "x" , "y" , "z" }" is an array of strings. An array is an ordered list of tokens of any type, with the only constraint being that the elements all have the same type. Thus, for example, "{ 1, 2.3}" is illegal because the first element is an integer and the second is a double. The elements of the array can be given by expressions, as in the example "{ 2*pi, 3*pi}." Arrays can be nested; for example, "{ { 1, 2}, { 3, 4, 5} }" is an array of arrays of integers.

Matrices. Matrices are specified with square brackets, using commas to separate row elements and semicolons to separate rows. E.g., "[1, 2, 3; 4, 5, 5+1]" gives a two by three integer matrix (2 rows and 3 columns). Note that an array or matrix element can be given by an expression. A row vector can be given as "[1, 2, 3]" and a column vector as "[1; 2; 3]". Some Matlab-style array constructors are supported. For example, "[1:2:9]" gives an array of odd numbers from 1 to 9, and is equivalent to "[1, 3, 5, 7, 9]". Similarly, "[1:2:9; 2:2:10]" is equivalent to "[1, 3, 5, 7, 9; 2, 4, 6, 8, 10]".

Matrix references. Reference to matrices have the form "*name*(*n*, *m*)" where *name* is the name of a matrix variable in scope (or a constant matrix), *n* is the row index, and *m* is the column index. Index numbers start with zero, as in Java, not 1, as in Matlab.

Records. A record token is a composite type where each element is named, and each element can have a distinct type. Records are delimited by curly braces, with each element given a name. For example, "{ a=1, b="foo" }" is a record with two elements, named "a" and "b", with values 1 (an integer) and "foo" (a string), respectively. The value of a record element can be an arbitrary expression, and records can be nested (an element of a record token may be a record token).

Functions. The language includes an extensible set of functions, such as `sin()`, `cos()`, etc. The functions that are built in include all static methods of the `java.lang.Math` class and the `ptolemy.data.expr.Utility-Functions` class. This can easily be extended by registering another class that includes static methods. The functions currently available are shown in figures 9.4 and 9.5, with the argument types and return

function	argument type(s)	return type	description
abs	double	double	absolute value
abs	int	int	absolute value
abs	long	long	absolute value
acos	double	double	arc cosine
asin	double	double	arc sine
atan	double	double	arc tangent
atan2	double, double	double	angle of a vector
ceil	double	double	ceiling function
cos	double	double	cosine
exp	double	double	exponential function (e^{argument})
floor	double	double	floor function
IEEEremainder	double, double	double	remainder after division
log	double	double	natural logarithm
max	double, double	double	maximum
max	int, int	int	maximum
max	long, long	long	maximum
min	double, double	double	minimum
min	int, int	int	minimum
min	long, long	long	minimum
pow	double, double	double	first argument to the power of the second
random		double	random number between 0.0 and 1.0
rint	double	double	round to the nearest integer
round	double	long	round to the nearest integer
sin	double	double	sine function
sqrt	double	double	square root
tan	double	double	tangent function
toDegrees	double	double	convert radians to degrees
toRadians	double	double	convert degrees to radians

FIGURE 9.4. Functions available to the expression language from the `java.lang.Math` class.

types¹.

One slightly subtle function is the `random()` function. It takes no arguments, and hence is written “`random()`”. It returns a random number. However, this function is evaluated only when the expression within which it appears is evaluated. The result of the expression may be used repeatedly without re-evaluating the expression. The `random()` function is not called again. Thus, for example, if the *value* parameter of the `Const` actor is set to “`random()`”, then its output will be a random constant; i.e., it will not change on each firing.

Methods. Every element and subexpression in an expression represents an instance of `Token` (or more likely, a class derived from `Token`). The expression language supports invocation of any method of a given token, as long as the arguments of the method are of type `Token` and the return type is `Token` (or a class derived from `Token`, or something that the expression parser can easily convert to a token, such as a string, double, int, etc.). The syntax for this is `(token).name(args)`, where *name* is the name of the method and *args* is a comma-separated set of arguments. Each argument can itself be an expression. Note that the parentheses around the *token* are not required, but might be useful for clarity. As an example, the `ArrayToken` class has a `getElement(int)` method, which can be used as follows:

```
{1, 2, 3}.getElement(1)
```

This returns the integer 2. Another useful function of array token is illustrated by the following example:

```
{1, 2, 3}.length()
```

which returns the integer 3.

The `MatrixToken` classes have three particularly useful methods, illustrated in the following examples:

```
[1, 2; 3, 4; 5, 6].getRowCount()
```

which returns 3, and

function	argument type(s)	return type	description
gaussian	double, double	double	Gaussian random variable with the specified mean, and standard deviation
gaussian	double, double, int, int	double matrix	Gaussian random matrix with the specified mean, standard deviation, rows, and columns

FIGURE 9.5. Functions available to the expression language from the `ptolemy.data.expr.Utility-Functions` class. This class is still at a preliminary stage, and the function it provides will grow over time.

1. At this time, in release 1.0, the types must match exactly for the expression evaluator to work. Thus, “`sin(1)`” fails, because the argument to the `sin()` function is required to be a double.

```
[1, 2; 3, 4; 5, 6].getColumnCount()
```

which returns 2, and

```
[1, 2; 3, 4; 5, 6].toArray()
```

which returns {1, 2, 3, 4, 5, 6}. The latter function can be particularly useful for creating arrays using Matlab-style syntax. For example, to obtain an array with the integers from 1 to 100, you can enter:

```
[1:1:100].toArray()
```

The `get()` method of `RecordToken` accesses a record field, as in the following example:

```
{a=1, b=2}.get("a")
```

which returns 1.

Types. The types currently supported in the language are boolean, complex, fixed point, double, int, long, arrays, matrices, records, and string. Note that there is no float or byte. Use double or int instead. A long is defined by appending an integer with “l” (lower case L) or “L”, as in Java. A complex is defined by appending an “i” or a “j” to a double for the imaginary part. This gives a purely imaginary complex number which can then leverage the polymorphic operations in the `Token` classes to create a general complex number. Thus “2 + 3i” will result in the expected complex number. A fixed point number is defined using the “fix” function, as will be explained below in section 9.6.4.

The `Token` classes from the data package form the primitives of the language. For example the number 10 becomes an `IntToken` with the value 10 when evaluating an expression. Normally this is invisible to the user. The expression language is object-oriented, of course, so methods can be invoked on these primitives. A sophisticated user, therefore, can make use of the fact that “10” is in fact an object to invoke methods of that object.

In particular, the `convert()` method of the `Token` class might be useful, albeit a bit subtle in how it is used. For example:

```
(1.2).convert(1)
```

creates a `DoubleToken` with value 1.2, and then invokes its `convert()` method with argument 1, which is an `IntToken`. The `convert()` method of `DoubleToken` converts the argument to a `DoubleToken`, so the result of this expression is (somewhat surprisingly) 1.0. The `convert()` method supports only lossless type conversion (see section 9.3.2). Lossy conversion has to be done explicitly via a function call.

The expression language is extensible. The basic mechanism for extension is object-oriented. The reflection package in Java is used to recognize method invocations and user-defined constants. We also expect the language to grow over time, so this description should be viewed as a snapshot of its capabilities.

9.5.2 Limitations

The expression language has a rich potential, and only some of this potential has been realized. Here are some of the current limitations:

- The class `ptolemy.data.util.UtilityFunctions` containing the utility functions has not yet been fully written.
- Functions in the math package need to be supported in much the same way that `java.lang.Math` is supported.
- Method calls are currently only allowed on tokens in the `ptolemy.data` package.
- Statements are not supported. It is not clear that they ever will be, since currently the expression language is strictly functional, and converting it to imperative semantics could drastically change its flavor.

9.6 Fixed Point Data Type

Ptolemy II includes a preliminary fixed point data type. The `FixPoint` class in the math package represents fixed point numbers. The `FixToken` class encapsulates fixed point data for exchange between Ptolemy II actors. The precision of fixed point data is denoted in two different ways:

(m/n) : The total precision of the output is m bits, with the integer part having n bits. The fractional part thus has $m - n$ bits.

$(m.n)$: The total precision of the output is $n + m$ bits, with the integer part having m bits, and the fractional part having n bits.

We represent a fixed point value in the expression language using the following format:

```
fix(value, integerBits, fractionBits)
```

Thus, a fixed point value of 5.375 that uses 8 bit precision of which 4 bits are used to represent the integer part can be represented as:

```
fix(5.375, 8, 4)
```

These functions are implemented by the `FixPointFunctions` class in the `ptolemy.data.expr` package. The value can also be a matrix of doubles. The values are rounded, yielding the nearest value representable with the specified precision. If the value to represent is out of range, then it is saturated, meaning that the maximum or minimum fixed point value is returned, depending on the sign of the specified value. For example,

```
fix(5.375, 8, 3)
```

will yield 3.968758, the maximum value possible with the $(8/3)$ precision.

In addition to the `fix()` function, the expression language offers a `quantize()` function. The arguments are the same as those of the `fix()` function, but the return type is a `DoubleToken` or `DoubleMatrixToken` instead of a `FixToken` or `FixMatrixToken`. This function can therefore be used to quantize

double-precision values without ever explicitly working with the fixed-point representation.

9.6.1 FixPoint Implementation

We will now discuss how the `FixPoint` data type is implemented in Ptolemy II, and how it interacts with the `Token` types and expression parser. The overall UML diagram showing classes involved in the definition of the `FixPoint` data type is shown in Figure 9.6

9.6.2 FixPoint

The `FixPoint` type is written from scratch and it uses at its core the Java package *BigInteger* to represent the finite precision value that is captured in a `FixPoint`. The advantage of using the *BigInteger* package is that it makes this `FixPoint` implementation truly platform independent and furthermore, it doesn't put any restrictions on the maximal number of bits allowed to represent a value.

The `FixPoint` data type uses an innerclass to represent the *BigInteger*. The innerclass is used to keep track of errors as they may occur. These errors are that an overflow or rounding condition occurred. The innerclass keeps the *BigInteger* and error messages together. Besides the *BigInteger* package, the `FixPoint` class also relies on the *BigDecimal* package when converting values from `FixPoints` to doubles and vice versa.

The precision used in the `FixPoint` data type is represented by class `Precision`. This class does the parsing and validation of the various specification styles we want to support. It stores a precision into two separate integers. One number represents the number of integer bits, and the other number represents the number of fractional bits.

A `FixPoint` is created by supplying a *BigInteger* and a `Precision`. This seems to be an odd way of creating `FixPoints`. That is because the preferred way to create a `FixPoint` is to use one of the static quantizer functions in class *Quantizer*. By selecting either the *round* or the *truncate* method, a different quantizer is chosen to convert a double into a `FixPoint`.

To change the precision of a `FixPoint`, you have to use the specific implementation of *round* and *truncate*. If the change of precision can be accommodated, the `FixPoint` value isn't changed. If the change cannot be accommodated, then precision is changed and an overflow or quantization error may occur. The way the overflow error is handled is determined by a mode switch.

mode = 0, **Saturate**: The fixed point value is set, depending on its sign, equal to the Maximum or Minimum value possible with the new given precision.

mode = 1, **Zero Saturate**: The fixed point value is set equal to zero.

9.6.3 FixToken

A `FixToken` is realized by encapsulating a value of the `FixPoint` type and by implementing all methods of super class `Token` using the methods available for `FixPoint`. Because `FixToken` is derived from `Token` and `ScalarToken`, it can consequently be used in every data type polymorphic actors. In a similar way data type `FixMatrixToken` is created. It encapsulates an two-dimensional array of fixed point values.

The `FixToken` class implements all the methods of `Token` and `ScalarToken`. However, one specific methods has been added: *convertToDouble*. The *convertToDouble* method converts a fixed point value into a double representation. The *getDouble* method defined by `Token` cannot be used since the con-

version from a `FixPoint` to a double is not lossless and an exception will be thrown when tried.

9.6.4 Expression Language

To make the `FixToken` accessible within the expression language, we have added a number of fixed point specific utility functions. These functions have been registered with the expression parser, using its function registration mechanism.

- To create a single `FixPoint` Token using the expression language:

```
fix(5.34, 10, 4)
```

This will create a `FixToken`. In this case, we try to fit the number 5.34 into a 10 bit representation with 4 bits used in the integer part. This may lead to quantization errors. By default the round quantizer is used.

- To create a `Matrix` with `FixPoint` values using the expression language:

```
fix([ -.040609, -.001628, .17853 ], 10, 2)
```

This will create a `FixMatrixToken` with 1 row and 3 columns, in which each element is a `FixPoint` value with precision (10/2). The resulting `FixMatrixToken` will try to fit each element of the given double matrix into a 10 bit representation with 2 bits used for the integer part. It uses by default the round quantizer.

- To create a single `DoubleToken`, which is the quantized version of the double value given, using the expression language:

```
quantize(5.34, 10, 4)
```

This will create a `DoubleToken`. The resulting `DoubleToken` contains the double value obtained by fitting the number 5.34 into a 10 bit representation with 4 bits used in the integer part. This may lead to quantization errors. By default the round quantizer is used.

- To create a `Matrix` with doubles quantized to a particular precision using the expression language:

```
quantize([ -.040609, -.001628, .17853 ], 10, 2)
```

This will create a `DoubleMatrixToken` with 1 row and 3 columns. The elements of the token are obtained by fitting the given matrix elements into a 10 bit representation with 2 bits used for the integer part. Instead of being a fixed point value, the values are converted back to their double representation and by default the round quantizer is used.

Appendix D: Expression Evaluation

The evaluation of an expression is done in two steps. First the expression is parsed to create an *abstract syntax tree* (AST) for the expression. Then the AST is evaluated to obtain the token to be placed in the parameter. In this appendix, “token” refers to instances of the Ptolemy II token classes, as opposed to lexical tokens generated when an expression is parsed.

D.1 Generating the parse tree

In Ptolemy II the expression parser, called *PtParser*, is generated using JavaCC and JJTree. JavaCC is a compiler-compiler that takes as input a file containing both the definitions of the lexical tokens that the parser matches and the production rules used for generating the parse tree for an expression. The production rules are specified in *Backus normal form* (BNF). JJTree is a preprocessor for JavaCC that enables it to create an AST. The parser definition is stored in the file *PtParser.jjt*, and the generated file is *PtParser.java*. Thus the procedure is

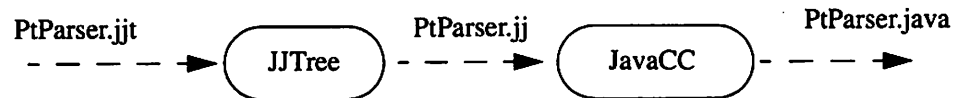

Note that JavaCC generates top-down parsers, or LL(k) in parser terminology. This is different from yacc (or bison) which generates bottom-up parsers, or more formally LALR(1). The JavaCC file also differs from yacc in that it contains both the lexical analyzer and the grammar rules in the same file.

The input expression string is first converted into lexical tokens, which the parser then tries to match using the production rules for the grammar. Each time the parser matches a production rule it creates a node object and places it in the abstract syntax tree. The type of node object created depends on the production rule used to match that part of the expression. For example, when the parser comes upon a multiplication in the expression, it creates an *ASTPtProductNode*.

The parser takes as input a string, and optionally a *NamedList* of parameters to which the input expression can refer. That *NamedList* is the symbol table. If the parse is successful, it returns the root node of the abstract syntax tree (AST) for the given string. Each node object can contain a token, which represents both the type and value information for that node. The type of the token stored in a node, e.g. *DoubleToken*, *IntToken* etc., represents the type of the node. The data value contained by the token is the value information for the node. In the AST as it is returned from *PtParser*, the token types and values are only resolved for the leaf nodes of the tree.

One of the key properties of the expression language is the ability to refer to other parameters by name. Since an expression that refers to other parameters may need to be evaluated several times (when the referred parameter changes), it is important that the parse tree does not need to be recreated every time. When an identifier is parsed, the parser first checks whether it refers to a parameter within the current scope. If it does it creates an *ASTPtLeafNode* with a reference to that parameter. Note that a leaf node can have a parameter or a token. If it has a parameter then when the token to be stored in this node is evaluated, it is set to the token contained by the parameter. Thus the AST tree does not need to be recreated when a referenced parameter changes as upon evaluation it will just get the new token stored in the referenced parameter. If the parser was created by a parameter, the parameter passes in a

reference to itself in the constructor. Then upon parsing a reference to another parameter, the parser takes care of registering the parameter that created it as a listener with the referred parameter. This is how dependencies between parameters get registered. There is also a mechanism built into parameters to detect dependency loops.

If the identifier does not refer to a parameter, the parser then checks if it refers to a constant registered with the parser. If it does it creates a node with the token associated with the identifier. If the identifier is neither a reference to a parameter or a constant, an exception is thrown.

D.2 Evaluating the parse tree

The AST can be evaluated by invoking the method `evaluateParseTree()` on the root node. The AST is evaluated in a bottom up manner as each node can only determine its type after the types of all its children have been resolved. When the type of the token stored in the root node has been resolved, this token is returned as the result of evaluating the parse tree.

As an example consider the input string `2 + 3.5`. The parse tree returned from the parser will look like this:

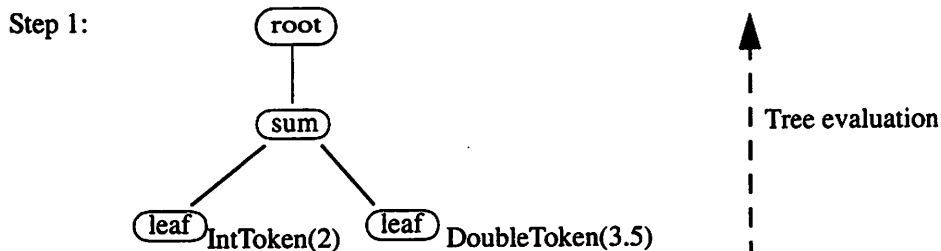

which will then get evaluated to this:

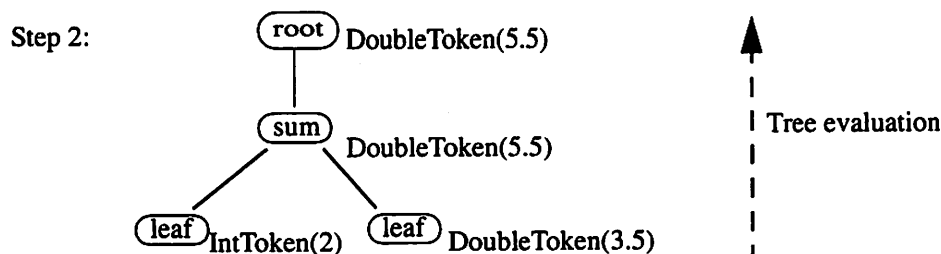

and `DoubleToken(5.5)` will be returned as the result.

As seen in the above example, when `evaluateParseTree()` is invoked on the root node, the type and value of the tokens stored at each node in the tree is resolved, and finally the token stored in the root node is returned. If an error occurs during either the creation of the parse tree or the evaluation of the parse tree, an `IllegalArgumentException` is thrown with a error message about where the error occurred.

If a node has more than two children, type resolution is done pairwise from the left. Thus `"2 + 3 + 'hello'"` resolves to `5hello`. This is the same approach that Java follows.

Each time the parser encounters a function call, it creates an `ASTPtFunctionNode`. When this node is being evaluated, it uses reflection to look for that function in the list of classes registered with the

parser for that purpose. The classes automatically searched are `java.lang.Math` and `ptolemy.data.expr.UtilityFunctions`. To register another class to be searched when a function call is parsed, call `registerFunctionClass()` on the parser with the full name of the class to be added to the function search path.

When a parameter has been informed that another parameter it references changed, the parameter re-evaluates the parse tree for the expression to obtain the new value when `getToken()` is called on the parameter. It is not necessary to parse the expression again as the relevant leaf node stores a reference to the referenced parameter, not the token contained in that parameter. Thus at any use, the value of a parameter is up to date.

D.2.1 Node types

There are currently fourteen node classes used in creating the syntax tree. For some of these nodes the types of their children are fairly restricted and so type and value resolution is done in the node. For others, the operators that they represent are overloaded, in which case methods in the token classes are called to resolve the node type and value (i.e. the contained token). By type resolution we are referring to the type of the token to be stored in the node.

ASTPtBitwiseNode. This is created when a bitwise operation (`&`, `|`, `^`) happens. Type resolution occurs in the node. The `&` and `|` operators are only valid between two booleans, or two integer types. The `^` operator is only valid between two integer types.

ASTPtLeafNode. This represents the leaf nodes in the AST. The parser will always place either a token of the appropriate type (e.g. `IntToken` if “2” is what is parsed) or a parameter in a leaf node. A parameter is placed so that the parse tree can be reevaluated without reparsing whenever the value of the parameter changes. No type resolution is necessary in this node.

ASTPtRootNode. Parent class of all the other nodes. As its name suggests, it is the root node of the AST. It always has only one child, and its type and value is that of its child.

ASTPtFunctionNode. This is created when a function is called. Type resolution occurs in the node. It uses reflection to call the appropriate function with the arguments supplied. It searches the classes registered with the parser for the function. By default it only looks in `java.lang.Math` and `ptolemy.data.expr.UtilityFunctions`.

ASTPtFunctionallfNode. This is created when a functional if is parsed. Type resolution occurs in the node. For a functional if, the first child node must contain a `BooleanToken`, which is used to choose which of the other two tokens of the child nodes to store at this node.

ASTPtMethodCallNode. This is created when a method call is parsed. Method calls are currently only allowed on tokens in the `ptolemy.data` package. All of the arguments to the method, and the return type, must be of type `Token` (or a subclass).

ASTPtProductNode. This is created when a `*`, `/` or `%` is parsed. Type resolution does not occur in the node. It uses the `multiply()`, `divide()` and `modulo()` methods in the token classes to resolve the nodes type.

ASTPtSumNode. This is created when a `+` or `-` is parsed. Type resolution does not occur in the node. It uses the `add()` and `subtract()` methods in the token classes to resolve the nodes type.

ASTPtLogicalNode. This is created when a `&&` or `||` is parsed. Type resolution occurs in the node. All

children nodes must have tokens of type `BooleanToken`. The resolved type of the node is also `BooleanToken`.

ASTPtRelationalNode. This is created when one of the relational operators (`!=`, `==`, `>`, `>=`, `<`, `<=`) is parsed. The resolved type of the token of this node is `BooleanToken`. The “`==`” and “`!=`” operators are overloaded via the `equals()` method in the token classes. The other operators are only valid on `ScalarTokens`. Currently the numbers are converted to doubles and compared, this needs to be adjusted to take account of `Longs`.

ASTPtUnaryNode. This is created when a unary negation operator (`!`, `~`, `-`) is parsed. Type resolution occurs in the node, with the resulting type being the same as the token in the only child of the node.

ASTPtArrayConstructNode. This is created when an array construction sub-expression is parsed.

ASTPtMatrixConstructNode. This is created when a matrix construction sub-expression is parsed.

ASTPtRecordConstructNode. This is created when a record construct sub-expression is parsed.

D.2.2 Extensibility

The Ptolemy II expression language has been designed to be extensible. The main mechanisms for extending the functionality of the parser is the ability to register new constants with it and new classes containing functions that can be called. However it is also possible to add and invoke methods on tokens, or to even add new rules to the grammar, although both of these options should only be considered in rare situations.

To add a new constant that the parser will recognize, invoke the method `registerConstant(String name, Object value)` on the parser. This is a static method so whatever constant you add will be visible to all instances of `PtParser` in the Java virtual machine. The method works by converting, if possible, whatever data the object has to a token and storing it in a hashtable indexed by name. By default, only the constants in `java.lang.Math` are registered.

To add a new Class to the classes searched for a a function call, invoke the method `registerClass(String name)` on the parser. This is also a static method so whatever class you add will be searched by all instances of `PtParser` in the JVM. The name given must be the fully qualified name of the class to be added, for example “`java.lang.Math`”. The method works by creating and storing the `Class` object corresponding to the given string. If the class does not exist an exception is thrown. When a function call is parsed, an `ASTPtFunctionNode` is created. Then when the parse tree is being evaluated, the node obtains a list of the classes it should search for the function and, using reflection, searches the classes until it either finds the desired function or there are no more classes to search. The classes are searched in the same order as they were registered with the parser, so it is better to register those classes that are used frequently first. By default, only the classes `java.Lang.Math` and `ptolemy.data.expr.UtilityFunctions` are searched.

10

Graph Package

*Authors: Jie Liu
Yuhong Xiong*

10.1 Introduction

The Ptolemy II kernel provides extensive infrastructure for creating and manipulating clustered graphs of a particular flavor. Mathematical graphs, however, are simpler structures that consist of nodes and edges, without hierarchy. Edges link only two nodes, and therefore are much simpler than the relations of the Ptolemy II kernel. Moreover, in mathematical graphs, no distinction is made between multiple edges that may be adjacent to a node, so the ports of the Ptolemy II kernel are not needed. A large number of algorithms have been developed that operate on mathematical graphs, and many of these prove extremely useful in support of scheduling, type resolution, and other operations in Ptolemy II. Thus, we have created the *graph* package, which provides efficient data structures for mathematical graphs, and collects algorithms for operating on them. At this time, the collection of algorithms is nowhere near as complete as in some widely used packages, such as LEDA. But this package will serve as a repository for a growing suite of algorithms.

The graph package provides basic infrastructure for both undirected and directed graphs. Acyclic directed graphs, which can be used to model complete partial orders (CPOs) and lattices, are also supported with more specialized algorithms.

The graphs constructed using this package are lightweight, designed for fast implementation of complex algorithms more than for generality. This makes them maximally complementary to the clustered graphs of the Ptolemy II kernel, which emphasize generality. A typical use of this package is to construct a graph that represents the topology of a CompositeEntity, run a graph algorithm, and extract useful information from the result. For example, a graph might be constructed that represents data precedences, and a topological sort might be used to generate a schedule. In this kind of application, the hierarchy of the original clustered graph is flattened, so nodes in the graph represent only opaque entities.

The architecture of this package is somewhat different from LEDA, in part because of the exist-

ence of the complementary kernel package. Unlike LEDA, there are no dedicated classes representing nodes and edges in the graph. The nodes in this package are represented by arbitrary instances of the Java Object class, and the graph topology is stored in a structure similar to an adjacency list.

The facilities that currently exist in this package are those that we have had most immediate need for. Since the type system of Ptolemy II requires extensive operations on lattices and CPOs, support for these is better developed than for other types of graphs.

10.2 Classes and Interfaces in the Graph Package

Figure 10.1 shows the class diagram of the graph package. The classes Graph, DirectedGraph and DirectedAcyclicGraph support graph construction and provide graph algorithms. Currently, only topological sort and transitive closure are implemented; other algorithms will be added as needed. The CPO interface defines the basic CPO operations, and the class DirectedAcyclicGraph implements this interface. An instance of DirectedAcyclicGraph is also a finite CPO where all the elements and order relations are explicitly specified. Defining the CPO operations in an interface allows future expansion to support infinite CPOs and finite CPOs where the elements are not explicitly enumerated. The Ine-

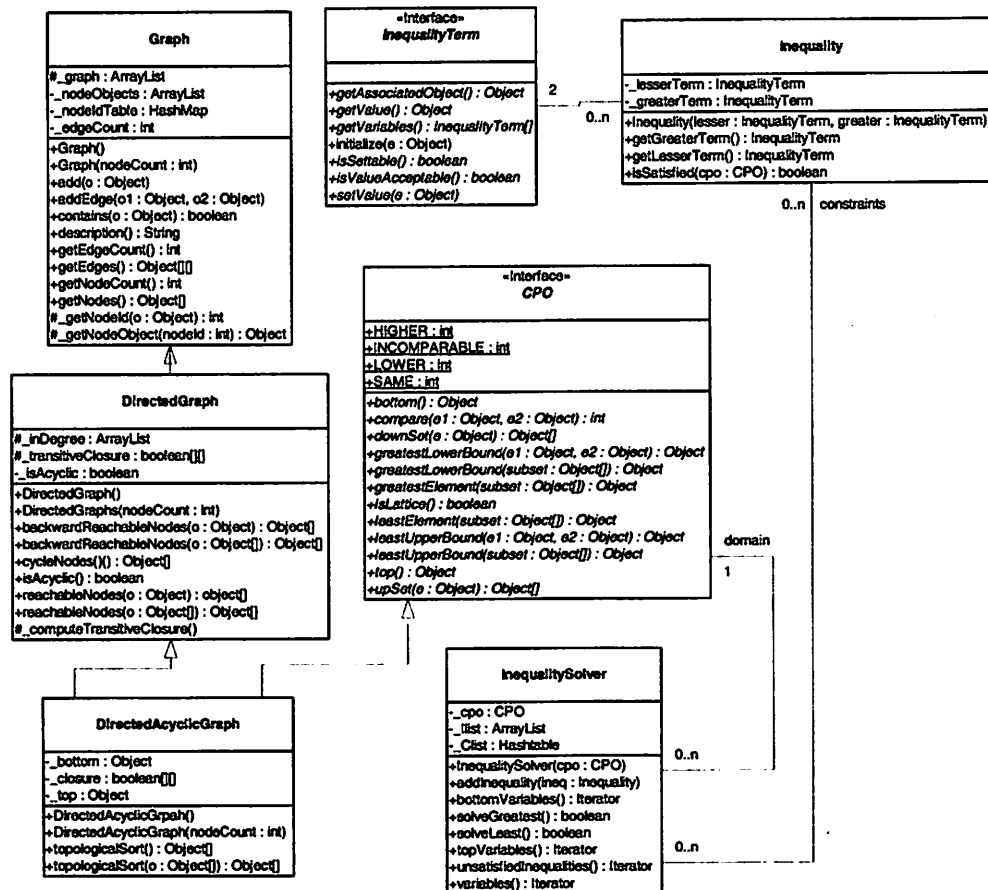

FIGURE 10.1. Classes in the graph package

qualityTerm interface and the Inequality class model inequality constraints over the CPO. The details of the constraints will be discussed later. The InequalitySolver class provides an algorithm to solve a set of constraints. This is used by the Ptolemy II type system, but other uses may arise.

The implementation of the above classes is not synchronized. If multiple threads access a graph or a set of constraints concurrently, external synchronization will be needed.

10.2.1 Graph

This class models a simple undirected graph. Each node in the graph is represented by an arbitrary Java object. The method `add()` is used to add a node to the graph, and `addEdge()` is used to connect two nodes in the graph. The arguments of `addEdge()` are two Objects representing two nodes already added to the graph. To mirror a topology constructed in the kernel package, multiple edges between two nodes are allowed. Each node is assigned a node ID based on the order the nodes are added. The translation from the node ID to the node Object is done by the `_getNodeObject()` method, and the translation in the other direction is done by `_getNodeId()`. Both methods are protected. The node ID is only used by this class and the derived classes, it is not exposed in any of the public interfaces. The topology is stored in the Vector `_graph`. The indexes of this Vector correspond to node IDs. Each entry of `_graph` is also a Vector, in which a list of node IDs are stored. When an edge is added by calling `addEdge()` with the first argument having node ID i and the second having node ID j , an Integer containing j is added to the Vector at the i -th entry of `_graph`. For example, if the graph in figure 10.2(a) is connected using the sequence of calls: `addEdge(n0, n1)`; `addEdge(n0, n2)`; `addEdge(n2, n1)`, where $n0$, $n1$, $n2$ are Objects representing the nodes with IDs 0, 1, 2, respectively, then the data structure will be in the form of 10.2(b).

Note that in this undirected graph, the data format is dependent on the order of the two arguments in the `addEdge()` calls. Since each edge is stored only once, this data structure is not exactly the same as the adjacency list for undirected graphs, but it is quite similar. This structure is designed to be used by subclasses that model directed graphs, as well as by this base class. If it appears awkward when adding algorithms for undirected graph, a new class that derives from `Graph` may be added in the future to model undirected graph exclusively, in which case, `Graph` will provide the basic support for both undirected and directed graphs.

10.2.2 Directed Graphs

The `DirectedGraph` class is derived from `Graph`. The `addEdge()` method in `DirectedGraph` adds a directed edge to the graph. In this package, the direction of the edge is said to go from a *lower* node to

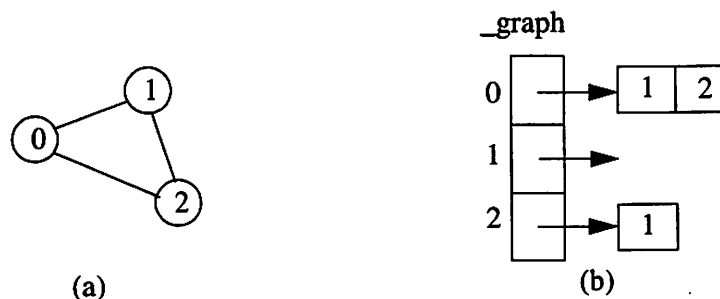

FIGURE 10.2. An undirected graph

a *higher* node, as opposed to from *source* to *sink*, *head* to *tail*, etc. The terms lower and higher conforms with the convention of the graphical representation of CPOs and lattices (the Hasse diagram), so they can be consistently used on both directed graphs and CPOs.

The computation of transitive closure is implemented in this class. The transitive closure is internally stored as a 2-D boolean matrix, whose indexes correspond to node IDs. The entry (i, j) is *true* if and only if there exists a path from the node with ID i to the node with ID j . This matrix is not exposed at the public interface; instead, it is used by this class and its subclass to do other operations. Once the transitive closure matrix is computed, graph operations like *reachableNodes* can be easily accomplished.

10.2.3 Directed Acyclic Graphs and CPO

The *DirectedAcyclicGraph* class further restricts *DirectedGraph* by not allowing cycles. For performance reasons, this requirement is not checked when edges are added to the graph, but is checked when any of the graph operations is invoked. An exception is thrown if the graph is found to be cyclic.

The CPO interface defines the common operations on CPOs. The mathematical definition of these operations can be found in [20]. Informal definitions are given in the class documentation. This interface is implemented by the class *DirectedAcyclicGraph*.

Since most of the CPO operations involve the comparison of two elements, and comparison can be done in constant time once the transitive closure is available, *DirectedAcyclicGraph* makes heavy use of the transitive closure. Also, since most of the operations on a CPO have a dual operation, such as least upper bound and greatest lower bound, least element and greatest element, etc., the code for the dual operations can be shared if the order relation on the CPO is reversed. This is done by transposing the transitive closure matrix.

10.2.4 Inequality Terms, Inequalities, and the Inequality Solver

The *InequalityTerm* interface and *Inequality* and *InequalitySolver* classes supports the construction of a set of inequality constraints over a CPO and the identification of a member of the CPO that satisfies the constraints. A constraint is an inequality defined over a CPO, which can involve constants, variables, and functions. As an example, the following is a set of constraints over the 4-point CPO in figure 10.3:

$$\alpha \leq w$$

$$\beta \leq x \wedge \alpha$$

$$\alpha \leq \beta$$

where α and β are variables, and \wedge denotes greatest lower bound. One solution to this set of constraints is $\alpha = \beta = x$.

An inequality term is either a constant, a variable, or a function over a CPO. The *InequalityTerm*

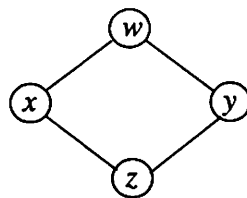

FIGURE 10.3. A 4-point CPO that also happens to be a lattice.

interface defines the operations on a term. If a term consists of a single variable, the value of the variable can be set to a specific element of the underlying CPO. The `isSettable()` method queries whether the value of a term can be set. It returns *true* if the term is a variable, and *false* if it is a constant or a function. The `setValue()` method is used to set the value for variable terms. The `getValue()` method returns the current value of the term, which is a constant if the term consists of a single constant, the current value of a variable if the term consists of a single variable, or the evaluation of a function based on the current value of the variables if the term is a function. The `getVariables()` method returns all the variables contained in a term. This method is used by the inequality solver.

The `Inequality` class contains two `InequalityTerms`, a lesser term and the greater term. The `isSatisfied()` method tests whether the inequality is satisfied over the specified CPO based on the current value of the variables. It returns *true* if the inequality is satisfied, and *false* otherwise.

The `InequalitySolver` class implements an algorithm to determine satisfiability of a set of inequality constraints and to find the solution to the constraints if they are satisfiable. This algorithm is described in [79]. It is basically an iterative procedure to update the value of variables until all the constraints are satisfied, or until conflicts among the constraints are found. Some limitations on the type of constraints apply for the algorithm to work. The method `addInequality()` adds an inequality to the set of constraints. Two methods `solveLeast()` and `solveGreatest()` can be used to solve the constraints. The former tries to find the least solution, while the latter attempts to find the greatest solution. If a solution is found, these methods return *true* and the current value of the variables is the solution. The method `unsatisfiedInequalities()` returns an enumeration of the inequalities that are not satisfied based on the current value of the variables. It can be used after `solveLeast()` or `solveGreatest()` return *false* to find out which inequalities cannot be satisfied after the algorithm runs. The `bottomVariables()` and `topVariables()` methods return enumerations of the variables whose current values are the bottom or the top element of the CPO.

10.3 Example Use

10.3.1 Generating A Schedule for A Composite Actor

The following is an example of using topological sort to generate a firing schedule for a `CompositeActor` of the actor package. The connectivity information among the Actors within the composite is translated into a directed acyclic graph, with each node of the graph represented by an Actor. The schedule is stored in an array, where each element of the array is a reference to an Actor.

```
Object[] generateSchedule(CompositeActor composite) {
    DirectedAcyclicGraph dag = new DirectedAcyclicGraph();
    // Add all the actors contained in the composite to the graph.
    Iterator actors = composite.deepEntityList().iterator();
    while (actors.hasNext()) {
        Actor actor = (Actor)actors.next();
        dag.add(actor);
    }

    // Add all the connection in the composite as graph edges.
    actors = composite.deepEntityList().iterator();
    while (actors.hasNext()) {
        Actor lowerActor = (Actor)actors.next();

        // Find all the actors "higher" than the current one.
        Iterator outPorts = lowerActor.outputPortList().iterator();
        while (outPorts.hasNext()) {
```



```

        IOPort outputPort = (IOPort)outPorts.next();
        Iterator inPorts =
            outputPort.deepConnectedInPortList().iterator();
        while (inPorts.hasNext()) {
            IOPort inputPort = (IOPort)inPorts.next();
            Actor higherActor = (Actor)inputPort.getContainer();
            if (dag.contains(higherActor)) {
                dag.addEdge(lowerActor, higherActor);
            }
        }
    }
}
return dag.topologicalSort();
}

```

10.3.2 Forming and Solving Constraints over a CPO

The code below uses two classes implementing the `InequalityTerm` interface. They model constant and variable terms, respectively. The values of these terms are `Strings`. Inequalities can be formed using these two classes.

```

// A constant InequalityTerm with a String Value.
class Constant implements InequalityTerm {

    // construct a constant term with the specified String value.
    public Constant(String value) {
        _value = value;
    }

    // Return the constant String value of this term.
    public Object getValue() {
        return _value;
    }

    // Constant terms do not contain any variable, so return an array of size zero.
    public InequalityTerm[] getVariables() {
        return new InequalityTerm[0];
    }

    // Constant terms are not settable.
    public boolean isSettable() {
        return false;
    }

    // Throw an Exception on an attempt to change this constant.
    public void setValue(Object e) throws IllegalArgumentException {
        throw new IllegalArgumentException("Constant.setValue: This term is a constant.");
    }

    // the String value of this term.
    private String _value = null;
}

// A variable InequalityTerm with a String value.
class Variable implements InequalityTerm {

    // Construct a variable InequalityTerm with a null initial value.
    public Variable() {
    }

    // Return the String value of this term.
    public Object getValue() {
        return _value;
    }
}

```

```

// Return an array containing this variable term.
public InequalityTerm[] getVariables() {
    InequalityTerm[] variable = new InequalityTerm[1];
    variable[0] = this;
    return variable;
}

// Variable terms are settable.
public boolean isSettable() {
    return true;
}

// Set the value of this variable to the specified String.
// Not checking the type of the specified Object before casting for simplicity.
public void setValue(Object e) throws IllegalArgumentException {
    _value = (String)e;
}

private String _value = null;
}

```

As a simple example, the following Java class constructs the 4-point CPO of figure 10.3, forms a set of constraints with three inequalities, and solves for both the least and greatest solutions. The inequalities are $a \leq w$; $b \leq a$; $b \leq z$, where w and z are constants in figure 2.3, and a and b are variables.

```

// An example of forming and solving inequality constraints.
public class TestSolver {
    public static void main(String[] arv) {
        // construct the 4-point CPO in figure 2.3.
        CPO cpo = constructCPO();

        // create inequality terms for constants w, z and
        // variables a, b.
        InequalityTerm tw = new Constant("w");
        InequalityTerm tz = new Constant("z");
        InequalityTerm ta = new Variable();
        InequalityTerm tb = new Variable();

        // form inequalities: a<=w; b<=a; b<=z.
        Inequality iaw = new Inequality(ta, tw);
        Inequality iba = new Inequality(tb, ta);
        Inequality ibz = new Inequality(tb, tz);

        // create the solver and add the inequalities.
        InequalitySolver solver = new InequalitySolver(cpo);
        solver.addInequality(iaw);
        solver.addInequality(iba);
        solver.addInequality(ibz);

        // solve for the least solution
        boolean satisfied = solver.solveLeast();

        // The output should be:
        // satisfied=true, least solution: a=z b=z
        System.out.println("satisfied=" + satisfied + ", least solution:"
            + " a=" + ta.getValue() + " b=" + tb.getValue());

        // solve for the greatest solution
        satisfied = solver.solveGreatest();

        // The output should be:
        // satisfied=true, greatest solution: a=w b=z
        System.out.println("satisfied=" + satisfied + ", greatest solution:"
            + " a=" + ta.getValue() + " b=" + tb.getValue());
    }

    public static CPO constructCPO() {

```

```
DirectedAcyclicGraph cpo = new DirectedAcyclicGraph();

    cpo.add("w");
    cpo.add("x");
    cpo.add("y");
    cpo.add("z");

    cpo.addEdge("x", "w");
    cpo.addEdge("y", "w");
    cpo.addEdge("z", "x");
    cpo.addEdge("z", "y");

    return cpo;
}
}
```

11

Type System

Authors: Edward A. Lee
Yuhong Xiong
Contributors: Steve Neuendorffer

11.1 Introduction

The computation infrastructure provided by the basic actor classes is not statically typed, i.e., the IOPorts on actors do not specify the type of tokens that can pass through them. This can be changed by giving each IOPort a type. One of the reasons for static typing is to increase the level of safety, which means reducing the number of untrapped errors [17].

In a computation environment, two kinds of execution errors can occur, trapped errors and untrapped errors. Trapped errors cause the computation to stop immediately, but untrapped errors may go unnoticed (for a while) and later cause arbitrary behavior. Examples of untrapped errors in a general purpose language are jumping to the wrong address, or accessing data past the end of an array. In Ptolemy II, the underlying language Java is quite safe, so errors rarely, if ever, cause arbitrary behavior.¹ However, errors can certainly go unnoticed for an arbitrary amount of time. As an example, figure 11.1 shows an imaginary application where a signal from a source is downsampled, then fed to a fast Fourier transform (FFT) actor, and the transform result is displayed by an actor. Suppose the FFT actor can accept ComplexToken at its input, and the behavior of the DownSample actor is to just pass every

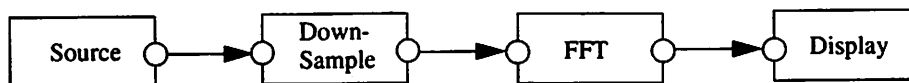

FIGURE 11.1. An imaginary Ptolemy II application

1. Synchronization errors in multi-thread applications are not considered here.

second token through regardless of its type. If the Source actor sends instances of `ComplexToken`, everything works fine. But if, due to an error, the Source actor sends out a `StringToken`, then the `StringToken` will pass through the sampler unnoticed. In a more complex system, the time lag between when a token of the wrong type is sent by an actor and the detection of the wrong type may be arbitrarily long.

In languages without static typing, such as Lisp and the scripting language Tcl, safety is achieved by extensive run-time checking. In Ptolemy II, if we imitated this approach, we would have to require actors to check the type of the received tokens before using them. For example, the FFT actor would have to verify that the every received token is an instance of `ComplexToken`, or convert it to `ComplexToken` if possible. This approach gives the burden of type checking to the actor developers, distracting them from their development effort. It also relies on a policy that cannot be enforced by the system. Furthermore, since type checking is postponed to the last possible moment, the system does not have fail-stop behavior, so a system may generate an error only after running for an extended period of time, as figure 11.1 shows. To make things worse, an actor may receive tokens from multiple sources. If a token with the wrong type is received, it might be hard to identify from which source the token comes. All these make debugging difficult.

To address this and other issues discussed later, we added static typing to Ptolemy II. This approach is consistent with Ptolemy Classic. In general-purpose statically-typed languages, such as C++ and Java, static type checking done by the compiler can find a large fraction of program errors. In Ptolemy II, execution of a model does not involve compilation. Nonetheless, static type checking can correspondingly detect problems before any actors fire. In figure 11.1, if the Source actor declares that its output port type is `String`, meaning that it will send out `StringTokens` upon firing, the static type checker will identify this type conflict in the topology.

In Ptolemy II, because models are not compiled, static typing alone is not enough to ensure type safety at run-time. For example, even if the above Source actor declares its output type to be `Complex`, nothing prevents it from sending out a `StringToken` at run-time. So run-time type checking is still necessary. With the help of static typing, run-time type checking can be done when a token is sent out from a port. I.e., the run-time type checker checks the token type against the type of the output port. This way, a type error is detected at the earliest possible time, and run-time type checking (as well as static type checking) can be performed by the system instead of by the actors.

One design principle of Ptolemy II is that data type conversions that lose information are not implicitly performed by the system. In the data package, a lossless data type conversion hierarchy, called the type lattice, is defined (see figure 9.2). In that hierarchy, the conversion from a lower type to a higher type is lossless, and is supported by the token classes. This lossless conversion principle also applies to data transfer. This means that across every connection from an output port to an input, the type of the output must be the same as or lower than the type of the input. This requirement is called the type compatibility rule. For example, an output port with type `Int` can be connected to an input port with type `Double`, but a `Double` to `Int` connection will generate a type error during static type checking. This behavior is different from Ptolemy Classic, but it should be useful in many applications where the users do not want lossy conversion to take place without their knowledge.

As can be seen from above examples, when a system runs, the type of a token sent out from an output port may not be the same as the type of the input port the token is sent to. If this happens, the token must be converted to the input port type before it is used by the receiving actor. This kind of run-time type conversion is done transparently by the Ptolemy II system (actors are not aware it). So the actors can safely cast the received tokens to the type of the input port. This makes the actor development easier.

Ousterhout [74] argues that static typing discourages reuse.

“Typing encourages programmers to create a variety of incompatible interfaces, each interface requires objects of specific type and the compiler prevents any other types of objects from being used with the interface, even if that would be useful”.

In Ptolemy II, typing does apply some restrictions on the interaction of actors. Particularly, actors cannot be interconnected arbitrarily if the type compatibility rule is violated. However, the benefit of typing should far outweigh the inconvenience caused by this restriction. In addition, the automatic run-time type conversion provided by the system permits ports of different types to be connected (under the type compatibility rule), which partly relaxes the restriction caused by static typing. Furthermore, there is one important component in Ptolemy that brings much flexibility to the actor interface, the type-polymorphic actors.

Type-polymorphic actors (called polymorphic actors in the rest of this chapter) are actors that can accept multiple types on their ports. For example, the `DownSample` in figure 11.1 does not care about the type of token going through it; it works with any type of token. In general, the types on some or all of the ports of a polymorphic actor are not rigidly defined to specific types when the actor is written, so the actor can interact with other actors having different types, increasing reusability. In Ptolemy Classic, the ports on polymorphic actors whose types are not specified are said to have `ANYTYPE`, but Ptolemy II uses the term *undeclared type*, since the type on those ports cannot be arbitrary in general. The acceptable types on polymorphic actors are described by a set of type constraints. The static type checker checks the applicability of a polymorphic actor in a topology by finding specific types for them that satisfy the type constraints. This process is called *type resolution*, and the specific types are called the resolved types.

In addition to ports, Parameters, which are often used to configure actors, are also typed objects. By defining a uniform interface for setting up type constraints, Ptolemy II supports type constraints between Parameters and ports, as well as among ports. This extends the range of type checking to some of the internal states of actors.

Static typing and type resolution have other benefits in addition to the ones mentioned above. Static typing helps to clarify the interface of actors and makes them more manageable. Just as typing may improve run-time efficiency in a general-purpose language by allowing the compiler to generate specialized code, when a Ptolemy system is synthesized to hardware, type information can be used for efficient synthesis. For example, if the type checker asserts that a certain polymorphic actor will only receive `IntTokens`, then only hardware dealing with integers needs to be synthesized.

To summarize, Ptolemy II takes an approach of static typing coupled with run-time type checking. Lossless data type conversions during data transfer are automatically executed. Polymorphic actors are supported through type resolution.

11.2 Formulation

11.2.1 Type Constraints

In a Ptolemy II topology, the type compatibility rule imposes a type constraint across every connection from an output port to an input port. It requires that the type of the output port, *outType*, be the same as the type of the input port, *inType*, or less than *inType* under the type lattice in figure 9.2. I.e.,

$$outType \leq inType \tag{1}$$

This guarantees that information is not lost during data transfer. If both the *outType* and *inType* are declared, the static type checker simply checks whether this inequality is satisfied, and reports a type conflict if it is not.

In addition to the above constraint imposed by the topology, actors may also impose constraints. This happens when one or both of the *outType* and *inType* is undeclared, in which case the actor containing the undeclared port needs to describe the acceptable types through type constraints. All the type constraints in Ptolemy II are described in the form of inequalities like the one in (1). If a port has a declared type, its type appears as a constant in the inequalities. On the other hand, if a port has an undeclared type, its type is represented by a variable, called the type variable, in the inequalities. The domain of the type variable is the elements of the type lattice. The type resolution algorithm resolves the undeclared types subject to the constraints. If resolution is not possible, a type conflict error will be reported. As an example of the inequality constraints, consider figure 11.2.

The port on actors A1 has declared type *int*; the ports on A3 and A4 have declared type *double*; and the ports on A2 have their types undeclared. Let the type variables for the undeclared types be α , β , and γ , the type constraints from the topology are:

$$\begin{aligned} int &\leq \alpha \\ double &\leq \beta \\ \gamma &\leq double \end{aligned}$$

Now, assume A2 is a polymorphic adder, capable of doing addition for integer, double, and complex numbers, and the requirement is that it does not lose precision during the operation. Then the type constraints for the adder can be written as:

$$\begin{aligned} \alpha &\leq \gamma \\ \beta &\leq \gamma \\ \gamma &\leq Complex \end{aligned}$$

The first two inequalities constrain the output precision to be no less than input, the last one requires that the data on the adder ports can be converted to *Complex* losslessly.

These six inequalities form the complete set of constraints and are used by the type resolution algorithm to solve for α , β , and γ .

This inequality formulation is inspired by the type inference algorithm in ML [66]. There, equalities are used to represent type constraints. In Ptolemy II, the lossless type conversion hierarchy naturally implies inequality relation among the types. In ML, the type constraints are generated from program constructs. In a heterogeneous graphical programming environment like Ptolemy II, the system does not have enough information about the function of the actors, so the actors must present their

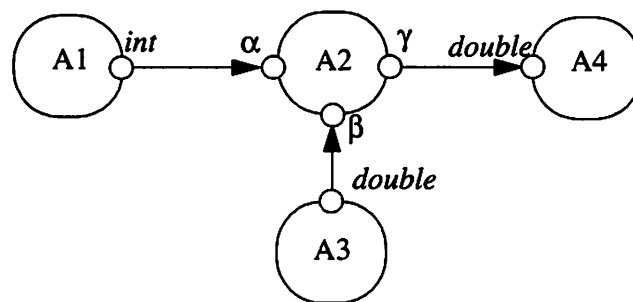

FIGURE 11.2. A topology with types.

type information by either declaring the type on their port, or specify a set of type constraints to describe the acceptable types on the undeclared ports.

This formulation converts type resolution into a problem of solving a set of inequalities. An efficient algorithm is available to solve constraints in finite lattices [79], which is described in the appendix through an example and in figure 11.3. This algorithm finds the set of most specific types for the undeclared types in the topology that satisfy the constraints, if they exist.

As mentioned earlier, the static type checker flags a type conflict error if the type compatibility rule is violated on a certain connection. There are other kind of type conflicts indicated by one of the following:

- The set of type constraints are not satisfiable.
- Some type variables are resolved to *NaT*.
- Some type variables are resolved to an abstract type, such as *Numerical* in the type hierarchy.

The first case can happen, for example, if the port on actor A1 in figure 11.2 has declared type *Complex*. The second case can happen if an actor does not specify any type constraints on an undeclared output port. This is due to the nature of the type resolution algorithm where it assigns all the undeclared types to *NaT* at the beginning. If the type constraints do not restrict a type variable to be greater than *NaT*, it will stay at *NaT* after resolution. The third case is considered a conflict since an

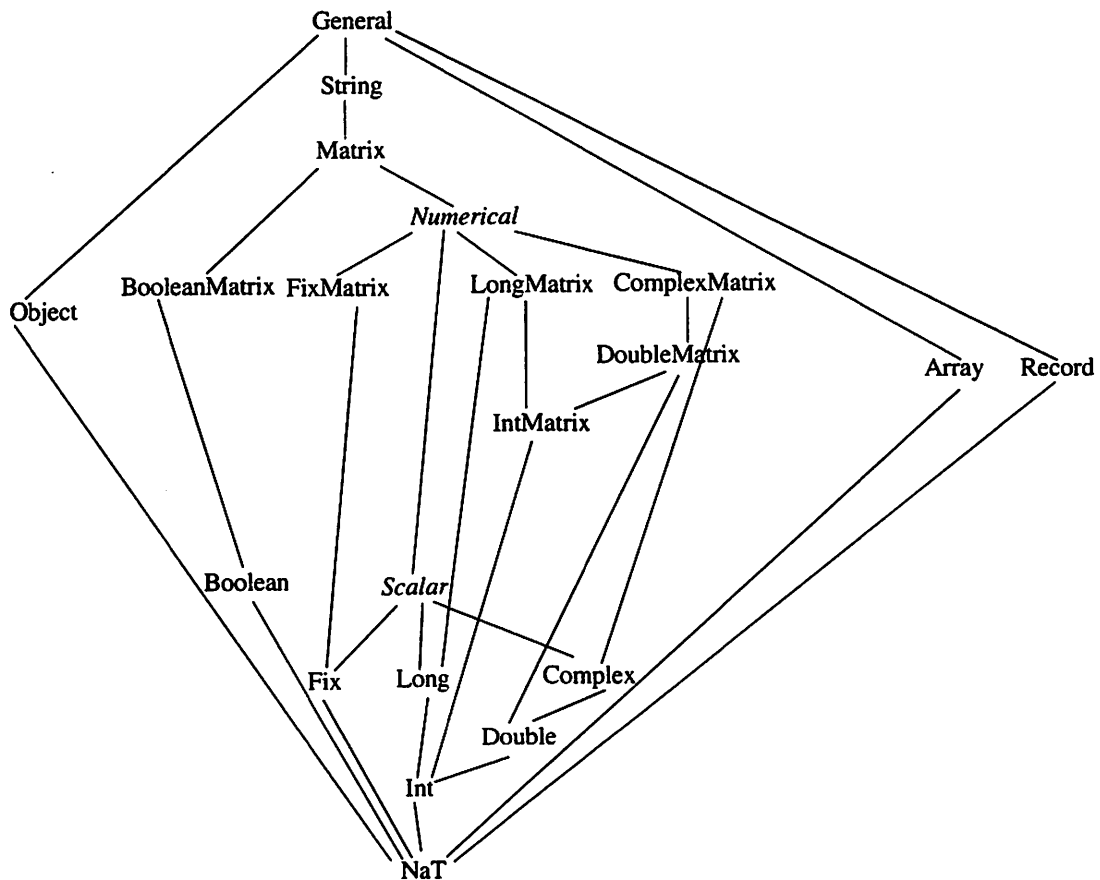

FIGURE 11.3. The Type Lattice

abstract type does not correspond to an instantiable token class.

To avoid the second case above, any output port must either have a declared type, or some constraints to force its type to be greater than *NaT*. This requirement should be easily satisfied on most actors. A situation that needs some attention is the source actor. A source actor cannot leave its output port type unconstrained. One way to cope with this is to declare the type at a time after the type information is known, but prior to type resolution. For example, if the output data is determined by a parameter set by the user, the parameter can be evaluated during the initialization phase of the execution and the port type can be declared at the end of the initialization, which precedes type resolution.

11.2.2 Run-time Type Checking and Lossless Type Conversion

The declared type is a contract between an actor and the Ptolemy II system. If an actor declares an output port to have a certain type, it asserts that it will only send out tokens whose types are less than or equal to that type. If an actor declares an input port to have a certain type, it requires the system to only send tokens that are instances of the class of that type to that input port. Run-time type checking is the component in the system that enforces this contract. When a token is sent out from an output port, the run-time type checker finds its type using the run-time type identification (RTTI) capability of the underlying language (Java), and compares the type with the declared type of the output port. If the type of the token is not less than or equal to the declared type, a run-time type error will be generated.

As discussed before, type conversion is needed when a token sent to an input port has a type less than the type of the input port but is not an instance of the class of that type. Since this kind of lossless conversion is done automatically, an actor can safely cast a received token to the declared type. On the other hand, when an actor sends out tokens, the tokens being sent do not have to have the exact declared output port type. Any type that is less than the declared type is acceptable. For example, if an output port has declared type *double*, the actor can send *IntToken* from that port. As can be seen, the automatic type conversion simplifies the input/output handling of the actors.

Note that even with the convenience provided by the type conversion, actors should still declare the input types to be the most general that they can handle and the output types to be the most specific type that includes all tokens they will send. This maximizes their applications. In the previous example, if the actor only sends out *IntToken*, it should declare the output type to be *int* to allow the port to be connected with an input with type *int*.

If an actor has ports with undeclared types, its type constraints can be viewed as both a requirement and an assertion from the actor. The actor requires the resolved types to satisfy the constraints. Once the resolved types are found, they serve the role of declared types at run time. I.e., the type checking and type conversion system guarantees to only put tokens that are instances of the class of the resolved type to input ports, and the actor asserts to only send tokens whose types are less than or equal to the resolved type from output ports.

11.3 Structured Types

Structured types include array and record types. The Array type is implemented by *ArrayToken*. As described in the Data Package chapter, *ArrayToken* contains an array of tokens, and the element tokens can have arbitrary type. For example, an *ArrayToken* can contain an array of *StringTokens*, or an array of *ArrayTokens*. In the latter case, the *ArrayToken* can be regarded as a two dimensional array. *RecordToken* contains a set of labeled tokens, like the structure in the C language. It is useful for grouping multiple pieces of related information together.

In the type lattice in figure 11.3, array and record types are incomparable with all the base types, except the top and the bottom elements of the lattice. Note that the lattice nodes Array and Record actually represent an infinite number of types, so the type lattice becomes infinite.

The order relation between two array types is that type B is less than type A if the element type of B is less than the element type of A . This is a recursive definition if the element types are structured types. For example, $Int\ Array \leq Double\ Array$, $Int\ Array\ Array \leq Double\ Array\ Array$, where $Int\ Array\ Array$ is an array of array. And $Int\ Array$ and $Double\ Array\ Array$ are incomparable.

The order relation between two record types follow the standard depth subtyping and width subtyping relations [17]. In depth subtyping, a record type C is a subtype of a record type D if the type of some fields of C is a subtype of the corresponding fields in D . In width subtyping, a record with more fields is a subtype of a record with less fields. For example, we have:

```
{name: String, value: Int} ≤ {name: String, value: Double}
{name: String, value: Double, id: Int} ≤ {name: String, value: Double}
```

Here, we use the {label: type, label: type, ...} syntax to denote record types.

Type constraints can be specified between the element type of a structured type and the type of a Ptolemy object. For example, a type constraint can specify that the type of a port is no less than the type of the elements of an ArrayToken.

11.4 Implementation

11.4.1 Implementation Classes

All the classes for representing the types and the type lattice are under the `data.type` package, as shown in figure 11.4. The `Type` interface defines the basic operations on a type. `BaseType` contains a type-safe enumeration of all the primitive types. The type `UNKNOWN` corresponds to the bottom element of the type lattice, it represents a type variable that can be resolved to any type. `ArrayType` and `RecordType` are derived from an abstract class `StructuredType`. Each type has a `convert()` method to convert a token lower in the type lattice to one of its type. For base types, this method just calls the same method in the corresponding tokens. For structured types, the conversion is done within the concrete structured type classes.

The `Typeable` interface defines a set of methods to set type constraints between typed objects. It is implemented by the `Variable` class in the `data.expr` package and the `TypedIOPort` class in the `actor` package. `TypeConstant` encapsulate a constant type. It implements the `InequalityTerm` interface and can be used to set up type constraints between a typed object and a constant type.

In the `actor` package, the `Actor` interface, the `AtomicActor`, `CompositeActor`, `IOPort` and `IORelation` classes are extended with `TypedActor`, `TypedAtomicActor`, `TypedCompositeActor`, `TypedIOPort` and `TypedIORelation`, respectively, as shown in figure 11.5. The container for `TypedIOPort` must be a `ComponentEntity` implementing the `TypedActor` interface, namely, `TypedAtomicActor` or `TypedCompositeActor`. The container for `TypedAtomicActor` and `TypedCompositeActor` must be a `TypedCompositeActor`. `TypedIORelation` constrains that `TypedIOPort` can only be connected with `TypedIOPort`. `TypedIOPort` has a declared type and a resolved type. Undeclared type is represented by `BaseType.UNKNOWN`. If a port has a declared type that is not `BaseType.UNKNOWN`, the resolved type will be the same as the declared type.

11.4.2 Type Checking and Type Resolution

Static type checking is done in the checkTypes() method of TypedCompositeActor. This method finds all the connection within the composite by first finding the output ports on deep contained entities, and then finding the deeply connected input ports to those output ports. Transparent ports are ignored for type checking. For each connection, if the types on both ends are declared, static type

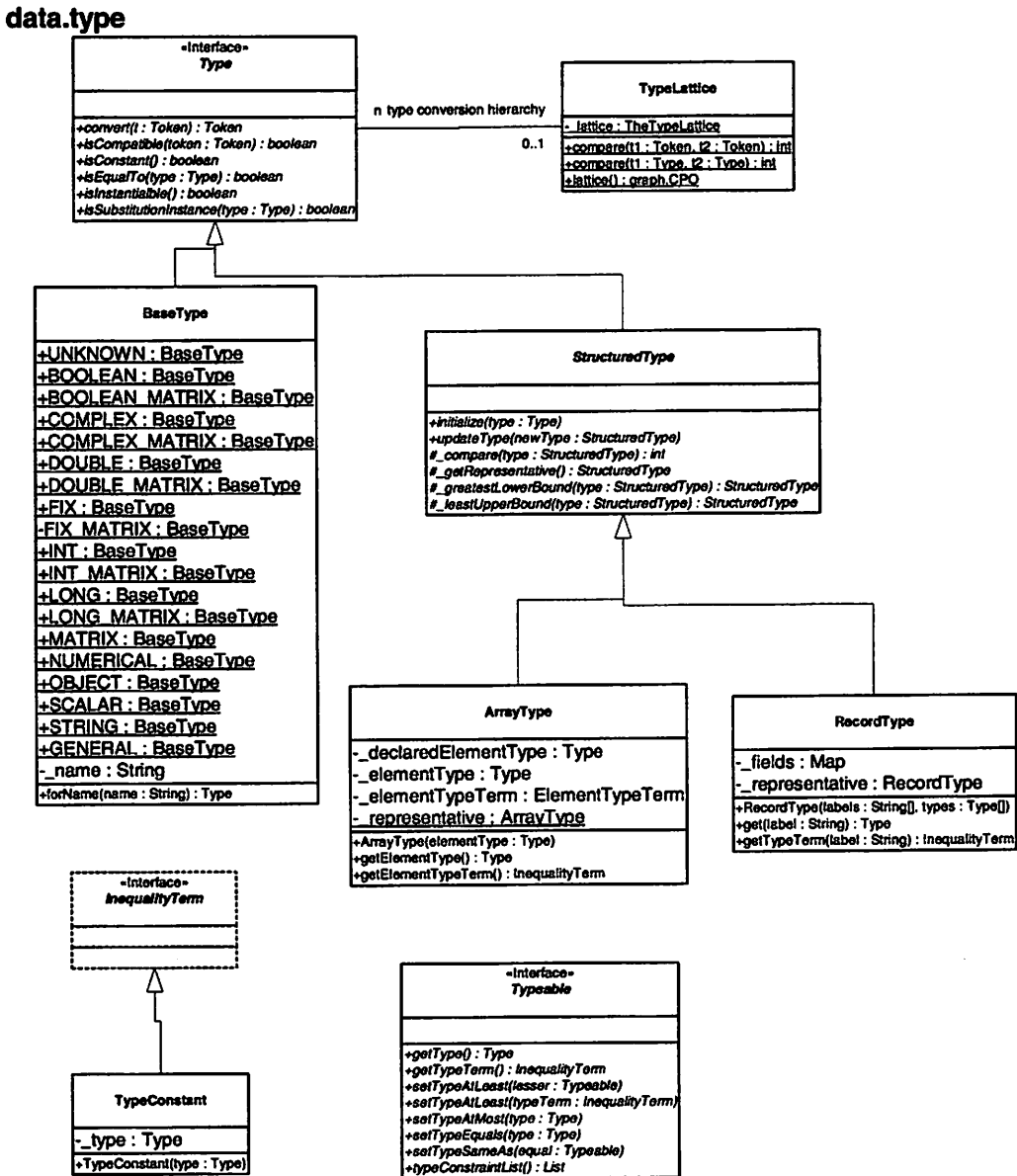

FIGURE 11.4. Classes in the data.type package.

the connection are recorded and will be returned in a List at the end of type checking. Note that type checking does not stop after detecting the first type conflict, so the returned List contains all the ports that have type conflicts. This behavior is similar to a regular compiler, where compilation will generally continue after detecting errors in the source code.

The TypedActor interface has a typeConstraints() method, which returns the type constraints of this actor. For atomic actors, the type constraints are different in different actors, but the TypedAtomicActor class provides a default implementation, which is that the type of any input port with undeclared type must be less than or equal to the type of any undeclared output port. Ports with declared types are not included in the default constraints. If all the ports have declared type, no constraints are generated. This default works for most of the control actors such as commutator, multiplexer, and the DownSample actor in figure 11.1. In addition, the typeConstraints() method also collects all the constraints from the contained Typeable objects, which are TypedIOPorts and Variables.

The typeConstraints() method in TypedCompositeActor collects all the constraints within the composite. It works in a similar fashion as the checkTypes() method, where it recursively goes down the containment hierarchy to collect type constraints of the contained actors. It also scans all the connections and forms type constraints on connections involving undeclared types. As with checkTypes(), if this method is called on the top level container, all the type constraints within the composite are returned.

The Manager class has a resolveTypes() method that invokes type checking and resolution. It uses the InequalitySolver class in the graph package to solve the constraints. If type conflicts are detected during type checking or after type resolution, this method throws TypeConflictException. This exception contains a List of Typeable objects where type conflicts occur. The resolveTypes() method is called inside Manager after all the mutations are processed. If TypeConflictException is thrown, it is caught within the Manager and an KernelException is generated to pass the exception information to the user interface.

Run-time type checking is done in the send() method of TypedIOPort. The checking is simply a comparison of the type of the token being sent with the resolved type of the port. If the type of the token is less than or equal to the resolved type, type checking is passed, otherwise, an IllegalActionException is thrown.

Type conversion, if needed, is also done in the send() method. The type of the destination port is the resolved type of the port containing the receivers that the token is sent to. If the token does not have that type, the convert() method on that type is called to perform the conversion.

11.4.3 Setting Up Type Constraints

The class Inequality in the graph package is used to represent type constraints. This class contains two objects implementing the InequalityTerm interface, which represent the lesser and greater terms. InequalityTerm is implemented by inner classes of TypedIOPort, Variable, ArrayType, and RecordType, to encapsulate the type of the port, the variable, and the element type of structured types. In most cases, type constraints can be set up easily through the methods in the Typeable interface. For example, to constrain that the type of a port to be no greater than *Double*:

```
port.setTypeAtMost(BaseType.DOUBLE);
```

to constrain that the type of a port to be no less than the type of a parameter:

```
port.setTypeAtLeast(parameter);
```

to specify that a parameter can only contain an ArrayToken, and to constrain the type of a port to be no less than the element type of that array:

```
parameter.setTypeEquals(new ArrayType(BaseType.UNKNOWN));
ArrayType arrayType = (ArrayType)parameter.getType();
InequalityTerm elementTerm = arrayType.getElementTypeTerm();
port.setTypeAtLeast(elementTerm);
```

These kinds of constraints appear in source actors such as `Clock` and `Pulse`, where the actor outputs a sequence of values specified by an `ArrayToken`.

In some actors, monotonic functions can help specify less straightforward constraints. The type resolution algorithm allows the lesser term to be a monotonic function when searching for the most specific types. That is, constraints in the form $f(\alpha) \leq b$ are admitted, where $f(\alpha)$ is a monotonic function of α and b can be a constant or a variable. An example of this appears in the `AbsoluteValue` actor in the actor library. Here, one of the type constraints is: If the input type is not *Complex*, the output type is the same as the input type, otherwise, the output type is *Double*. This constraint can be expressed as $f(\text{inputType}) \leq \text{outputType}$, where

$$\begin{aligned} f(\text{inputType}) &= \text{inputType}, & \text{if } \text{inputType} \neq \text{Complex} \\ f(\text{inputType}) &= \text{Double}, & \text{if } \text{inputType} = \text{Complex}. \end{aligned}$$

This function is implemented by an inner class `FunctionTerm` of `AbsoluteValue` that implements `InequalityTerm`. The evaluation is done in the `getValue()` method of `InequalityTerm` as:

```
public Object getValue() {
    // _port is the input port
    Type inputType = _port.getType();
    return inputType == BaseType.COMPLEX ? BaseType.DOUBLE : inputType;
}
```

Finally, if the methods in `Typeable` are not sufficient for specifying complicated constraints, or the default implementation of the `typeConstraints()` method in the `TypedAtomicActor` is not appropriate, this method can be overridden, but this is rarely needed.

11.4.4 Some Implementation Details

The implementation of the structured types is more involved than the base types. This is because the base types are atomic, but structured types that contain type variables are mutable entities. For example, the declared type of a port can be *UNKNOWN Array*, meaning that it is an array of undefined element type. After type resolution, that type may be updated to *Double Array*. Types that are mutable are variable types. The `isConstant()` method in `Type` determines if a type contains a type variable. Type variables are represented by a type initialized to `BaseType.UNKNOWN`.

When a typed object is cloned, if its type is a variable structured type, that type must be cloned because the original and the cloned `Typeable` objects may have different types in the future. Similarly, when constructing structured types with variable structured types as element types, the element types must be cloned. However, constant structured types do not need to be cloned. This means that an instance of a constant `StructuredType` can be shared by many objects, but an instance of a variable `StructuredType` can only have one user. One way to support this is to have bidirectional references between a variable structured type and its user, and only allow the type to have one user. But the bidi-

rectional references make the implementation complicated, and consistency is hard to maintain. A better way is to always clone the structured type when its container is cloned, or when constructing a new instance of `StructuredType`. This is done in the data package. This implementation incurs some redundant cloning, but the overhead is small.

A variable type can be updated to another type, provided that the new type is compatible with the variable type. For example, a type variable α can be updated to any type, α *Array* can be updated to *Int Array*. However, α *Array* cannot be updated to *Int*. If a variable type can be updated to a new type, the new type is called a substitution instance of the variable type. This term is borrowed from type literature. Formally, a type is a substitution instance of a variable type if the former can be obtained by substituting the type variables of the latter to another type. The method `isSubstitutionInstance()` in `Type` does this check.

The `updateType()` method in `StructuredType` is used to change the variable element type of a structured type. For example, if the types of two ports are *Int Array* and α *Array* respectively, and a type constraint is that the second port is no less than the type of the first, that is, $\text{Int Array} \leq \alpha$ *Array*, the type resolution algorithm will change the type of the second port to *Int Array*. This step cannot be done by simply changing the type reference in the second port to an instance of *Int Array*, since type constraints may be set up between α and another typed objects. Instead, `updateType()` only changes the type reference for α to *Int*.

11.5 Examples

11.5.1 Polymorphic DownSample

In figure 11.1, if the `DownSample` is designed to do downsampling for any kind of token, its type constraint is just $\text{samplerIn} \leq \text{samplerOut}$, where *samplerIn* and *samplerOut* are the types of the input and output ports, respectively. The default type constraints works in this case. Assuming the `Display` actor just calls the `toString()` method of the received tokens and displays the string value in a certain window, the declared type of its port would be *General*. Let the declared types on the ports of `FFT` be *Complex*, the The type constraints of this simple application are:

```
sourceOut ≤ samplerIn
samplerIn ≤ samplerOut
samplerOut ≤ Complex
Complex ≤ General
```

Where *sourceOut* represents the declared type of the `Source` output. The last constraint does not involve a type variable, so it is just checked by the static type checker and not included in type resolution. Depending on the value of *sourceOut*, the ports on the `DownSample` actor would be resolved to different types. Some possibilities are:

- If *sourceOut* = *Complex*, the resolved types would be *samplerIn* = *samplerOut* = *Complex*.
- If *sourceOut* = *Double*, the resolved types would be *samplerIn* = *samplerOut* = *Double*. At runtime, *DoubleTokens* sent out from the `Source` will be passed to the `DownSample` actor unchanged. Before they leave the `Downsample` actor and are sent to the `FFT` actor, they are converted to *ComplexTokens* by the system. The *ComplexToken* output from the `FFT` actor are instances of *Token*, which corresponds to the *General* type, so they are transferred to the input of the `Display` without change.

- If $sourceOut = String$, the set of type constraints do not have a solution, a `typeConflictException` will be thrown by the static type checker.

11.5.2 Fork Connection

Consider two simple topologies in figure 11.6. where a single output is connected to two inputs in 11.6(a) and two outputs are connected to a single input in 11.6(b). Denote the types of the ports by $a1$, $a2$, $a3$, $b1$, $b2$, $b3$, as indicated in the figure. Some possibilities of legal and illegal type assignments are:

- In 11.6(a), if $a1 = Int$, $a2 = Double$, $a3 = Complex$. The topology is well typed. At run-time, the `IntToken` sent out from actor A1 will be converted to `DoubleToken` before transferred to A2, and converted to `ComplexToken` before transferred to A3. This shows that multiple ports with different types can be interconnected as long as the type compatibility rule is obeyed.
- In 11.6(b), if $b1 = Int$, $b2 = Double$, and $b3$ is undeclared. The resolved type for $b3$ will be `Double`. If $b1 = int$ and $b2 = Boolean$, the resolved type for $b3$ will be `String` since it is the lowest element in the type hierarchy that is higher than both `Int` and `Boolean`. In this case, if the actor B3 has some type constraints that require $b3$ to be less than `String`, then type resolution is not possible, a type conflict will be signaled.

11.6 Actors Constructing Tokens with Structured Types

The SDF domain contains two actors that perform conversion between a sequence of tokens and an `ArrayToken`. Type constraints in these actors ensure that the type of the array element is the same as the type of the sequence tokens. When two `SequenceToArray` actors are cascaded, the output of the second actor will be an array of array. Cascading `ArrayToSequence` with `SequenceToArray` restores the sequence. In `SequenceToArray`, the parameter `TokenConsumptionRate` of the input port determines the length of the output array, while in `ArrayToSequence`, the parameter `tokenProductionRate` of the output port specifies the length of the input array. If the `ArrayToken` received by `ArrayToSequence` does not have the correct length, an exception will be thrown.

The `actor.lib` package contains two actors that assemble and disassembles `RecordTokens`: `RecordAssembler` and `RecordDisassembler`. The former assembles tokens from multiple input ports into a `RecordToken` and sends it to the output port, the latter does the reverse. The labels in the `RecordToken` are the names of the input ports. Type constraints ensure that the type of the record fields is the same as

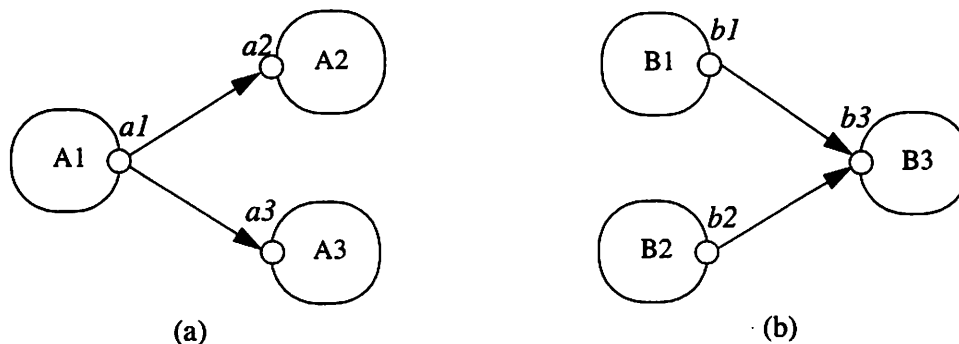

FIGURE 11.6. Two simple topologies with types.

the type of the corresponding ports.

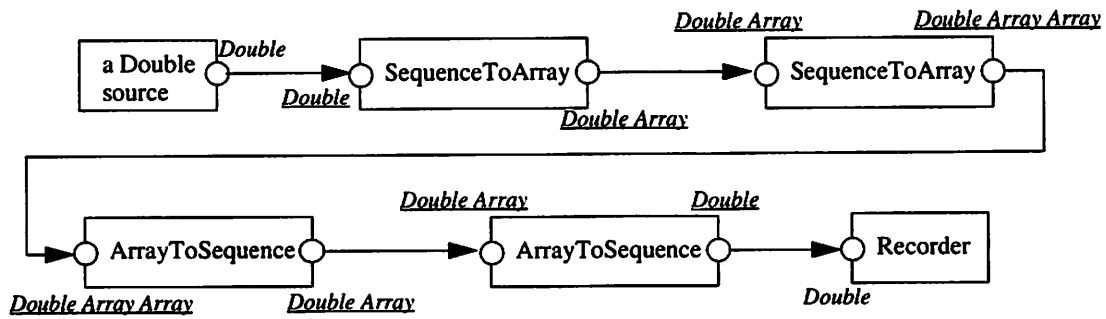

FIGURE 11.7. Conversion between sequence and array.

Appendix E: The Type Resolution Algorithm

The type resolution algorithm starts by assigning all the type variables the bottom element of the type hierarchy, NaT , then repeatedly updating the variables to a greater element until all the constraints are satisfied, or when the algorithm finds that the set of constraints are not satisfiable. The kind of inequality constraints the algorithm can determine satisfiability are the ones with the greater term (the right side of the inequality) being a variable, or a constant. The algorithm allows the left side of the inequality to contain monotonic functions of the type variables, but not the right side. The first step of the algorithm is to divide the inequalities into two categories, $Cvar$ and $Ccst$. The inequalities in $Cvar$ have a variable on the right side, and the inequalities in $Ccst$ have a constant on the right side. In the example of figure 11.2, $Cvar$ consists of:

$$\begin{aligned} Int &\leq \alpha \\ Double &\leq \beta \\ \alpha &\leq \gamma \\ \beta &\leq \gamma \end{aligned}$$

And $Ccst$ consists of:

$$\begin{aligned} \gamma &\leq Double \\ \gamma &\leq Complex \end{aligned}$$

The repeated evaluations are only done on $Cvar$, $Ccst$ are used as checks after the iteration is finished, as we will see later. Before the iteration, all the variables are assigned the value NaT , and $Cvar$ looks like:

$$\begin{aligned} Int &\leq \alpha(NaT) \\ Double &\leq \beta(NaT) \\ \alpha(NaT) &\leq \gamma(NaT) \\ \beta(NaT) &\leq \gamma(NaT) \end{aligned}$$

Where the current value of the variables are inside the parenthesis next to the variable.

At this point, $Cvar$ is further divided into two sets: those inequalities that are not currently satisfied, and those that are satisfied:

Not-satisfied	Satisfied
$Int \leq \alpha(NaT)$	$\alpha(NaT) \leq \gamma(NaT)$
$Double \leq \beta(NaT)$	$\beta(NaT) \leq \gamma(NaT)$

Now comes the update step. The algorithm takes out an arbitrary inequality from the Not-satisfied set, and forces it to be satisfied by assigning the variable on the right side the least upper bound of the values of both sides of the inequality. Assuming the algorithm takes out $int \leq \alpha(NaT)$, then

$$\alpha = Int \vee NaT = Int \tag{2}$$

After α is updated, all the inequalities in $Cvar$ containing it are inspected and are switched to either the Satisfied or Not-satisfied set, if they are not already in the appropriate set. In this example, after this step, $Cvar$ is:

Not-satisfied	Satisfied
$Double \leq \beta(NaT)$	$Int \leq \alpha(Int)$
$\alpha(Int) \leq \gamma(NaT)$	$\beta(NaT) \leq \gamma(NaT)$

The update step is repeated until all the inequalities in $Cvar$ are satisfied. In this example, β and γ

will be updated and the solution is:

$$\alpha = Int, \beta = \gamma = Double$$

Note that there always exists a solution for *Cvar*. An obvious one is to assign all the variables to the top element, *General*, although this solution may not satisfy the constraints in *Cnst*. The above iteration will find the least solution, or the set of most specific types.

After the iteration, the inequalities in *Cnst* are checked based on the current value of the variables. If all of them are satisfied, a solution to the set of constraints is found.

This algorithm can be viewed as repeated evaluation of a monotonic function, and the solution is the fixed point of the function. Equation (2) can be viewed as a monotonic function applied to a type variable. The repeated update of all the type variables can be viewed as the evaluation of a monotonic function that is the composition of individual functions like (2). The evaluation reaches a fixed point when a set of type variable assignments satisfying the constraints in *Cvar* is found.

Rehof and Mogensen [79] proved that the above algorithm is linear time in the number of occurrences of symbols in the constraints, and gave an upper bound on the number of basic computations. In our formulation, the symbols are type constants and type variables, and each constraint contains two symbols. So the type resolution algorithm is linear in the number of constraints.

12

Plot Package

Authors: *Edward A. Lee*
 Christopher Hylands
Contributors: *Lukito Muliadi*
 William Wu
 Jun Wu

12.1 Overview

The plot package provides classes, applets, and applications for two-dimensional graphical display of data. It is available in a stand-alone distribution, or as part of the Ptolemy II system.

There are several ways to use the classes in the plot package:

- You can use one of several domain-polymorphic actors in a Ptolemy II model to plot data that is provided as an input to the actor.
- You can invoke an executable, `ptplot`, which is a shell script, to plot data in a local file or on the network (via a URL).
- You can invoke an executable, `histogram`, which is a shell script, to plot histograms of data in a local file or on the network (via a URL)
- You can invoke an executable, `pxgraph`, which is a shell script, to plot data that is stored in an ascii or binary format compatible with the older program `pxgraph`, which is an extension of David Harrison's `xgraph`.
- You can invoke a Java application, such as `PlotMLApplication`, by using the `java` program that is included in your Java distribution.
- You can use an existing applet class, such as `PlotMLApplet`, in an HTML file. The applet parameter `dataurl` specifies the source of plot data. You do not even have to have `Ptplot` installed on your server, since you can always reference the Berkeley installation.
- You can create new classes derived from `applet`, `frame`, or `application` classes to customize your

plots. This allows you to completely control the placement of plots on the screen, and to write Java code that defines the data to be plotted.

The plot data can be specified in any of three data formats:

- *PlotML* is an XML extension for plot data. Its syntax is similar to that of HTML. XML (extensible markup language) is an internet language that is growing rapidly in popularity.
- An older, simpler textual syntax for plot data is also provided, although in the long term, that syntax is unlikely to be maintained (it will not necessarily be expanded to support new features). For simple data plots, however, it is adequate. Using it for applets has the advantage of making it possible to reference a slightly smaller jar file containing the code, which makes for more responsive applets. Also, the data files are somewhat smaller.
- A binary file format used by *pxgraph*, is supported by classes in the *compat* package. Formatting information in *pxgraph* (and in the *compat* package) is provided by command-line arguments, rather than being included with the binary plot data, exactly as in the older program. Applets specify these command-line arguments as an applet parameter (*pxgraphargs*).

12.2 Using Plots

If *\$PTII* represents the home directory of your plot installation (or your Ptolemy II installation), then, *\$PTII/bin* is a directory that contains a number of executables. Three of these invoke plot applications, *ptplot*, *histogram*, and *pxgraph*. We recommend putting this directory into your path so that these executables can be found automatically from the command line. Invoking the command

```
ptplot
```

with no arguments should open a window that looks like that in figure 12.1. You can also specify a file to plot as a command-line argument. To find out about command-line options, type

```
ptplot -help
```

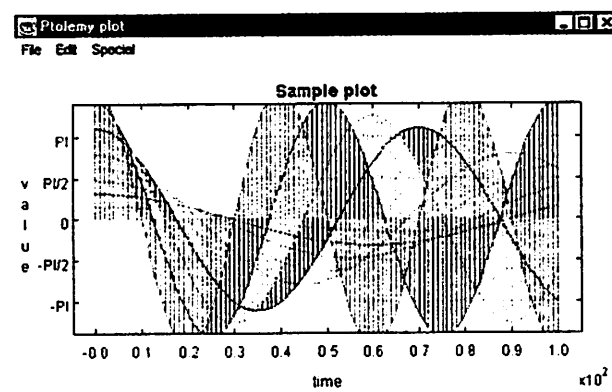

FIGURE 12.1. Result of invoking *ptplot* on the command line with no arguments.

The `ptplot` command is a shell script that invokes the following equivalent command:

```
java -classpath $PTII ptolemy.plot.plotml.EditablePlotMLApplication
```

Since it is a shell script, it will work on Unix machines and Windows machines that have Cygwin¹ installed. In the same directory are three Windows versions that do not require Cygwin, `ptplot.bat`, `histogram.bat`, and `pxgraph.bat`, which you can invoke by typing into the DOS command prompt, for example,

```
ptplot.bat
```

These scripts make three assumptions.

- First, `java` is in your path. Type “`java -version`” to verify that the `java` program is in your path and is working properly
- Second, the environment variable `PTII` is set to point to the home directory of the plot (or Ptolemy II) installation. Type “`echo %PTII%`” in Windows and “`echo $PTII`” in Unix or Windows with Cygwin to check this.
- The directory `$PTII/bin` is in your path. Under Windows without Cygwin, type “`echo %PATH%`”. Type “`type ptplot`” in Windows with Cygwin and “`which ptplot`” in Unix to check this.

In Windows, environment variables and your path are set in the System control panel. You can now explore a number of features of `ptplot`.

12.2.1 Zooming and filling

To zoom in, drag the left mouse button down and to the right to draw a box around an area that you want to see in detail, as shown in figure 12.2. To zoom out, drag the left mouse button up and to the right. To just fill the drawing area with the available data, type `Control-F`, or invoke the fill command from the Special menu. In applets, since there is no menu, the fill command is (optionally) made available as a button at the upper right of the plot.

12.2.2 Printing and exporting

The File menu includes a Print and Export command. The Print command works as you expect. The export command produces an encapsulated PostScript file (EPS) suitable for inclusion in word processors. The image in figure 12.3 is such an EPS file imported into FrameMaker.

At this time, the EPS file does not include preview data. This can make it somewhat awkward to work with in a word processor, since it will not be displayed by the word processor while editing (it will, however, print correctly). It is easy to add the preview data using the freely available program Ghostview². Just open the file using Ghostview and, under the edit menu, select “Add EPS Preview.”

Export facilities are also available from a small set of key bindings, which permits them to be invoked from applets (which have no menu bar) and from the standalone scripts:

1. The 1.1.x version of the Cygwin Toolkit is a freely available package available from <http://sources.redhat.com/cygwin/>
2. Ghostview is available <http://www.cs.wisc.edu/~ghost/gsview/>

- Control-c: Export the plot to the clipboard.
- D: Dump the plot to standard output.
- E: Export the plot to standard output in EPS format.
- F: Fill the plot.
- H or ?: Display a simple help message.

The encapsulated PostScript (EPS) that is produced is tuned for black-and-white printers. In the future, more formats may supported. Also at this time (JDK 1.3.0 under Windows 2000), Java's interface the clipboard may not work, so Control-C might not accomplish anything. Note further that with applets, you may find it best to click near the title rather than clicking inside the graph itself and then type the command.

Exporting to the clipboard and to standard output, in theory, is allowed for applets, unlike writing to a file. Thus, these key bindings provide a simple mechanism to obtain a high-resolution image of the plot from an applet, suitable for incorporation in a document. However, in some browsers, exporting to standard out triggers a security violation. You can use Sun's appletviewer instead.

12.2.3 Editing the data

You can modify the data that is plotted by first selecting a data set to modify using the Edit menu,

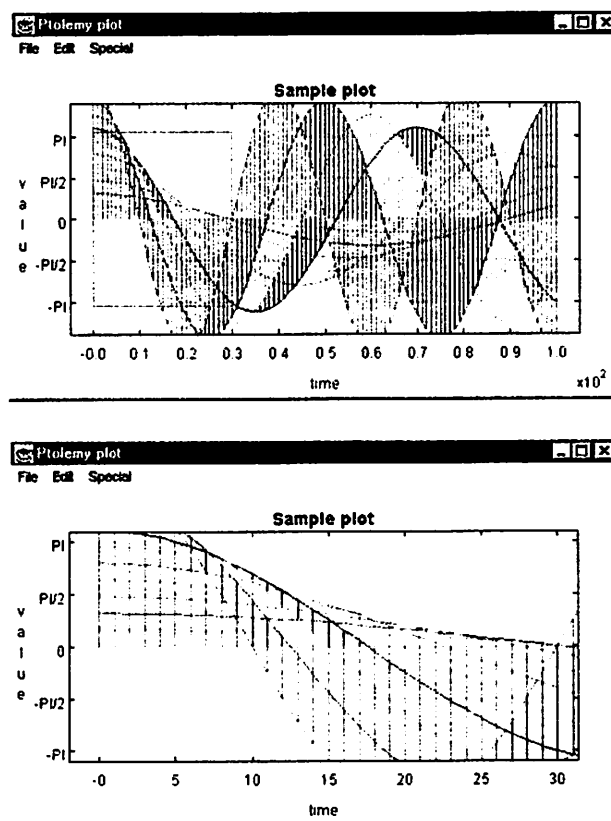

FIGURE 12.2. To zoom in, drag the left mouse button down and to the right to draw a box around the region you wish to see in more detail.

then dragging the right mouse button. Figure 12.4 shows the result of modifying one of the datasets (the one in red on a color display). The modification is carried out by freehand drawing, although considerable precision is possible by zooming in. Use the Save or SaveAs command in the File menu to save the modified plot (in PlotML format).

12.2.4 Modifying the format

You can control how data is displayed by invoking the Format command in the Edit menu. This

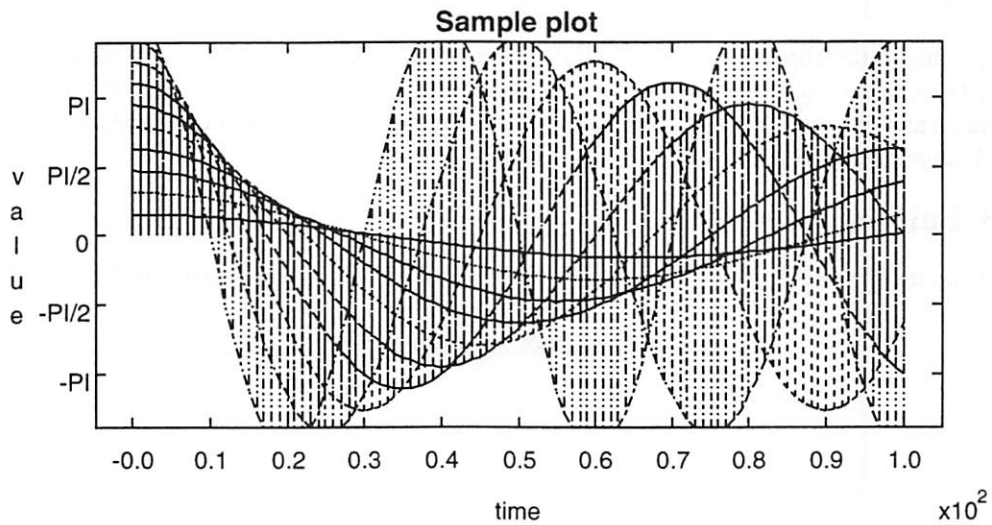

FIGURE 12.3. Encapsulated postscript generated by the Export command in the File menu of *ptplot* can be imported into word processors. This figure was imported into FrameMaker.

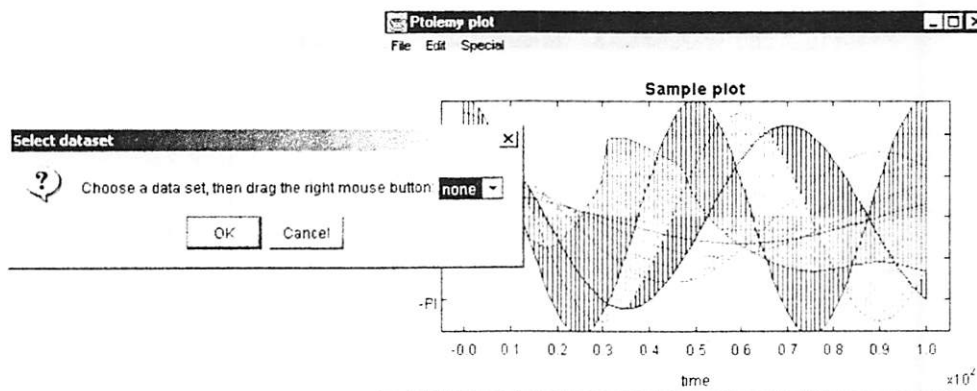

FIGURE 12.4. You can modify the data being plotted by selecting a data set and then dragging the right mouse button. Use the Edit menu to select a data set. Use the Save command in the File menu to save the modified plot (in PlotML format).

brings up a dialog like that at bottom in figure 12.5. At the left is the dialog and the plot before changes are made, and at the right is after changes are made. In particular, the grid has been removed, the stems have been removed, the lines connecting the data points have been removed, the data points have been rendered with points, and the color has been removed. Use the Save or SaveAs command in the File menu to save the modified plot (in PlotML format). More sophisticated control over the plot can be had by editing the PlotML file (which is a text file). The PlotML syntax is described below.

The entries in the format dialog are all straightforward to use except the “X Ticks” and “Y Ticks” entries. These are used to specify how the axes are labeled. The tick marks for the axes are usually computed automatically from the ranges of the data. Every attempt is made to choose reasonable positions for the tick marks regardless of the data ranges (powers of ten multiplied by 1, 2, or 5 are used). To change what tick marks are included and how they are labeled, enter into the “X Ticks” or “Y Ticks” entry boxes a string of the following form:

label position, label position, ...

A *label* is a string that must be surrounded by quotation marks if it contains any spaces. A *position* is a number giving the location of the tick mark along the axis. For example, a horizontal axis for a frequency domain plot might have tick marks as follows:

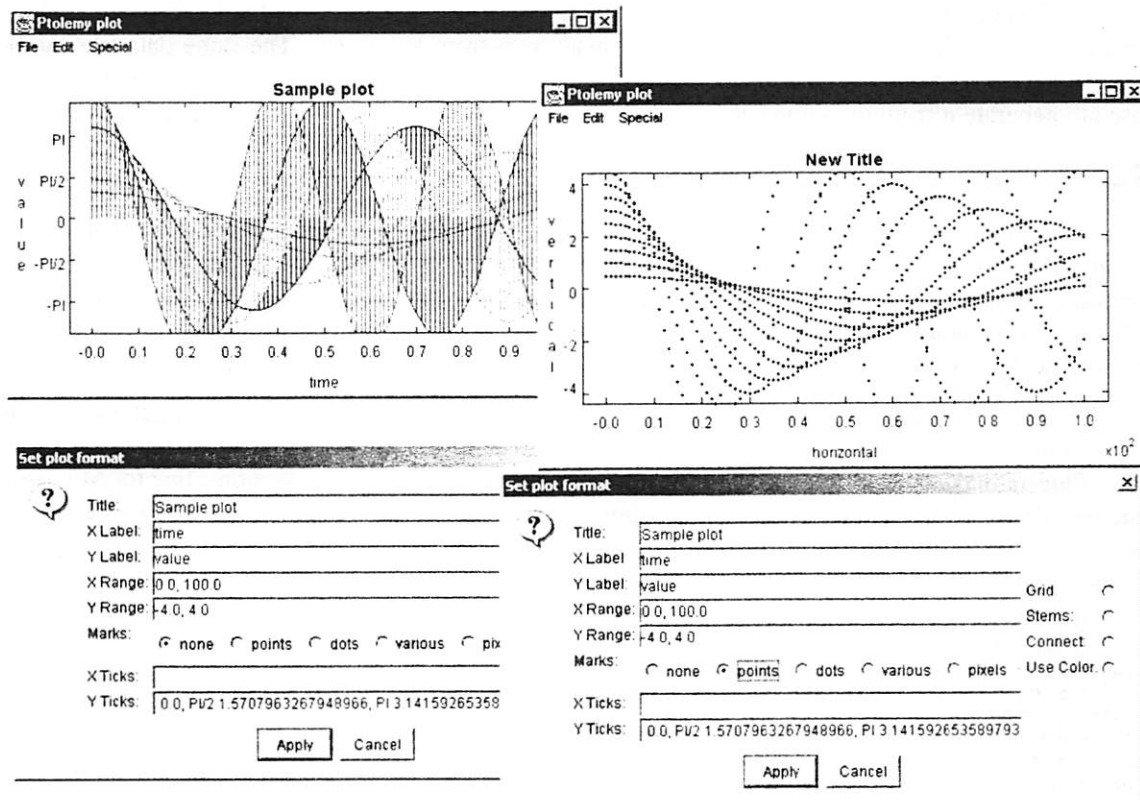

FIGURE 12.5. You can control how data is displayed using the Format command in the Edit menu, which brings up the dialog shown at the bottom. On the left is before changes are made, and on the right is after.

```
XTicks: -PI -3.14159, -PI/2 -1.570795, 0 0, PI/2 1.570795, PI 3.14159
```

Tick marks could also denote years, months, days of the week, etc.

12.3 Class Structure

The plot package has two subpackages, `plotml` and `compat`. The core package, `plot`, contains toolkit classes, which are used in Java programs as building blocks. The two subpackages contain classes that are usable by an end-user (vs. a programmer).

12.3.1 Toolkit classes

The class diagram for the core of the plot package is shown in figure 12.6. These classes provide a toolkit for constructing plotting applications and applets. The base class is `PlotBox`, which renders the axes and the title. It extends `Panel`, a basic container class in Java. Consequently, plots can be incorporated into virtually any Java-based user interface.

The `Plot` class extends `PlotBox` with data sets, which are collections of instances of `PlotPoint`. The `EditablePlot` class extends this further by adding the ability to modify data sets.

Live (animated) data plots are supported by the `PlotLive` class. This class is abstract; a derived class must be created to generate the data to plot (or collect it from some other application).

The `Histogram` class extends `PlotBox` rather than `Plot` because many of the facilities of `Plot` are irrelevant. This class computes and displays a histogram from a data file. The same data file can be read by this class and the other plot classes, so you can plot both the histogram and the raw data that is used to generate it from the same file.

12.3.2 Applets and applications

A number of classes are provided to use the plot toolkit classes in common ways, but you should keep in mind that these classes are by no means comprehensive. Many interesting uses of the plot package involve writing Java code to create customized user interfaces that include one or more plots. The most commonly used built-in classes are those in the `plotml` package, which can read PlotML files, as well as the older textual syntax.

Ptplot 5.1, which shipped with Ptolemy II 1.0 requires Swing. The easiest way to get Swing is to install the Java 1.3 Plug-in, which is part of the JRE and JDK 1.3 installation. Unfortunately, using the Java Plug-in makes the applet HTML more complex. Briefly, there are two sections, one for Microsoft Internet Explorer, the other for Netscape Communicator. The following segment of HTML is an example:

```
<OBJECT classid="clsid:8AD9C840-044E-11D1-B3E9-00805F499D93"
  width="500"
  height="300"
  codebase="http://java.sun.com/products/plugin/1.3/jinstall-13-win32.cab#Version=1,3,0,0">
<PARAM NAME="code"      VALUE="ptolemy.plot.PlotMLApplet">
<PARAM NAME="codebase"  VALUE="../../../../">
<PARAM NAME="archive"   VALUE="ptolemy/plot/plotmlapplet.jar">
<PARAM NAME="type"      VALUE="application/x-java-applet;version=1.3">
<PARAM NAME="background" VALUE="#faf0e6">
<PARAM NAME="dataurl"   VALUE="plot.xml">

<COMMENT>
<EMBED type="application/x-java-applet;version=1.3"
  width="500"
```

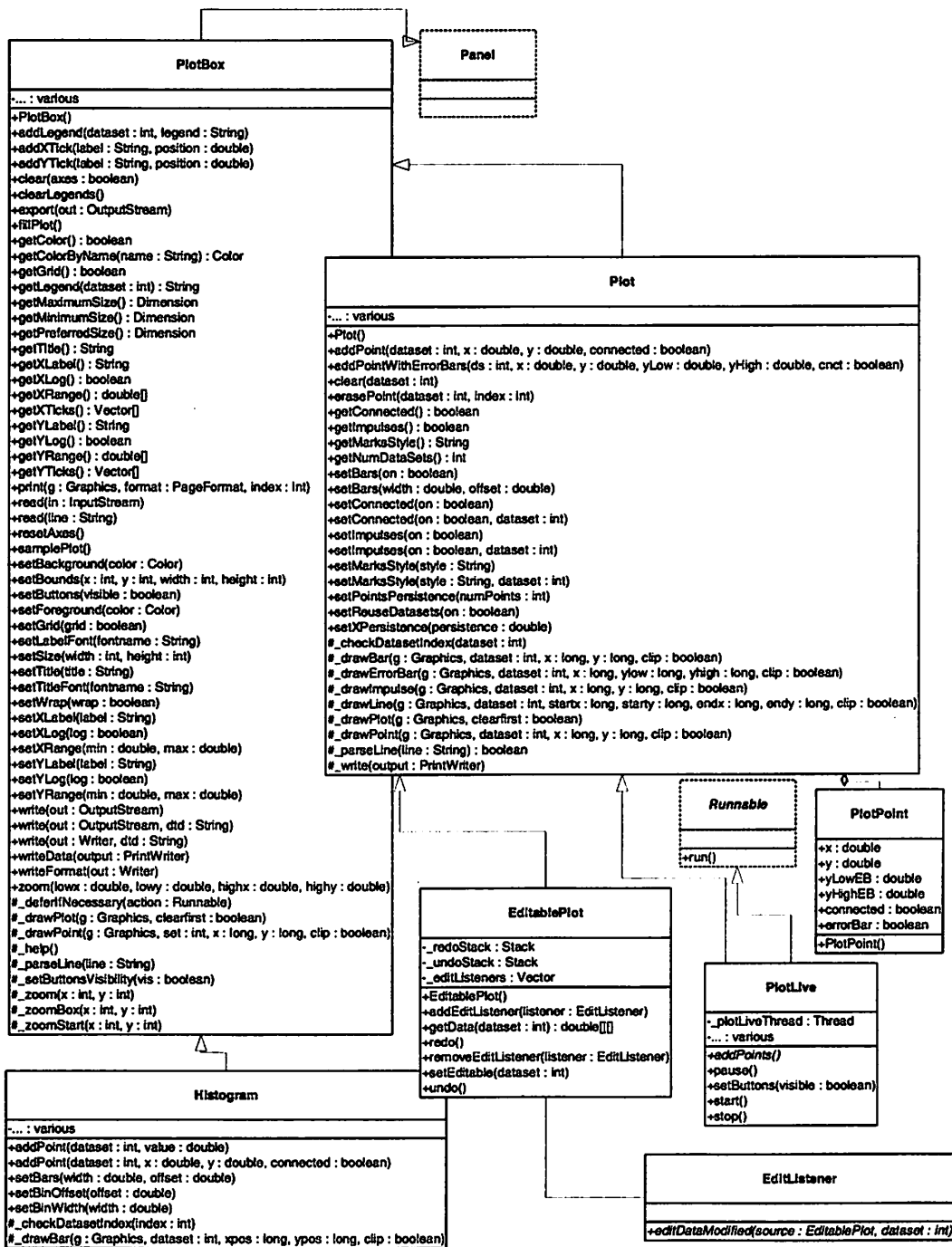

FIGURE 12.6. The core classes of the plot package.

```
height="300"
background="#faf0e6"
code="ptolemy.plot.PlotMLApplet"
codebase="../../../../"
archive="ptolemy/plot/plotmlapplet.jar"
dataurl="sinusoids.xml"
pluginspage="http://java.sun.com/products/plugin/1.3/plugin-install.html">
</COMMENT>
<NOEMBED>
No JDK 1.3 support for applet!
</NOEMBED>
</EMBED>
</OBJECT>
```

To use this yourself you will probably need to change the *codebase* and *dataurl* entries. The first points to the root directory of the plot installation (usually, the value of the PTII environment variable). The second points to a file containing data to be plotted, plus optional formatting information. The file format for the data is described in the next section. The applet is created by instantiating the PlotMLApplet class.

The *archive* entry contains the name of the jar file that contains all the classes necessary to run a PlotML applet. The advantage of specifying a jar file is that remote users are likely to experience a faster download because all the classes come over at once, rather than the browser asking for each class from the server. A downside of using jar files in applets is that if you are modifying the source of Ptolemy itself, then you must also update the jar file, or your changes will not appear. A common workaround is to remove the archive entry during testing.

You can also easily create your own applet classes that include one or more plots. As shown in figure 12.6, the PlotBox class is derived from JPanel, a basic class of the Java Foundation Classes (JFC) toolkit, also known as swing. It is easy to place a panel in an applet, positioned however you like, and to combine multiple panels into an applet. PlotApplet is a simple class that adds an instance of Plot.

Creating an application that includes one or more plots is also easy. The PlotApplication class, shown in figure 12.7, creates a single top-level window (a JFrame), and places within it an instance of Plot. This class is derived from the PlotFrame class, which provides a menu that contains a set of commands, including opening files, saving the plotted data to a file, printing, etc.

The difference between PlotFrame and PlotApplication is that PlotApplication includes a main() method, and is designed to be invoked from the command line. You can invoke it using commands like the following:

```
java -classpath $PTII ptolemy.plot.PlotApplication args
```

However, the classes shown in figure 12.7, which are in the plot package, are not usually the ones that an end user will use. Instead, use the ones in figure 12.8. These extend the base classes to support the PlotML language, described below. The only motivation for using the base classes in figure 12.7 is to have a slightly smaller jar file to load for applets.

The classes that end users are likely to use, shown in figure 12.8, include:

- PlotMLApplet: An applet that can read PlotML files off the web and render them.
- EditablePlotMLApplet: A version that allows editing of any data set in the plot.
- HistogramMLApplet: A version that uses the Histogram class to compute and plot histograms.
- PlotMLFrame: A top-level window containing a plot defined by a PlotML file.
- PlotMLApplication: An application that can be invoked from the command line and reads PlotML

files.

- **EditablePlotMLApplication:** An extension that allows editing of any data set in the plot.
- **HistogramMLApplication:** A version that uses the Histogram class to compute and plot histograms.

EditablePlotMLApplication is the class invoked by the `ptplot` command-line script. It can open plot files, edit them, print them, and save them.

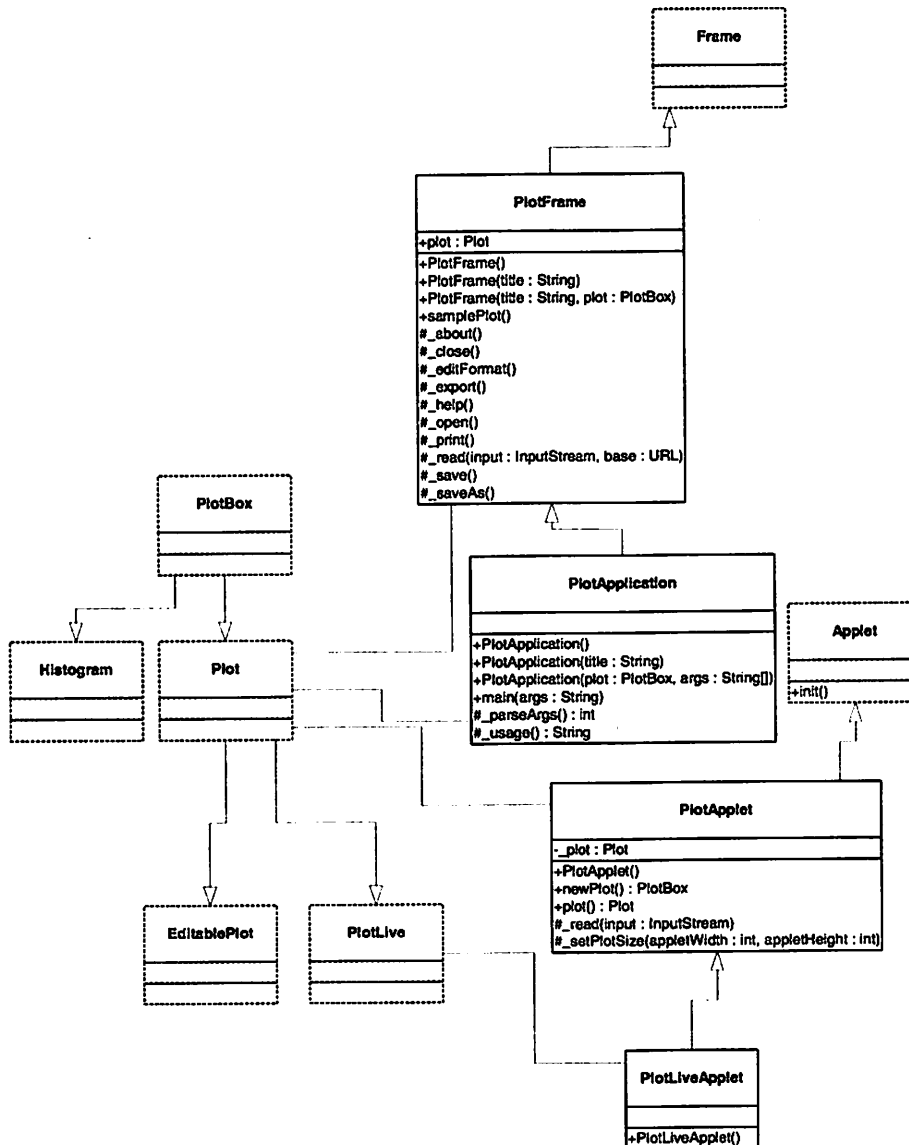

FIGURE 12.7. Core classes supporting applets and applications. Most of the time, you will use the classes in the `plotml` package, which extend these with the ability to read PlotML files.

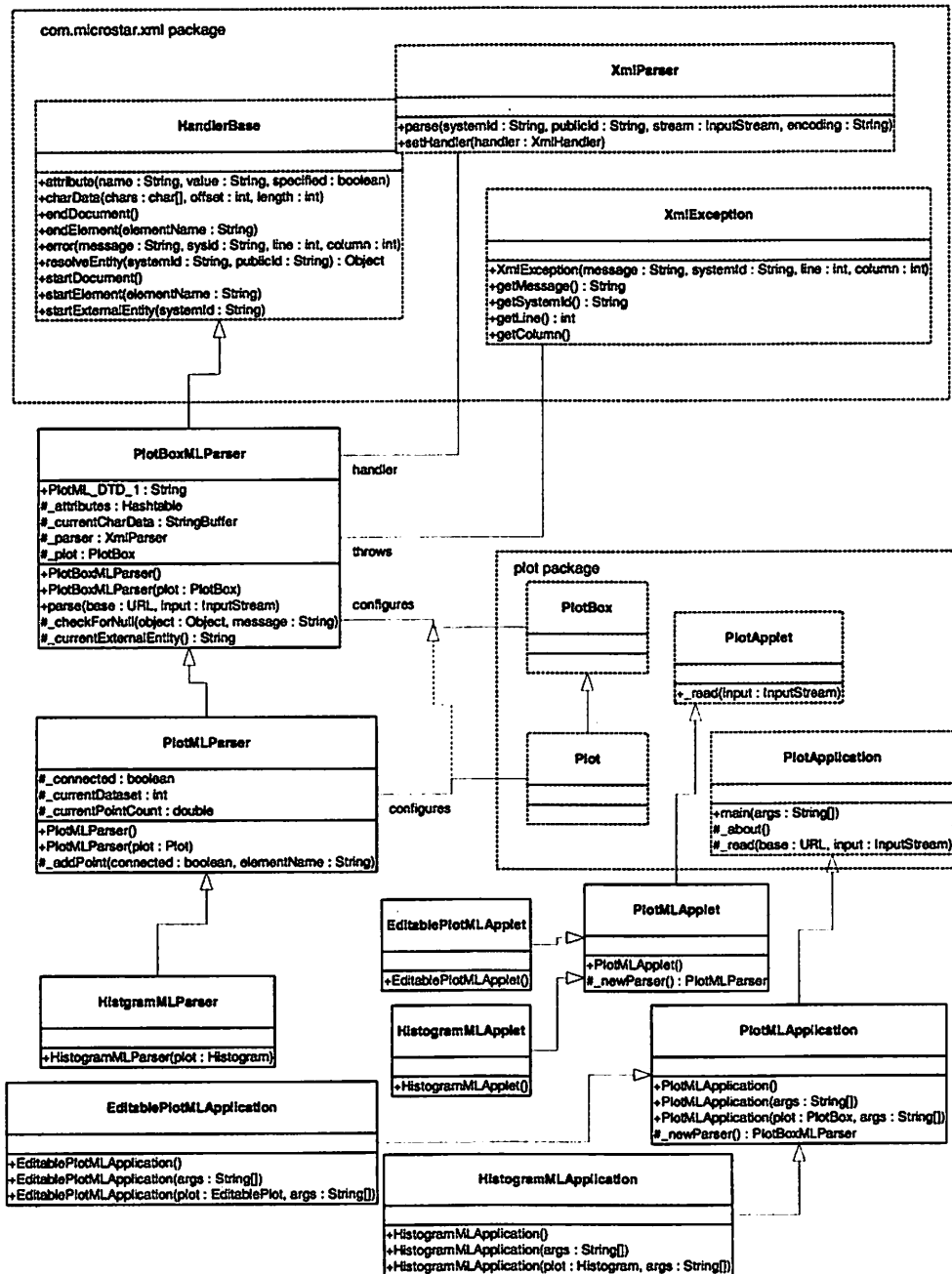

FIGURE 12.8. UML static structure diagram for the plotml package, a subpackage of plot providing classes that read PlotML, an XML extension for specifying plots.

12.3.3 Writing applets

A plot can be easily embedded within an applet, although there are some subtleties. The simplest mechanism looks like this:

```
public class MyApplet extends JApplet {
    public void init() {
        super.init();
        Plot myplot = new Plot();
        getContentPane().add(myplot);
        myplot.setTitle("Title of plot");
        ...
    }
}
```

This places the plot in the center of the applet space, stretching it to fill the space available. To control the size independently of that of the applet, for some mysterious reason that only Sun can answer, it is necessary to embed the plot in a panel, as follows:

```
public class MyApplet extends JApplet {
    public void init() {
        super.init();
        Plot myplot = new Plot();
        JPanel panel = new JPanel();
        getContentPane().add(panel);
        panel.add(myplot);
        myplot.setSize(500, 300);
        myplot.setTitle("Title of plot");
        ...
    }
}
```

The `setSize()` method specifies the width and height in pixels. You will probably want to control the background color and/or the border, using statements like:

```
myplot.setBackground(background color);
myplot.setBorder(new BevelBorder(BevelBorder.RAISED));
```

Alternatively, you may want to make the plot transparent, which results in the background showing through:

```
myplot.setOpaque(false);
```

12.4 PlotML File Format

Plots can be specified as textual data in a language called PlotML, which is an XML extension. XML, the popular *extensible markup language*, provides a standard syntax and a standard way of

defining the content within that syntax. The syntax is a subset of SGML, and is similar to HTML. It is intended for use on the internet. Plot classes can save data in this format (in fact, the Save operation always saves data in this format), and the classes in the plotml subpackage, shown in figure 12.8, can read data in this format. The key classes supporting this syntax are PlotBoxMLParser, which parses a subset of PlotML supported by the PlotBox class, PlotMLParser, which parses the subset of PlotML supported by the Plot class, and HistogramMLParser, which parses the subset that supports histograms.

12.4.1 Data organization

Plot data in PlotML has two parts, one containing the plot data, including format information (how the plot looks), and the other defining the PlotML language. The latter part is called the *document type definition*, or DTD. This dual specification of content and structure is a key XML innovation.

Every PlotML file must either contain or refer to a DTD. The simplest way to do this is with the following file structure:

```
<?xml version="1.0" standalone="no"?>
<!DOCTYPE model PUBLIC "-//UC Berkeley//DTD PlotML 1//EN"
    "http://ptolemy.eecs.berkeley.edu/xml/dtd/PlotML_1.dtd">
<plot>
    format commands...
    datasets...
</plot>
```

Here, “*format commands*” is a set of XML elements that specify what the plot looks like, and “*datasets*” is a set of XML elements giving the data to plot. The syntax for these elements is described below in subsequent sections. The first line above is a required part of any XML file. It asserts the version of XML that this file is based on (1.0) and states that the file includes external references (in this case, to the DTD). The second and third lines declare the document type (plot) and provide references to the DTD.

The references to the DTD above refer to a “public” DTD. The name of the DTD is

```
-//UC Berkeley//DTD PlotML 1//EN
```

which follows the standard naming convention of public DTDs. The leading dash “-” indicates that this is not a DTD approved by any standards body. The first field, surrounded by double slashes, in the name of the “owner” of the DTD, “UC Berkeley.” The next field is the name of the DTD, “DTD PlotML 1” where the “1” indicates version 1 of the PlotML DTD. The final field, “EN” indicates that the language assumed by the DTD is English.

In addition to the name of the DTD, the DOCTYPE element includes a URL pointing to a copy of the DTD on the web. If a particular PlotML tool does not have access to a local copy of the DTD, then it finds it at this web site. PtPlot recognizes the public DTD, and uses its own local version of the DTD, so it does not need to visit this website in order to open a PlotML file.

An alternative way to specify the DTD is:

```
<?xml version="1.0" standalone="no"?>
<!DOCTYPE plot SYSTEM "DTD location">
```

```

<plot>
  format commands...
  datasets...
</plot>

```

Here, the DTD location is a relative or absolute URL.

A third alternative is to create a standalone PlotML file that includes the DTD. The result is rather verbose, but has the general structure shown below:

```

<?xml version="1.0" standalone="yes"?>
<!DOCTYPE plot [
  DTD information
]>
<plot>
  format commands
  datasets
</plot>

```

These latter two methods are useful if you extend the DTD.

The DTD for PlotML is shown in figure 12.9. This defines the PlotML language. However, the DTD is not particularly easy to read, so we define the language below in a more tutorial fashion.

12.4.2 Configuring the axes

The elements described in this subsection are understood by the base class PlotBoxMLParser.

```

<title>Your Text Here</title>

```

The title is bracketed by the start element `<title>` and end element `</title>`. In XML, end elements are always the same as the start element, except for the slash. The DTD for this is simple:

```

<!ELEMENT title (#PCDATA)>

```

This declares that the body consists of *PCDATA*, *parsed character data*.

Labels for the X and Y axes are similar,

```

<xLabel>Your Text Here</xLabel>
<yLabel>Your Text Here</yLabel>

```

Unlike HTML, in XML, case is important. So the element is `xLabel` not `XLabel`.

The ranges of the X and Y axes can be optionally given by:

```

<xRange min="min" max="max"/>
<yRange min="min" max="max"/>

```

The arguments *min* and *max* are numbers, possibly including a sign and a decimal point. If they are not specified, then the ranges are computed automatically from the data and padded slightly so that

```

<!ELEMENT plot (barGraph | bin | dataset | default | noColor | noGrid | size | title | wrap | xLabel |
xLog | xRange | xTicks | yLabel | yLog | yRange | yTicks)*>
<!ELEMENT barGraph EMPTY>
  <!ATTLIST barGraph width CDATA #IMPLIED
  offset CDATA #IMPLIED>
<!ELEMENT bin EMPTY>
  <!ATTLIST bin width CDATA #IMPLIED
  offset CDATA #IMPLIED>
<!ELEMENT dataset (m | move | p | point)*>
  <!ATTLIST dataset connected (yes | no) #IMPLIED
  marks (none | dots | points | various | pixels) #IMPLIED
  name CDATA #IMPLIED
  stems (yes | no) #IMPLIED>
<!ELEMENT default EMPTY>
  <!ATTLIST default connected (yes | no) "yes"
  marks (none | dots | points | various | pixels) "none"
  stems (yes | no) "no">
<!ELEMENT noColor EMPTY>
<!ELEMENT noGrid EMPTY>
<!ELEMENT reuseDatasets EMPTY>
<!ELEMENT size EMPTY>
  <!ATTLIST size height CDATA #REQUIRED
  width CDATA #REQUIRED>
<!ELEMENT title (#PCDATA)>
<!ELEMENT wrap EMPTY>
<!ELEMENT xLabel (#PCDATA)>
<!ELEMENT xLog EMPTY>
<!ELEMENT xRange EMPTY>
  <!ATTLIST xRange min CDATA #REQUIRED
  max CDATA #REQUIRED>
<!ELEMENT xTicks (tick)+>
<!ELEMENT yLabel (#PCDATA)>
<!ELEMENT yLog EMPTY>
<!ELEMENT yRange EMPTY>
  <!ATTLIST yRange min CDATA #REQUIRED
  max CDATA #REQUIRED>
<!ELEMENT yTicks (tick)+>
  <!ELEMENT tick EMPTY>
  <!ATTLIST tick label CDATA #REQUIRED
  position CDATA #REQUIRED>
<!ELEMENT m EMPTY>
  <!ATTLIST m x CDATA #IMPLIED
  y CDATA #REQUIRED
  lowErrorBar CDATA #IMPLIED
  highErrorBar CDATA #IMPLIED>
<!ELEMENT move EMPTY>
  <!ATTLIST move x CDATA #IMPLIED
  y CDATA #REQUIRED
  lowErrorBar CDATA #IMPLIED
  highErrorBar CDATA #IMPLIED>
<!ELEMENT p EMPTY>
  <!ATTLIST p x CDATA #IMPLIED
  y CDATA #REQUIRED
  lowErrorBar CDATA #IMPLIED
  highErrorBar CDATA #IMPLIED>
<!ELEMENT point EMPTY>
  <!ATTLIST point x CDATA #IMPLIED
  y CDATA #REQUIRED
  lowErrorBar CDATA #IMPLIED
  highErrorBar CDATA #IMPLIED>

```

FIGURE 12.9. The document type definition (DTD) for the PlotML language.

datapoints are not plotted on the axes. The DTD for these looks like:

```
<!ELEMENT xRange EMPTY>
  <!ATTLIST xRange min CDATA #REQUIRED
                max CDATA #REQUIRED>
```

The `EMPTY` means that the element does not have a separate start and end part, but rather has a final slash before the closing character `</>`. The two `ATTLIST` elements declare that `min` and `max` attributes are required, and that they consist of character data.

The tick marks for the axes are usually computed automatically from the ranges. Every attempt is made to choose reasonable positions for the tick marks regardless of the data ranges (powers of ten multiplied by 1, 2, or 5 are used). However, they can also be specified explicitly using elements like:

```
<xTicks>
  <tick label="label" position="position"/>
  <tick label="label" position="position"/>
  ...
</xTicks>
```

A *label* is a string that replaces the number labels on the axes. A *position* is a number giving the location of the tick mark along the axis. For example, a horizontal axis for a frequency domain plot might have tick marks as follows:

```
<xTicks>
  <tick label="-PI" position="-3.14159"/>
  <tick label="-PI/2" position="-1.570795"/>
  <tick label="0" position="0"/>
  <tick label="PI/2" position="1.570795"/>
  <tick label="PI" position="3.14159"/>
</xTicks>
```

Tick marks could also denote years, months, days of the week, etc. The relevant DTD information is:

```
<!ELEMENT xTicks (tick)+>
  <!ELEMENT tick EMPTY>
  <!ATTLIST tick label CDATA #REQUIRED
                position CDATA #REQUIRED>
```

The notation `(tick)+` indicates that the `xTicks` element contains one or more `tick` elements.

If ticks are not specified, then the X and Y axes can use a logarithmic scale with the following elements:

```
<xLog/>
<yLog/>
```

The tick labels, which are computed automatically, represent powers of 10. The log axis facility has a number of limitations, which are documented in "Limitations" on page 12-23.

By default, tick marks are connected by a light grey background grid. This grid can be turned off with the following element:

```
<noGrid/>
```

Also, by default, the first ten data sets are shown each in a unique color. The use of color can be turned off with the element:

```
<noColor/>
```

Finally, the rather specialized element

```
<wrap/>
```

enables wrapping of the X (horizontal) axis, which means that if a point is added with X out of range, its X value will be modified modulo the range so that it lies in range. This command only has an effect if the X range has been set explicitly. It is designed specifically to support oscilloscope-like behavior, where the X value of points is increasing, but the display wraps it around to left. A point that lands on the right edge of the X range is repeated on the left edge to give a better sense of continuity. The feature works best when points do land precisely on the edge, and are plotted from left to right, increasing in X.

You can also specify the size of the plot, in pixels, as in the following example:

```
<size width="400" height="300">
```

All of the above commands can also be invoked directly by calling the corresponding public methods from Java code.

12.4.3 Configuring data

Each data set has the form of the following example

```
<dataset name="grades" marks="dots" connected="no" stems="no">  
  data  
</dataset>
```

All of the arguments to the `dataset` element are optional. The name, if given, will appear in a legend at the upper right of the plot. The `marks` option can take one of the following values:

- `none`: (the default) No mark is drawn for each data point.
- `points`: A small point identifies each data point.
- `dots`: A larger circle identifies each data point.
- `various`: Each dataset is drawn with a unique identifying mark. There are 10 such marks, so they will be recycled after the first 10 data sets.
- `pixels`: A single pixel identified each data point.

The `connected` argument can take on the values "yes" and "no." It determines whether successive datapoints are connected by a line. The default is that they are. Finally, the `stems` argument, which

can also take on the values “yes” and “no,” specifies whether stems should be drawn. Stems are lines drawn from a plotted point down to the x axis. Plots with stems are often called “stem plots.”

The DTD is:

```
<!ELEMENT dataset (m | move | p | point)*>
  <!ATTLIST dataset connected (yes | no) #IMPLIED
    marks (none | dots | points | various | pixels) #IMPLIED
    name CDATA #IMPLIED
    stems (yes | no) #IMPLIED>
```

The default values of these arguments can be changed by preceding the dataset elements with a default element, as in the following example:

```
<default connected="no" marks="dots" stems="yes"/>
```

The DTD for this element is:

```
<!ELEMENT default EMPTY>
  <!ATTLIST default connected (yes | no) "yes"
    marks (none | dots | points | various | pixels) "none"
    stems (yes | no) "no">
```

If the following element occurs:

```
<reuseDatasets/>
```

then datasets with the same name will be merged. This makes it easier to combine multiple data files that contain the same datasets into one file. By default, this capability is turned off, so datasets with the same name are not merged.

12.4.4 Specifying data

A dataset has the form

```
<dataset options>
  data
</dataset>
```

The data itself are given by a sequence of elements with one of the following forms:

```
<point y="yValue">
<point x="xValue" y="yValue">
<point y="yValue" lowErrorBar="low" highErrorBar="high">
<point x="xValue" y="yValue" lowErrorBar="low" highErrorBar="high">
```

To reduce file size somewhat, they can also be given as

```
<p y="yValue">
<p x="xValue" y="yValue">
<p y="yValue" lowErrorBar="low" highErrorBar="high">
<p x="xValue" y="yValue" lowErrorBar="low" highErrorBar="high">
```

The first form specifies only a Y value. The X value is implied (it is the count of points seen before in this data set). The second form gives both the X and Y values. The third and fourth forms give low and high error bar positions (error bars are used to indicate a range of values with one data point). Points given using the syntax above will be connected by lines if the `connected` option has been given value "yes" (or if nothing has been said about it).

Data points may also be specified using one of the following forms:

```
<move y="yValue">
<move x="xValue" y="yValue">
<move y="yValue" lowErrorBar="low" highErrorBar="high">
<move x="xValue" y="yValue" lowErrorBar="low" highErrorBar="high">

<m y="yValue">
<m x="xValue" y="yValue">
<m y="yValue" lowErrorBar="low" highErrorBar="high">
<m x="xValue" y="yValue" lowErrorBar="low" highErrorBar="high">
```

This causes a break in connected points, if lines are being drawn between points. I.e., it overrides the `connected` option for the particular data point being specified, and prevents that point from being connected to the previous point.

12.4.5 Bar graphs

To create a bar graph, use:

```
<barGraph width="barWidth" offset="barOffset"/>
```

You will also probably want the `connected` option to have value "no." The `barWidth` is a real number specifying the width of the bars in the units of the X axis. The `barOffset` is a real number specifying how much the bar of the *i*-th data set is offset from the previous one. This allows bars to "peek out" from behind the ones in front. Note that the front-most data set will be the first one.

12.4.6 Histograms

To configure a histogram on a set of data, use

```
<bin width="binWidth" offset="binOffset"/>
```

The `binWidth` option gives the width of a histogram bin. I.e., all data values within one `binWidth` are counted together. The `binOffset` value is exactly like the `barOffset` option in bar graphs. It specifies by how much successive histograms "peek out."

Histograms work only on Y data; X data is ignored.

12.5 Old Textual File Format

Instances of the `PlotBox` and `Plot` classes can read a simple file format that specifies the data to be plotted. This file format predates the PlotML format, and is preserved primarily for backward compatibility. In addition, it is significantly more concise than the PlotML syntax, which can be advantageous, particularly in networked applications.

In this older syntax, each file contains a set of commands, one per line, that essentially duplicate the methods of these classes. There are two sets of commands currently, those understood by the base class `PlotBox`, and those understood by the derived class `Plot`. Both classes ignore commands that they do not understand. In addition, both classes ignore lines that begin with “#”, the comment character. The commands are not case sensitive.

12.5.1 Commands Configuring the Axes

The following commands are understood by the base class `PlotBox`. These commands can be placed in a file and then read via the `read()` method of `PlotBox`, or via a URL using the `PlotApplet` class. The recognized commands include:

- `TitleText: string`
- `XLabel: string`
- `YLabel: string`

These commands provide a title and labels for the X (horizontal) and Y (vertical) axes. A *string* is simply a sequence of characters, possibly including spaces. There is no need here to surround them with quotation marks, and in fact, if you do, the quotation marks will be included in the labels.

The ranges of the X and Y axes can be optionally given by commands like:

- `XRange: min, max`
- `YRange: min, max`

The arguments *min* and *max* are numbers, possibly including a sign and a decimal point. If they are not specified, then the ranges are computed automatically from the data and padded slightly so that datapoints are not plotted on the axes.

The tick marks for the axes are usually computed automatically from the ranges. Every attempt is made to choose reasonable positions for the tick marks regardless of the data ranges (powers of ten multiplied by 1, 2, or 5 are used). However, they can also be specified explicitly using commands like:

- `XTicks: label position, label position, ...`
- `YTicks: label position, label position, ...`

A *label* is a string that must be surrounded by quotation marks if it contains any spaces. A *position* is a number giving the location of the tick mark along the axis. For example, a horizontal axis for a frequency domain plot might have tick marks as follows:

```
XTicks: -PI -3.14159, -PI/2 -1.570795, 0 0, PI/2 1.570795, PI 3.14159
```

Tick marks could also denote years, months, days of the week, etc.

The X and Y axes can use a logarithmic scale with the following commands:

- `XLog: on`
- `YLog: on`

The tick labels, if computed automatically, represent powers of 10. The log axis facility has a number

of limitations, which are documented in “Limitations” on page 12-23.

By default, tick marks are connected by a light grey background grid. This grid can be turned off with the following command:

- `Grid: off`

It can be turned back on with

- `Grid: on`

Also, by default, the first ten data sets are shown each in a unique color. The use of color can be turned off with the command:

- `Color: off`

It can be turned back on with

- `Color: on`

Finally, the rather specialized command

- `Wrap: on`

enables wrapping of the X (horizontal) axis, which means that if a point is added with X out of range, its X value will be modified modulo the range so that it lies in range. This command only has an effect if the X range has been set explicitly. It is designed specifically to support oscilloscope-like behavior, where the X value of points is increasing, but the display wraps it around to left. A point that lands on the right edge of the X range is repeated on the left edge to give a better sense of continuity. The feature works best when points do land precisely on the edge, and are plotted from left to right, increasing in X.

All of the above commands can also be invoked directly by calling the corresponding public methods from some Java code.

12.5.2 Commands for Plotting Data

The set of commands understood by the Plot class support specification of data to be plotted and control over how the data is shown.

The style of marks used to denote a data point is defined by one of the following commands:

- `Marks: none`
- `Marks: points`
- `Marks: dots`
- `Marks: various`
- `Marks: pixels`

Here, `points` are small dots, while `dots` are larger. If `various` is specified, then unique marks are used for the first ten data sets, and then recycled. If `pixels` is specified, then a single pixel is drawn. Using no marks is useful when lines connect the points in a plot, which is done by default. If the above directive appears before any `DataSet` directive, then it specifies the default for all data sets. If it appears after a `DataSet` directive, then it applies only to that data set.

To disable connecting lines, use:

- `Lines: off`

To re-enable them, use

- `Lines: on`

You can also specify “impulses”, which are lines drawn from a plotted point down to the x axis.

Plots with impulses are often called “stem plots.” These are off by default, but can be turned on with the command:

- `Impulses: on`

or back off with the command

- `Impulses: off`

If that command appears before any `DataSet` directive, then the command applies to all data sets. Otherwise, it applies only to the current data set.

To create a bar graph, turn off lines and use any of the following commands:

- `Bars: on`
- `Bars: width`
- `Bars: width, offset`

The *width* is a real number specifying the width of the bars in the units of the x axis. The *offset* is a real number specifying how much the bar of the *i*-th data set is offset from the previous one. This allows bars to “peek out” from behind the ones in front. Note that the front-most data set will be the first one. To turn off bars, use

- `Bars: off`

To specify data to be plotted, start a data set with the following command:

- `DataSet: string`

Here, *string* is a label that will appear in the legend. It is not necessary to enclose the string in quotation marks.

To start a new dataset without giving it a name, use:

- `DataSet:`

In this case, no item will appear in the legend.

If the following directive occurs:

- `ReuseDataSets: on`

then datasets with the same name will be merged. This makes it easier to combine multiple data files that contain the same datasets into one file. By default, this capability is turned off, so datasets with the same name are not merged.

The data itself is given by a sequence of commands with one of the following forms:

- `x, y`
- `draw: x, y`
- `move: x, y`
- `x, y, yLowErrorBar, yHighErrorBar`
- `draw: x, y, yLowErrorBar, yHighErrorBar`
- `move: x, y, yLowErrorBar, yHighErrorBar`

The `draw` command is optional, so the first two forms are equivalent. The `move` command causes a break in connected points, if lines are being drawn between points. The numbers *x* and *y* are arbitrary numbers as supported by the `Double` parser in Java (e.g. “1.2”, “6.39e-15”, etc.). If there are four numbers, then the last two numbers are assumed to be the lower and upper values for error bars. The numbers can be separated by commas, spaces or tabs.

12.6 Compatibility

Figure 12.10 shows a small set of classes in the compat package that support an older ascii and binary file formats used by the popular `pxgraph` program (an extension of `xgraph` to support binary formats). The `PxgraphApplication` class can be invoked by the `pxgraph` executable in `$PTII/bin`. See the `PxgraphParser` class documentation for information about the file format.

12.7 Limitations

The plot package is a starting point, with a number of significant limitations.

- A binary file format that includes plot format information is needed. This should be an extension of PlotML, where an external entity is referenced.
- If you zoom in far enough, the plot becomes unreliable. In particular, if the total extent of the plot is more than 2^{32} times extent of the visible area, quantization errors can result in displaying points or lines. Note that 2^{32} is over 4 billion.
- The log axis facility has a number of limitations. Note that if a logarithmic scale is used, then the values must be positive. **Non-positive values will be silently dropped.** Further log axis limitations are listed in the documentation of the `_gridInit()` method in the `PlotBox` class.
- Graphs cannot be currently copied via the clipboard.
- There is no mechanism for customizing the colors used in a plot.

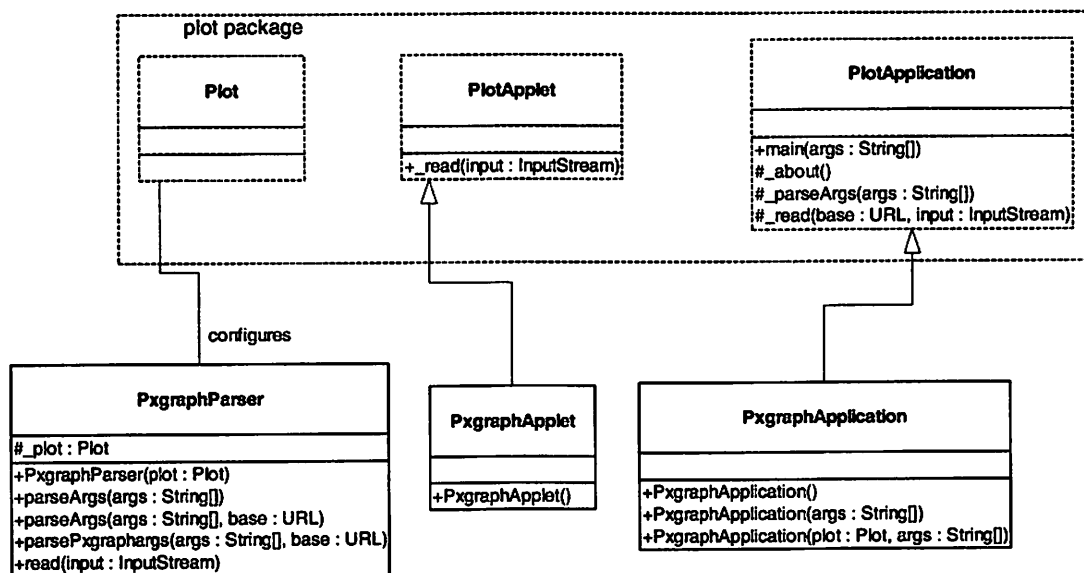
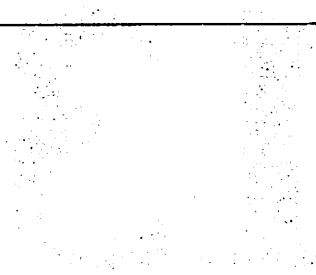

FIGURE 12.10. The compat package provides compatibility with the older `pxgraph` program.



Plot 1: [Illegible text]

Plot 2: [Illegible text]

[Illegible text]

[Illegible text]

[Illegible text]

[Illegible text]

[Illegible text]

[Illegible text]

[Illegible text]

[Illegible text]

[Illegible text]

13

Vergil

*Authors: Steve Neuendorffer
Edward A. Lee*

13.1 Introduction

When the first computers were built, it was possible to program them, but only through an arduous manual process. One of the first pieces of software that was written was a bootloader that simplified the process of reprogramming those computers. For example, the bootloader may load a program into memory from a floppy drive. The bootloader was the first, simplest form of operating system. It provided infrastructure for abstracting the process of initializing the code of computers. The simplest operating system merely provides a mechanism for invoking other programs.

Later operating system layered services on top of the bootloader that provided more facilities to ease programming and abstract hardware. Services like file systems, device drivers, and process scheduling provide mechanisms through which user applications use hardware resources. These services provide a simple abstraction layer through which many pieces of computer hardware can be accessed. These operating systems traditionally provided some sort of command shell, such as DOS or bash. In some cases, the invocation mechanism takes the form of a graphical user interface, where icons represent files and applications.

Some operating systems also provide more complex application support, such as user preferences, application component management, and file to application binding. These services attempt to make it easier to develop applications, however they are not strictly necessary for developing applications. For example, it is fully possible to write a Windows application without using the registry, or COM objects. However, because these services are integrated into the Operating System at a very low level, using them can be rather tricky. Overwriting the wrong registry entry may prevent the operating system from working properly. Updating a COM object can prevent other applications from working

properly. Netscape and Internet Explorer constantly fight over the right to open HTML files. The difficulty arises because these services are built into the operating system and also impose requirements on how applications are managed. These types of services are important when building useable applications, but they are not appropriate for inclusion in a low-level operating system.

Vergil is a set of infrastructure tools that provides these application support services as another operating system layer. This layer is built on top of the hardware abstraction layer while making minimal use of the operating system's application support infrastructure. Java is the perfect platform on which to build these services, since it provides good hardware abstraction on a wide variety of platforms, but few services for building applications. We have used the infrastructure to build a design application for Ptolemy II, but the infrastructure itself is general. Below we will describe the infrastructural goals, the architecture, and how we have applied the infrastructure to the Ptolemy design application. For information about using the Vergil Application to build a Ptolemy II model, see the Using Vergil chapter.

13.2 Infrastructure

The goals of building design application infrastructure are somewhat different from the goals of building a design application. Where an application is often described by the features that it implements or the manipulation that it allows, infrastructure must provide solutions to common problems within a certain area. Below we describe the various pieces of Vergil, and how each one makes it easier to develop consistent, usable design applications.

13.2.1 Design Artifacts

The goal of a design application is the creation of a particular type of design artifact. A design artifact is any electronic entity that is created to serve a specific purpose such as a text file, a circuit design, or a piece of computer software. Design artifacts almost always have a variety of aspects, and it is usually difficult to display all of these aspects at once. Good examples of this are Microsoft PowerPoint presentations. A presentation contains many slides, and each slide can be individually displayed and manipulated. Each slide can contain many different kinds of objects (which are often themselves distinct embedded design artifacts). The presentation itself can also contain timing, narration and navigation information. The PowerPoint application can change the information displayed to emphasize a particular aspect of the presentation, such as a particular slide or a slide overview or a text-only view.

13.2.2 Storage policies

The most basic operation that almost any application must perform is the storage and retrieval of designs. Most applications store design artifacts as files visible through the operating system, however we would like to be somewhat more general and allow design artifacts to be stored in databases or accessed through the World Wide Web. We believe that URLs are general enough to describe any such location. The infrastructure that we would like build for handling files revolves around a *storage policy*. The storage policy gives a basic set of consistent rules for how design objects are persistently stored. In plain English, these rules can be simple, or fairly complex. One example of a simple storage policy rule might be that to open a design artifact, the location is specified using a file browser dialog. A more complex rule could state that a design artifact cannot be closed unexpectedly without giving the user an opportunity to save. Implementing a storage policy in basic infrastructure is good for sev-

eral reasons. First of all, it prevents application writers from being concerned with relatively boring parts of an application. Secondly, it is very important for application usability that the storage policy be consistent.

13.2.3 Views

A particular design artifact may have different ways that it can be viewed and manipulated. For example, an HTML document may be viewed as rendered HTML, or as plain text with HTML markup. The infrastructure that we have built assumes that each different view of a design artifact is associated with a top level frame. The creation of a view is in some respects independent from loading a file. However, when a design artifact is first opened, a default view must be created for it. Furthermore, when the last view of the artifact is destroyed, the artifact should be closed. In this way, the view (or views) of a design artifact are exactly analogous to the file in which the design artifact is stored. When all of the frames are gone, the file is conceptually 'closed' and not accessible.

This correspondence has some important ramifications in the design of our infrastructure. Since, from the point of view of the user the frames are the file, they must all display consistent data. Furthermore, opening a design artifact a second time should only create a new frame if the artifact is not already open. If the design artifact is already open, then its views should simply be made visible.

13.3 Architecture

The key to the Vergil infrastructure is a set of classes that represent the different parts of common design applications. The common application operations are then expressed in terms of these classes. This makes it easy to create new application tools that are integrated with others built with the infrastructure by simply extending a few classes.

13.3.1 Effigies and Tableaux

Each design artifact is represented by an instance of the Effigy class. Each effigy is associated with a URL, corresponding to the location of the persistent storage of the effigy. Each effigy also has an identifier, which is the unique string that identifies the effigy. This identifier should be a string representation of the effigy's URL. Each view of the design artifact is represented by an instance of the Tableau class contained by the design artifact's effigy. Each tableau is associated with a single frame that presents information from the effigy. In some cases, in order to reuse code for tableaux, it is sometimes useful to have an effigy contain other effigies. The static structure diagram for this is shown in figure 13.1.

13.3.2 Effigy Factories

Notice that the Effigy base class does not specify how it represents a particular design artifact. This is intentional, since we are building infrastructure and do not wish to restrict ourselves to any particular representation. However, at some point the infrastructure will need to create new effigies that are useful for a particular application. In this situation, the Factory design pattern is appropriate, which is shown in figure 13.2. An example of how the Effigy and EffigyFactory base classes are used is shown in figure 13.3. The example shows an effigy and factory appropriate for handling text documents.

The EffigyFactory class contains two factory methods for creating new effigies. The first factory

method takes a source URL and is used when opening a file. The second method does not take a source URL and is used when creating a new blank effigy. These two methods roughly correspond to the familiar File->Open and File->New operations.

The EffigyFactory base class is also useful for implementing a deference mechanism. The base class can contain other effigy factories and will defer to the first contained factory that successfully creates a effigy for a given file. This deference mechanism allows the factories to be ordered so that a more specific effigy (such as one that represents HTML structure) can be checked before a more gen-

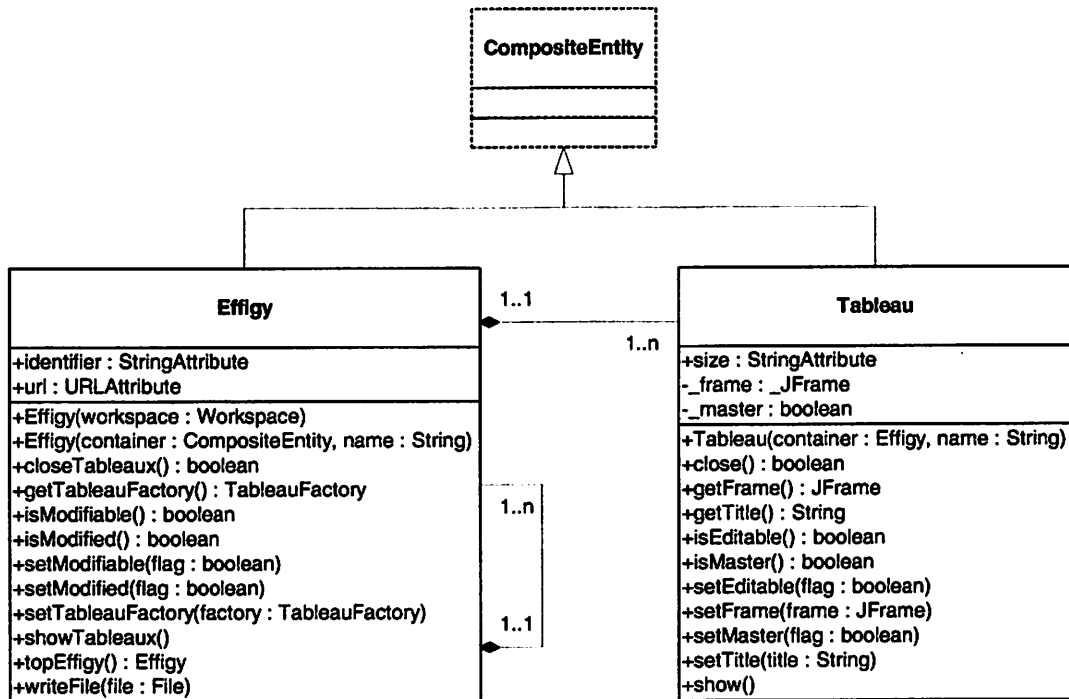

Figure 13.1 Static structure diagram for effigies and tableaux.

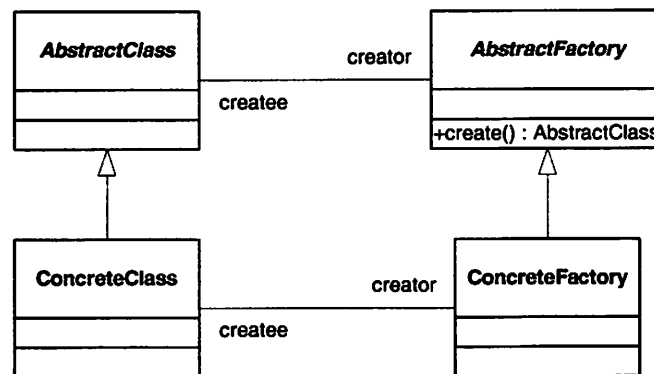

Figure 13.2 Static structure diagram for the Factory pattern.

eral one (such as an effigy that simply contains a text string).

13.3.3 Tableau Factories

Once an effigy has been created, a frame on the screen doesn't actually exist to represent it yet. The frame is created by a tableau, and the tableau is created by another factory. The TableauFactory class implements the same deference mechanism as the EffigyFactory class. The static structure for the tableau factory class, along with the related classes from the text example above is shown in figure 13.4.

13.3.4 Model Directory

All effigies in the application are contained (directly, or indirectly in another effigy) in an instance of the ModelDirectory class. The model directory allows entities to be found by identifier. Whenever a design artifact is loaded from a URL, the model directory is searched first to prevent the artifact from being loaded again.

13.3.5 Configurations

An instance of the Configuration class represents the configuration of an application. That configuration includes not only the directory of currently open effigies but also the effigy factories and tableau factories. The static structure for the Configuration and ModelDirectory classes is show in figure 13.5.

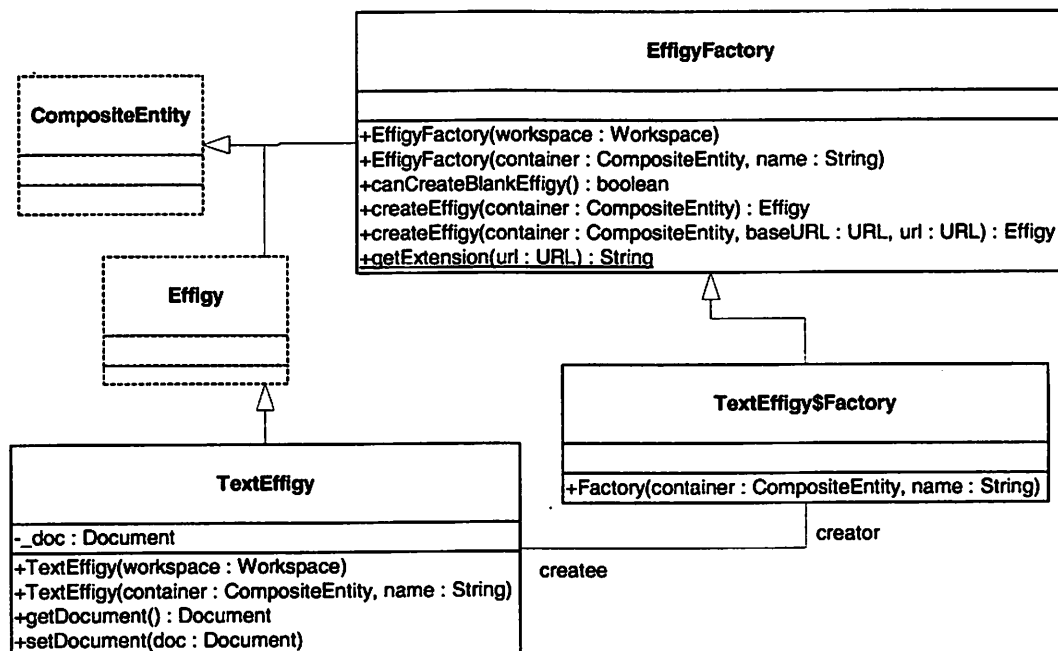

Figure 13.3 Static structure that is useful for handling text documents.

13.3.6 TableauFrame

The TableauFrame class uses the above classes to implement a number of common operations. The intention of this class is that the type-specific subclasses of the Tableau class would create instances of TableauFrame specialized for displaying particular information. Generally, the Top base class implements the menus for these operations and provides some abstract methods that are used for reading and writing files. The TableauFrame class implements these abstract methods. For the rest of

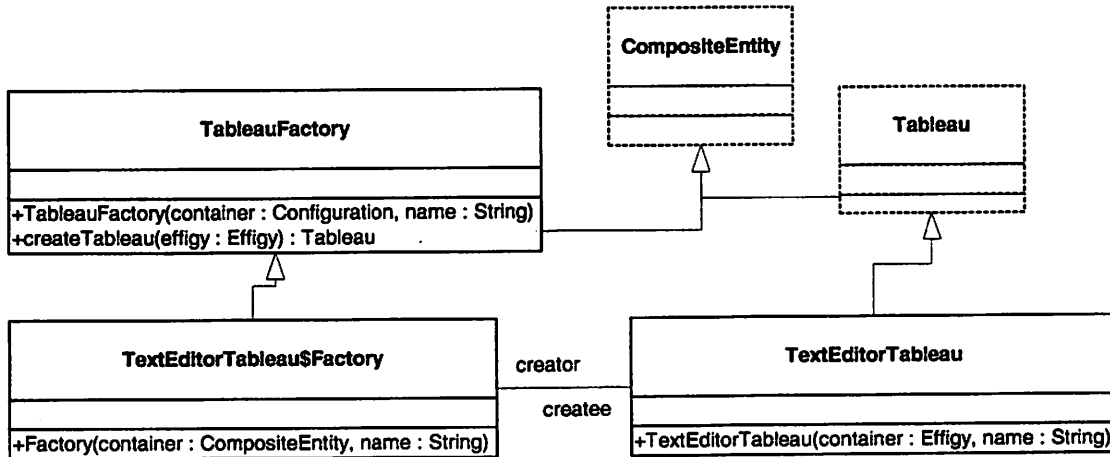

Figure 13.4 Static structure of how the TableauFactory class, and an example of how tableau factories are used with text documents.

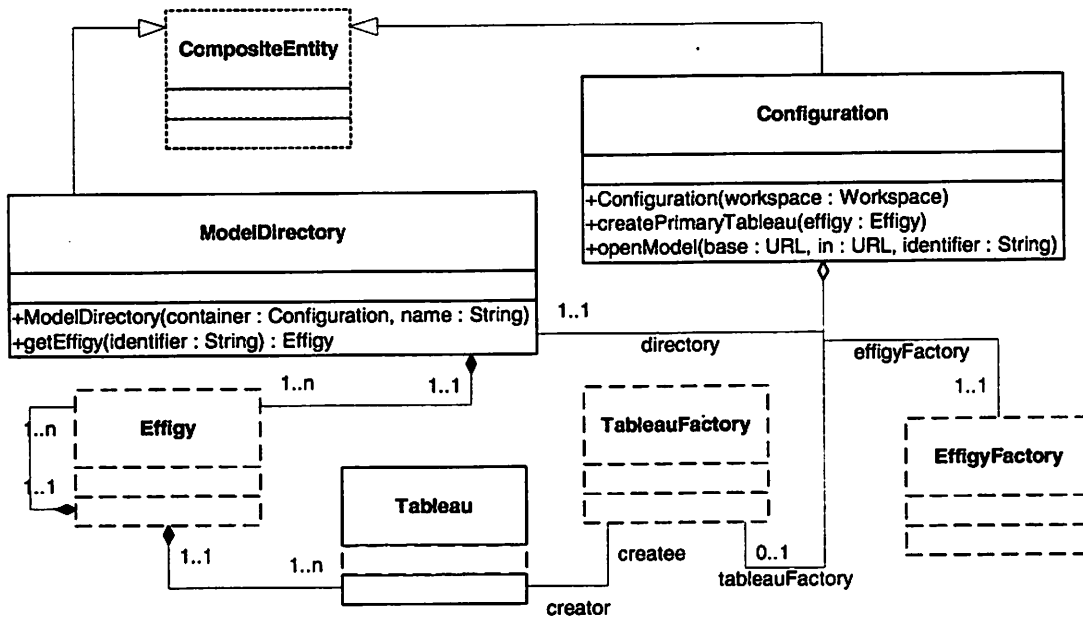

Figure 13.5 Static structure diagram for the Configuration and ModelDirectory classes.

this document, the line between the Top and TableauFrame classes is not terribly important, and will be purposefully blurred for sake of clarity. The static structure for the TableauFrame class (and its super classes) is show in figure 13.6.

13.4 Common operations

The goal of the infrastructure classes above is to implement common operations, such as storing and creating new design artifacts, in a consistent fashion. These operations are (for the most part) actually implemented in the TableauFrame base class. Below are descriptions of each of these operations, and how they are implemented using the architecture from the previous section.

13.4.1 Opening an Existing Design Artifact

The File->Open menu item first opens a file browser to allow the user to select a URL, and then uses the Configuration to open the URL. The configuration firsts checks the model directory to see if there is already an effigy associated that URL. If there is no such effigy, then the configuration uses its effigy factory to create a new effigy, and then uses its tableau factory to create a tableau for the effigy.

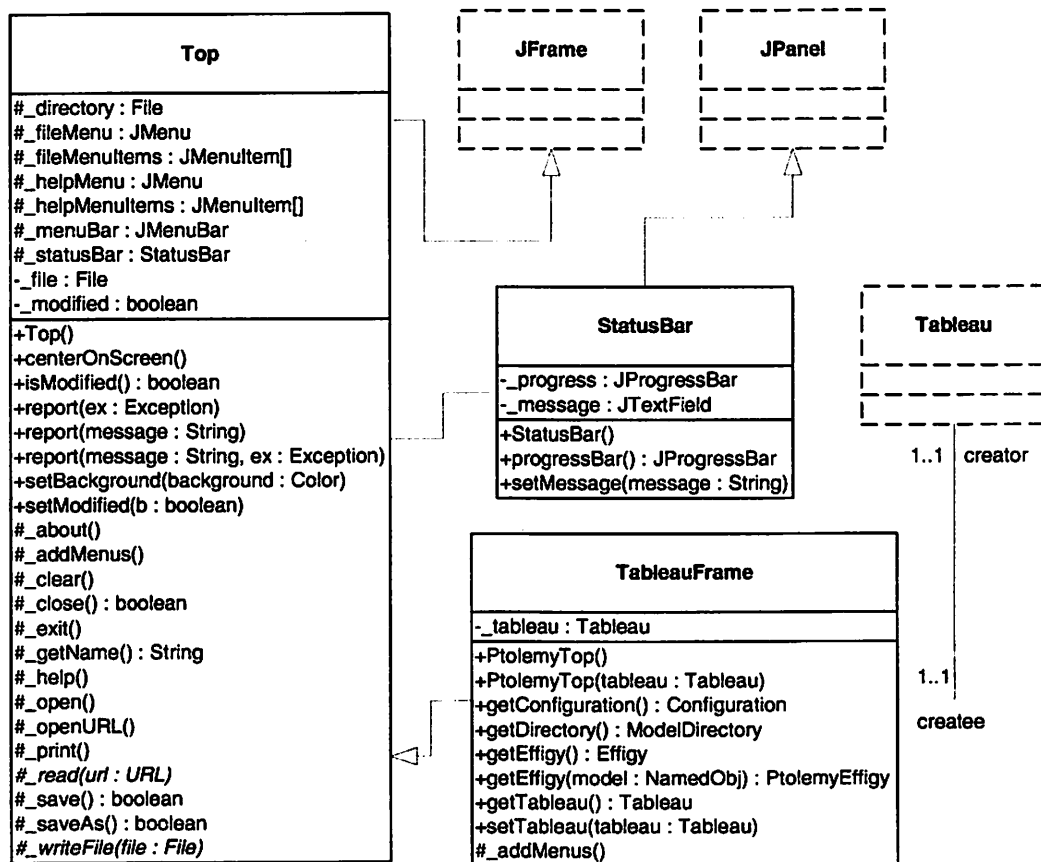

Figure 13.6 Static structure diagram for the TableauFrame class.

Lastly, the tableau is made visible, which results in it creating a frame on the user's screen. The sequence diagram is shown in figure 13.7. In addition, this first tableau is set to be a master, and it is set to be editable if the URL represents a writable location.

Alternatively, there may already an effigy present in the directory that is associated with the URL chosen by the user. In this case, the tableaux (if any) contained by the effigy are simply made visible. Remember that a single application is capable of opening a wide variety of design artifacts by virtues of the effigy factory deference mechanism explained in section 13.3.2.

13.4.2 Creating a New Design Artifact

Creating a new design artifact using the File->New menu item is somewhat similar to opening an existing design artifact. However, only effigy factories that declare that they can create a blank effigy that is not associated with a previous URL may be used. Furthermore, since an application can conceivably create different types of blank effigies, it is not possible to use the effigy factory deference mechanism to determine which effigy factory is used. The user must have another way of specifying which effigy factory will create the blank effigy. When a TableauFrame is created, the File->New

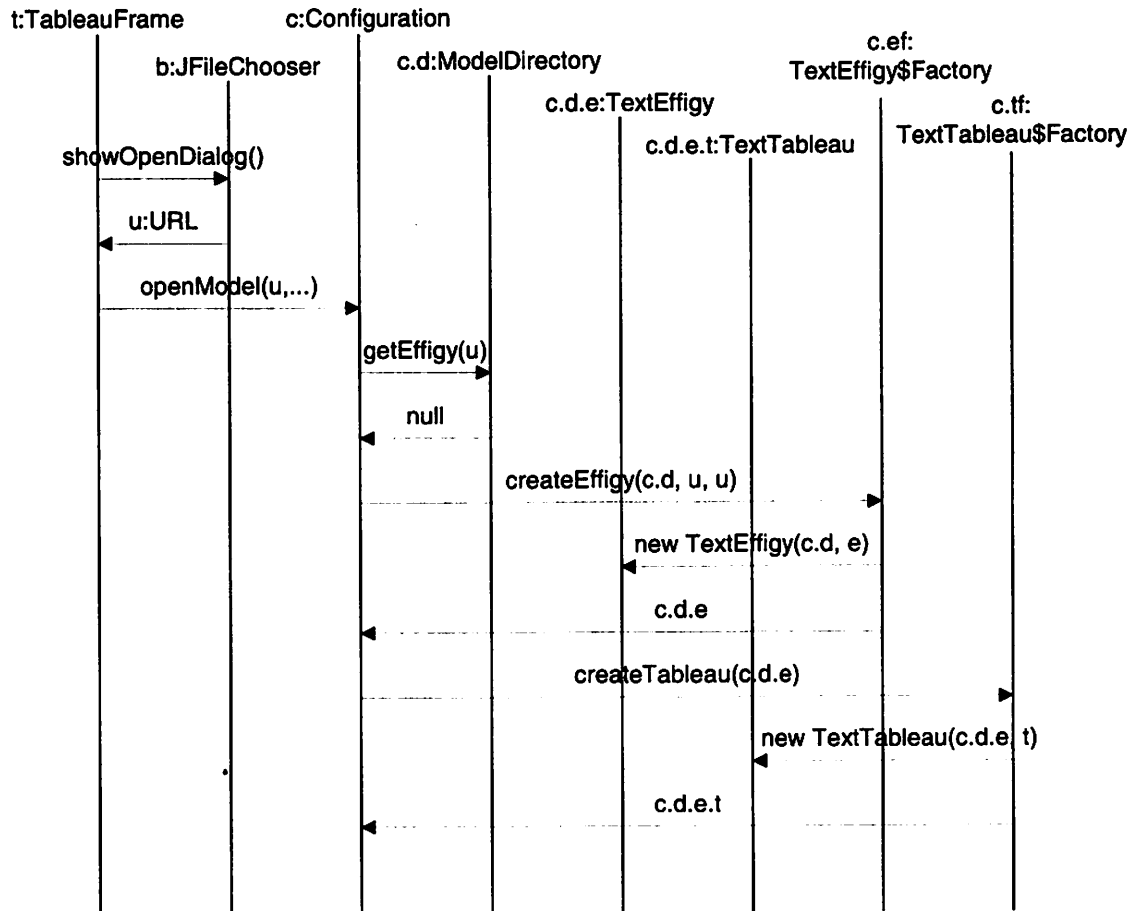

Figure 13.7 Sequence diagram for opening an existing design artifact.

menu is populated with a menu item for each possible effigy factory. The name of the menu item is the same as the name of the effigy factory. The sequence diagram for creating a new design artifact is shown in figure 13.8.

13.4.3 Saving Changes to a Design Artifact

The TableauFrame class implements menu items for both File->Save and File->Save As. The Save operation rather simple. If the effigy is already associated with a URL that is writable, then the effigy is simply written out to that location. Otherwise, the Save As operation is invoked instead. This may occur if the design artifact was created from scratch as a blank effigy, or if the artifact was loaded by HTTP. The Save As operation is a bit more complicated. The user specifies a destination URL using a file chooser, just as when opening a new design. However, before writing the file it is necessary to check that the URL does not already exist and that the URL is not already open. In these cases, the user is prompted to be sure that important data is not inadvertently lost by being overwritten.

13.4.4 Closing designs and Exiting the Application

The only complexities in implementing these operations are again involved with ensuring that important data is not lost. In this case, we simply ensure that all designs are closed before exiting the application, and that a design is not closed without attempting to save it first. Both of these cases are prevented by setting a flag in each effigy whenever it is modified. If the flag indicates that the effigy has been modified, then the Save operation is invoked before discarding the effigy.

Activating the close operation of a frame only results in the tableau associated with that frame being removed. The tableau's effigy and the other tableaux associated with that effigy are not generally

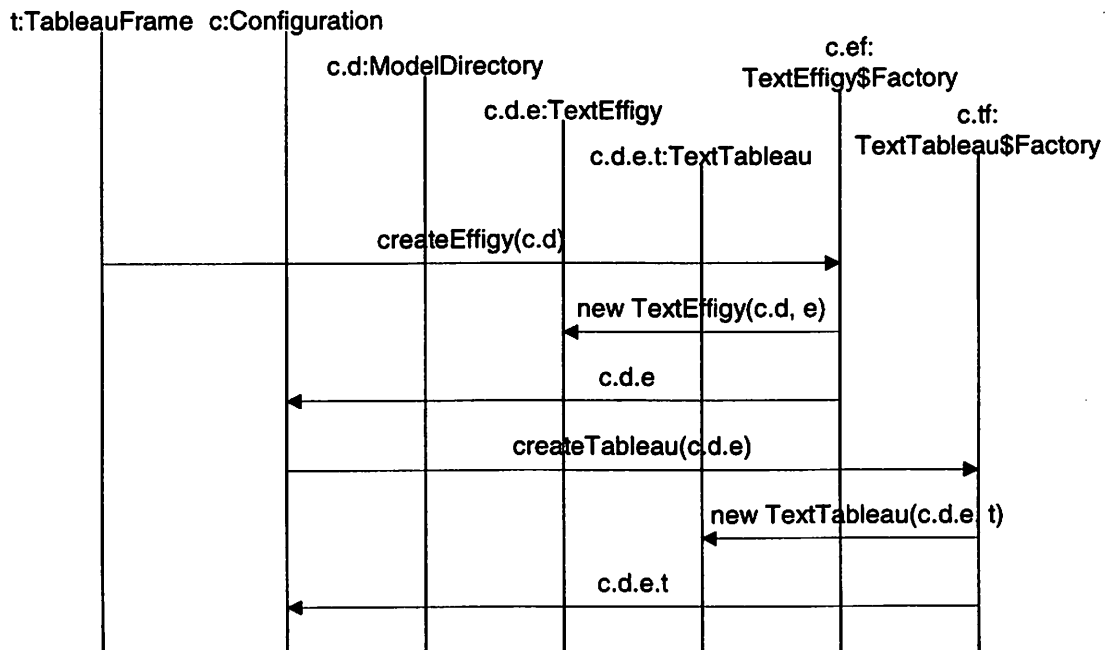

Figure 13.8 Sequence diagram for creating a new design artifact.

affected. There is a subtlety that arises because the application itself exists separately from any visual representation of it. In other words, a tableau (and therefore a frame) exists for each effigy, but there is no tableau that simply represents the application as a whole¹. The subtlety is that closing all the effigies should result in the application exiting. A similar issue occurs for a similar reason with effigies, and closing all of a tableaux associated with any effigy should result in that effigy being closed.

13.5 Ptolemy Model Visualization

We have used the Vergil infrastructure to construct several visualizations that are capable of viewing and manipulating a Ptolemy model. For the most part, these editors are intended to work with any ptolemy kernel model and are not limited to models based on the Actor package or a specific domain. This is an extremely powerful use of the Ptolemy abstract syntax, since it allows manipulation not only of executable models (see Chapter FIXME), but also actor libraries (see Figure FIXME) and the Vergil configuration itself (see Figure 13.5), since they are also based on the Ptolemy Kernel (see Chapter FIXME). This section serves a dual purpose: it describes not only a usable set of application tools, but also a well developed example of using the Vergil infrastructure to present multiple views of a design artifact.

In order to represent a Ptolemy model in Vergil, there must be an effigy that has a reference to it. The PtolemyEffigy class maintains this reference, and is also responsible for reporting any change requests (see Chapter FIXME) in the model that fail. It also contains an inner class that is an effigy factory and writes out a model using MoML (see Chapter FIXME). The static structure diagram for these classes is shown in Figure 13.9 There is also an accompanying frame class, PtolemyFrame, that is intended to be used as shown in Figure 13.10. The tableaux that are capable of creating a frame for a Ptolemy effigy are described in the following sections.

13.5.1 Graph Tableau

The Ptolemy graph editor graphically represents the contained entities, ports, and relations of any Ptolemy composite entity. It allows syntax-directed editing of the model and browsing of important design information, such as Actor source code and HTML documentation. A screen shot is shown in Figure 13.11. The left hand side provides a palette of available entities and a high-level navigation window. Entities can be dragged and dropped from the palette. External ports are created by using the toolbar button, and relations can be created from the toolbar button, or by control clicking on the schematic. Links to relations can be created by control clicking on a port or a relation. The visualization also allows connections directly from one port to another. These links correspond to a relation that is linked to both ports, but the relation is not explicitly represented itself.

Note that although the editor allows any ptolemy model to be edited, it does display some information that is specific to the actor package. For example, ports are rendered differently depending on whether they are input or output ports, and the multiports of the Multiply actor are rendered hollow. The director (in this case, an SDF director) is also displayed as a green box.

The classes used to implement this tableau are shown in Figure 13.12. An instance of KernelGraphFrame is created by the tableau. The KernelGraphFrame class overrides the `_createGraphPane` factory method to create the graph editor itself, while most of the user interface components (like

1. Although it is probably good design practice to create an initial effigy and tableau that represent the application and allows the user to open an initial file.

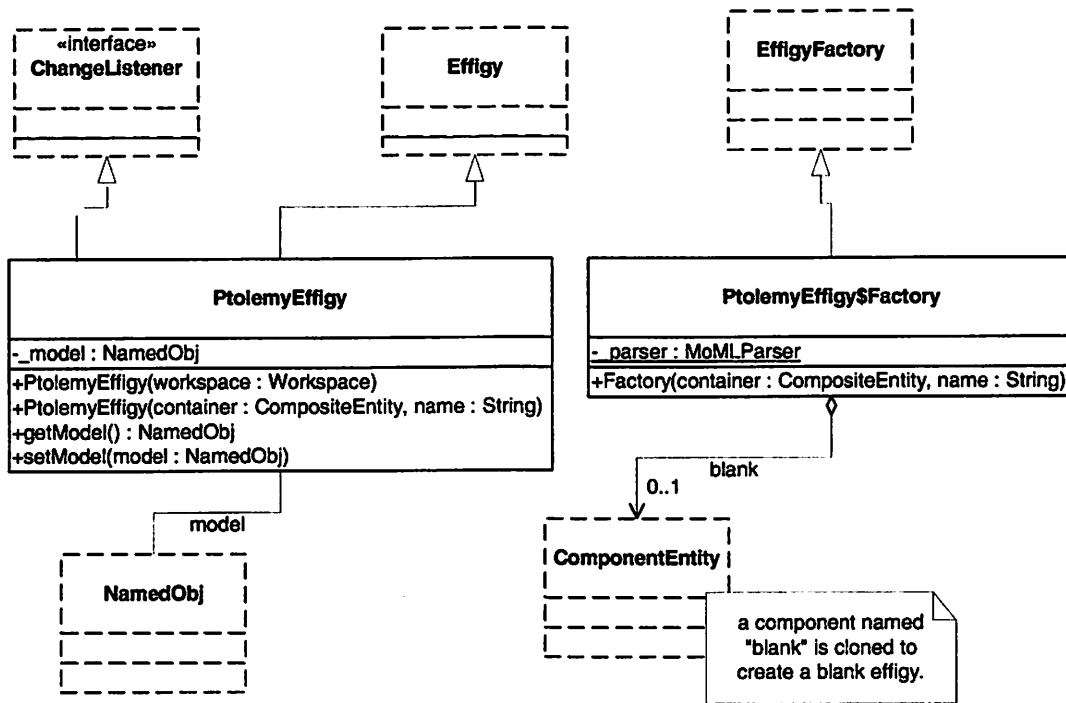

Figure 13.9 Static Structure for Ptolemy effigies.

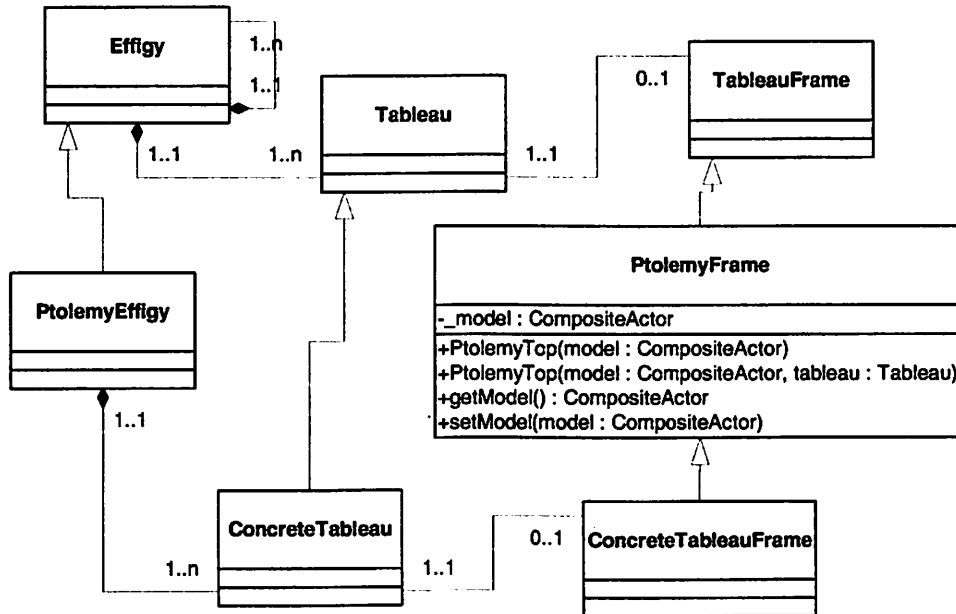

Figure 13.10 Static structure of the Ptolemy graph editor.

menus and the palette window) are created by the GraphFrame base class. This allows the code in GraphFrame to be reused with a different visual representation, such as the FSM editor described in Section 13.5.2.

13.5.2 FSM Tableau

The Ptolemy FSM editor graphically represents the the states and transitions of a Ptolemy FSM domain model. It allows syntax-directed editing of the model, along with links to important design

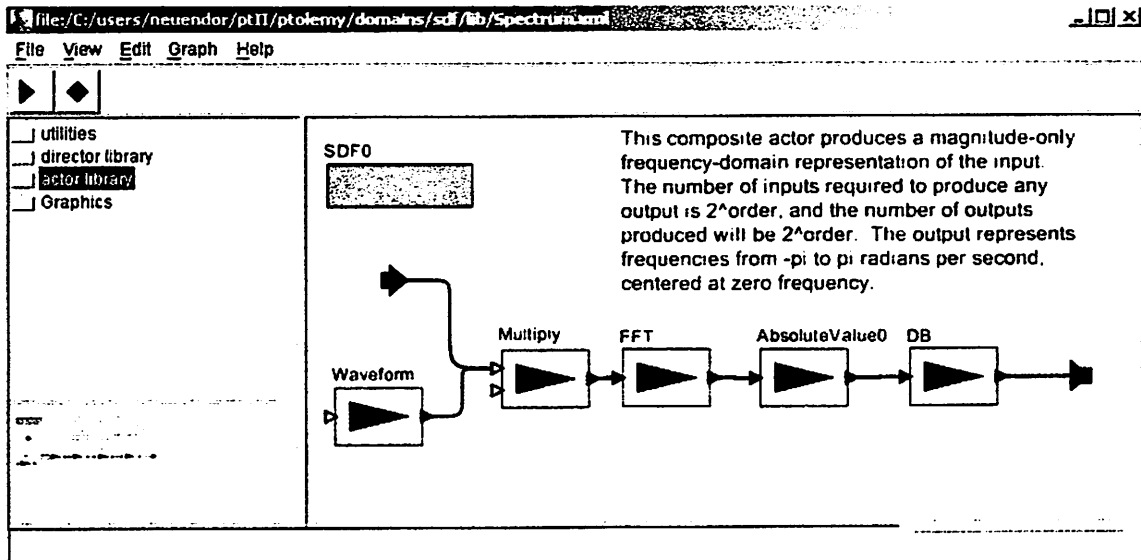

Figure 13.11 Vergil Screenshot.

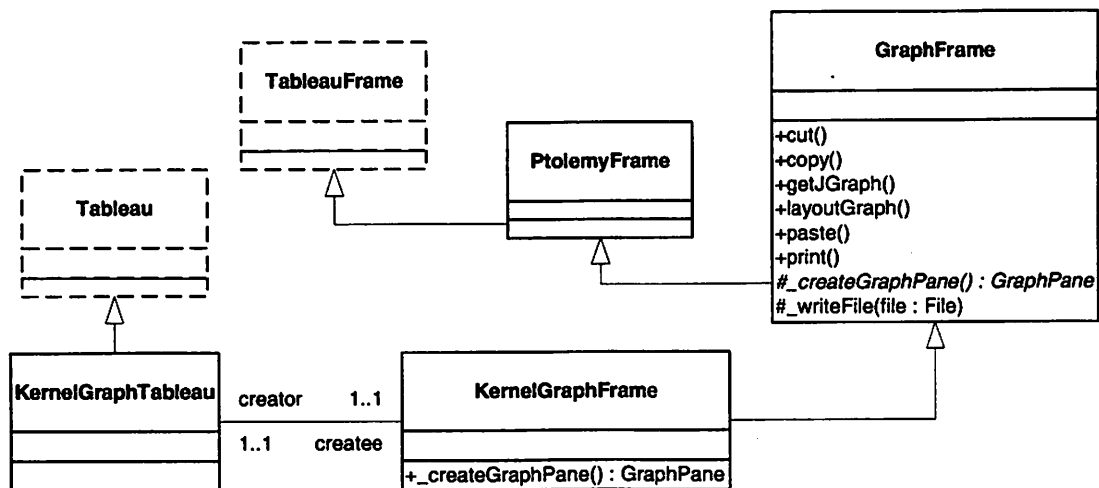

Figure 13.12 Static structure of the Ptolemy graph editor.

information, such as Actor source code and HTML documentation. A screen shot is shown in Figure 13.13. States can be added by control-clicking on the schematic, or by dragging and dropping from the palette on the left. Transitions are created by control dragging from an existing state.

The classes used to implement this tableau are shown in Figure 13.14. An instance of FSMGraphFrame is created by the tableau. The FSMGraphFrame class overrides the `_createGraphPane` factory

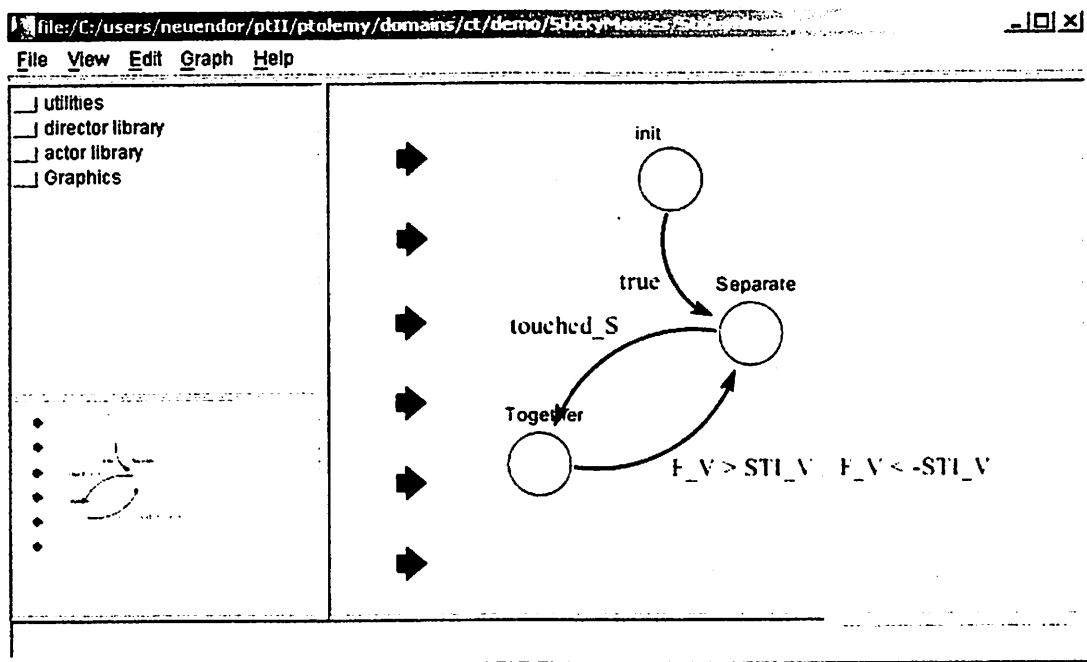

Figure 13.13 Vergil Screenshot.

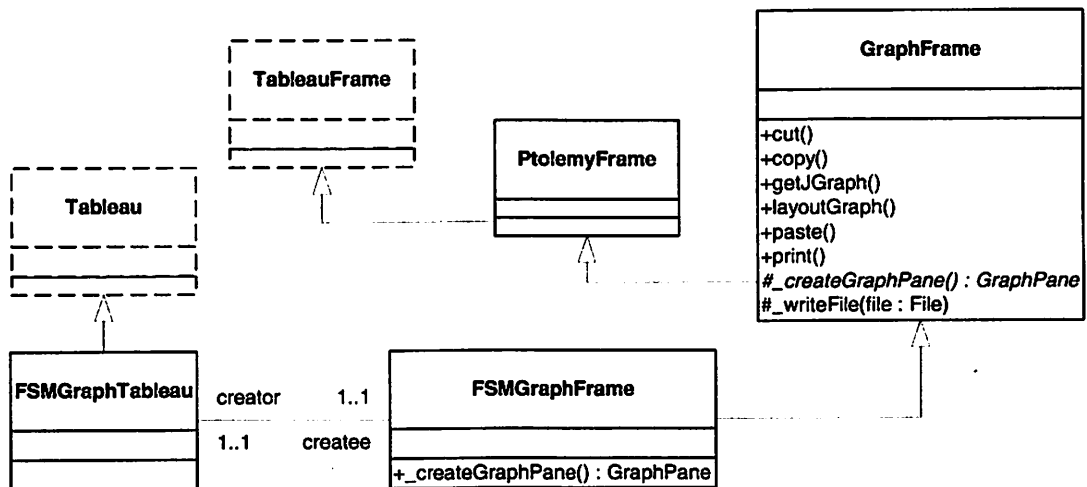

Figure 13.14 Static structure of the Ptolemy FSM graph editor.

method to create the graph editor itself, while most of the user interface components (like menus and the palette window) are created by the GraphFrame base class. Note the similarity to the KernelGraphFrame class described in section 13.5.1

13.5.3 Tree Tableau

Disregarding the relations between ports, a Ptolemy model is exactly the same as a hierarchical tree of entities, ports, and attributes. The Tree Editor graphically renders a Ptolemy model in just this way. It is most useful when the attributes of each object, or the hierarchy of objects needs to be emphasized. The current implementation of the Tree Tableau only allows browsing of the model, and is fairly incomplete. It is built using the swing JTree component, and the same base classes are used to display the palette in the Graph Editor described in section 13.5.1. The only difference is that the Tree Tableau uses a FullTreeModel, which includes both entities and attributes, while the palette uses an EntityTreeModel, which only includes entities. The static structure of the ptolemy.vergil.tree package is shown in Figure 13.12.

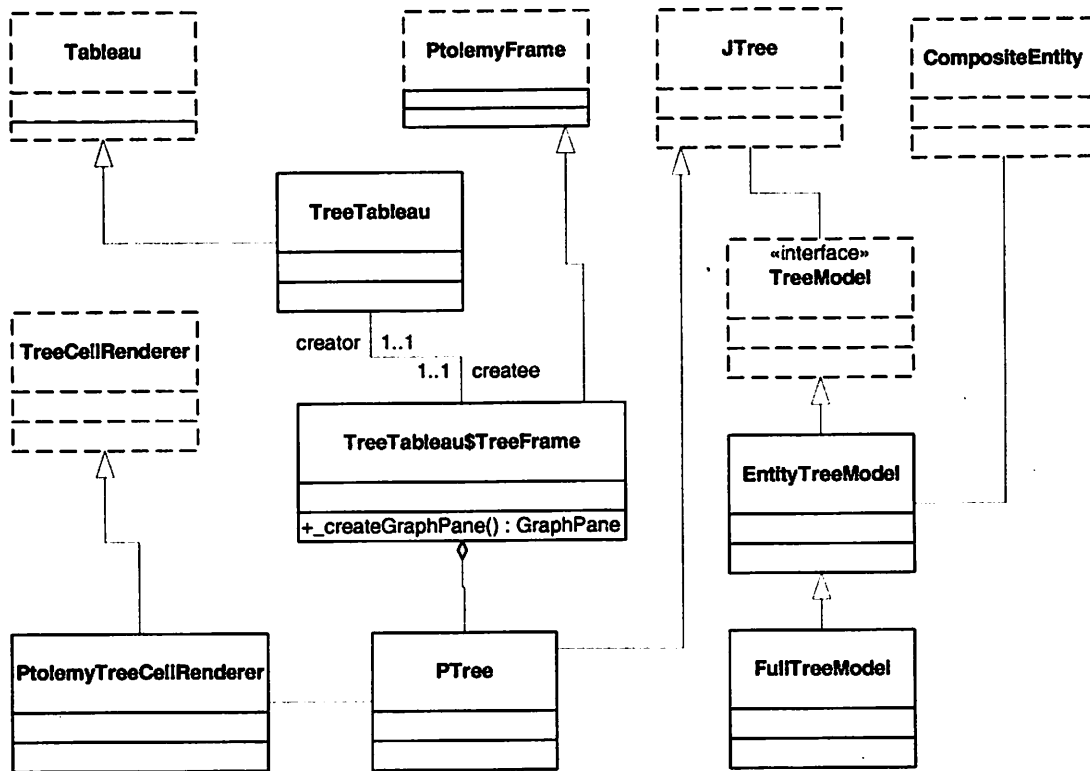

Figure 13.15 Static structure of the ptolemy.vergil.tree package.

PART 3:

DOMAINS

The chapters in this part describe existing Ptolemy domains. The domains implement models of computation, which are summarized in chapter 1. Most of these models of computation can be viewed as a framework for component-based design, where the framework defines the interaction mechanism between the components. Some of the domains (CSP, DDE, and PN) are thread-oriented, meaning that the components implement Java threads. These can be viewed, therefore, as abstractions upon which to build threaded Java programs. These abstractions are much easier to use (much higher level) than the raw threads and monitors of Java. Others (CT, DE, SDF) of the domains implement their own scheduling between actors, rather than relying on threads. This usually results in much more efficient execution. The non-threaded domains are described first, followed by the threaded domains. Within this grouping, the domains are ordered alphabetically (which is an arbitrary choice). The FSM domain is in a category by itself, since in it, the components are not producers and consumers of data, but rather are states.

41

MEMORANDUM

TO : SAC, [illegible]

FROM : [illegible]

RE : [illegible]

[illegible text]

[illegible text]

[illegible text]

[illegible text]

[illegible text]

[illegible text]

[illegible text]

[illegible text]

[illegible text]

[illegible text]

14

CT Domain

Author: Jie Liu

14.1 Introduction

The continuous-time (CT) domain in Ptolemy II aims to help the design and simulation of systems that can be modeled using ordinary differential equations (ODEs). ODEs are often used to model analog circuits, plant dynamics in control systems, lumped-parameter mechanical systems, lumped-parameter heat flows and many other physical systems.

Let's start with an example. Consider a second order differential system,

$$\begin{aligned} m\ddot{z}(t) + b\dot{z}(t) + kz(t) &= u(t) \quad . \\ y(t) &= c \cdot z(t) \\ z(0) &= 10, \dot{z}(0) = 0. \end{aligned} \quad (1)$$

The equations could be a model for an analog circuit as shown in figure 14.1(a), where z is the voltage

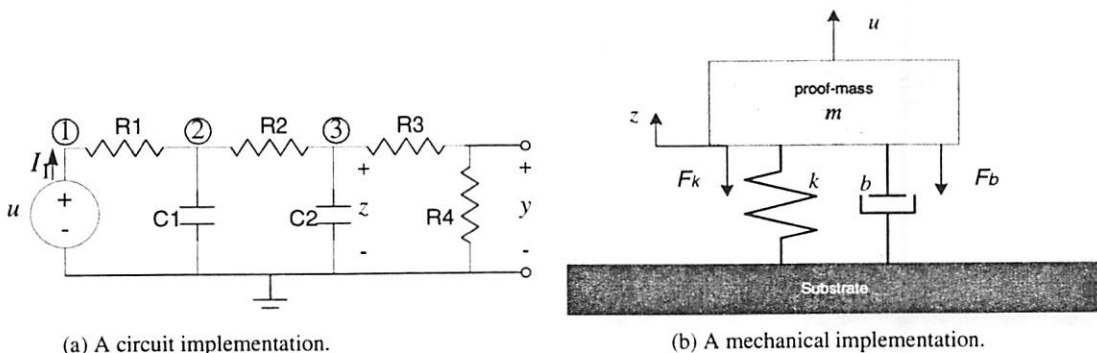

FIGURE 14.1. Possible implementations of the system equations.

of node 3, and

$$m = R1 \cdot R2 \cdot C1 \cdot C2 \quad (2)$$

$$k = R1 \cdot C1 + R2 \cdot C2$$

$$b = 1$$

$$c = \frac{R4}{R3 + R4}$$

Or it could be a lumped-parameter spring-mass mechanical model for the system shown in figure 14.1(b), where z is the position of the mass, m is the mass, k is the spring constant, b is the damping parameter, and $c = 1$.

In general, an ODE-based continuous-time system has the following form:

$$\dot{x} = f(x, u, t) \quad (3)$$

$$y = g(x, u, t) \quad (4)$$

$$x(t_0) = x_0, \quad (5)$$

where, $t \in \mathfrak{R}$, $t \geq t_0$, a real number, is *continuous time*. At any time t , $x \in \mathfrak{R}^n$, an n -tuple of real numbers, is the *state* of the system; $u \in \mathfrak{R}^m$ is the m -dimensional *input* of the system; $y \in \mathfrak{R}^l$ is the l -dimensional *output* of the system; $\dot{x} \in \mathfrak{R}^n$ is the derivative of x with respect to time t , i.e.

$$\dot{x} = \frac{dx}{dt}. \quad (6)$$

Equations (3), (4), and (5) are called the *system dynamics*, the *output map*, and the *initial condition* of the system, respectively.

For example, for the mechanical system above, if we define a vector

$$x(t) = \begin{bmatrix} z(t) \\ \dot{z}(t) \end{bmatrix}, \quad (7)$$

then system (1) can be written in form of (3)-(5), like

$$\dot{x}(t) = \frac{1}{m} \begin{bmatrix} 0 & 1 \\ -k & -b \end{bmatrix} x(t) + \begin{bmatrix} 0 \\ 1/m \end{bmatrix} u(t) \quad (8)$$

$$y(t) = \begin{bmatrix} c & 0 \end{bmatrix} x(t)$$

$$x(0) = \begin{bmatrix} 10 \\ 0 \end{bmatrix}.$$

The solution, $x(t)$, of the set of ODE (3)-(5), is a continuous function of time, also called a *waveform*, which satisfies the equation (3) and initial condition (5). The output of the system is then defined as a function of $x(t)$ and $u(t)$, which satisfies (4). The precise solution of a set of ODEs is usually impossible to be found using digital computers. Numerical solutions are approximations of the precise solution. A numerical solution of ODEs are usually done by integrating the right-hand side of (3) on a

discrete set of time points. Using digital computers to simulate continuous-time systems has been studied for more than three decades. One of the most well-known tools is Spice [69]. The CT domain differs from Spice-like continuous-time simulators in two ways — the system specification is somewhat different, and it is designed to interact with other models of computation.

14.1.1 System Specification

There are usually two ways to specify a continuous-time system, the conservation-law model and the signal-flow model [42]. The conservation-law models, like the nodal analysis in circuit simulation [39] and bond graphs [81] in mechanical models, define systems by their physical components, which specify relations of *cross* and *through* variables, and *conservation laws* are used to compile the component relations into global system equations. For example, in circuit simulation, the cross variables are voltages, the through variables are currents, and the conservation laws are Kirchhoff's laws. This model directly reflects the physical components of a system, thus is easy to construct from a potential implementation. The actual mathematical representation of the system is hidden. In signal-flow models, entities in a system are maps that define the mathematical relation between their input and output signals. Entities communicate by passing signals. This kind of models directly reflects the mathematical relations among signals, and is more convenient for specifying systems that do not have an explicit physical implementation yet.

In the CT domain of Ptolemy II, the signal-flow model is chosen as the interaction semantics. The conservation-law semantics may be used within an entity to define its I/O relation. There are four major reasons for this decision:

1. *The signal-flow model is more abstract.* Ptolemy II focuses on system-level design and behavior simulation. It is usually the case that, at this stage of a design, users are working with abstract mathematical models of a system, and the implementation details are unknown or not cared about.
2. *The signal flow model is more flexible and extensible,* in the sense that it is easy to embed components that are designed using other models. For example, a discrete controller can be modeled as a component that internally follows a discrete event model of computation but exposes a continuous-time interface.
3. *The signal flow model is consistent with other models of computation in Ptolemy II.* Most models of computation in Ptolemy use message-passing as the interaction semantics. Choosing the signal-flow model for CT makes it consistent with other domains, so the interaction of heterogeneous systems is easy to study and implement. This also allows domain polymorphic actors to be used in the CT domain.
4. *The signal flow model is compatible with the conservation law model.* For physical systems that are based on conservation laws, it is usually possible to wrap them into an entity in the signal flow model. The inputs of the entity are the excitations, like the current on ideal current sources, and the outputs are the variables that the rest of the system may be interested in.

The signal flow block diagram of the system (3) - (5) is shown in figure 14.2. The system dynamics (3) is built using integrators with feedback. In this figure, u , \dot{x} , x , and y , are continuous signals flowing from one block to the next. Notice that this diagram is only conceptual, most models may involve multiple integrators¹. Time is shared by all components, so it is not considered as an input. At any fixed time t , if the "snapshot" values $x(t)$ and $u(t)$ are given, then $\dot{x}(t)$ and $y(t)$ can be found by

1. Ptolemy II does not support vectorization in the CT domain yet.

evaluating f and g , which can be achieved by firing the respective blocks. The “snapshot” of all the signals at t is called the *behavior* of the system at time t .

The signal-flow model for the example system (1) is shown in figure 14.3. For comparison purpose, the conservation-law model (modified nodal analysis) of the system shown in figure 14.1(a) is shown in (9).

$$\begin{bmatrix} \frac{1}{R1} & -\frac{1}{R1} & 0 & 0 & -1 \\ -\frac{1}{R1} & \frac{1}{R1} + \frac{1}{R2} + C1 \frac{d}{dt} & -\frac{1}{R2} & 0 & 0 \\ 0 & -\frac{1}{R2} & \frac{1}{R2} + \frac{1}{R3} + C2 \frac{d}{dt} & -\frac{1}{R3} & 0 \\ 0 & 0 & -\frac{1}{R3} & \frac{1}{R3} + \frac{1}{R4} & 0 \\ 1 & 0 & 0 & 0 & 0 \end{bmatrix} \begin{bmatrix} v_1 \\ v_2 \\ v_3 \\ y \\ I_1 \end{bmatrix} = \begin{bmatrix} 0 \\ 0 \\ 0 \\ 0 \\ u \end{bmatrix} \quad (9)$$

By doing some math, we can see that (9) and (8) are in fact equivalent. Equation (9) can be easily assembled from the circuit, but it is more complicated than (8). Notice that in (9) d/dt is the derivative operator, which is replaced by an integration algorithm at each time step, and the system equations reduce to a set of algebraic equations. Spice software is known to have a very good simulation engine for models in form of (9).

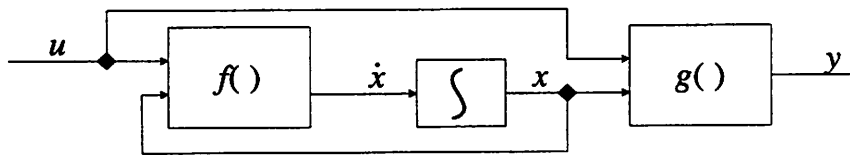

FIGURE 14.2. A conceptual block diagram for continuous time systems.

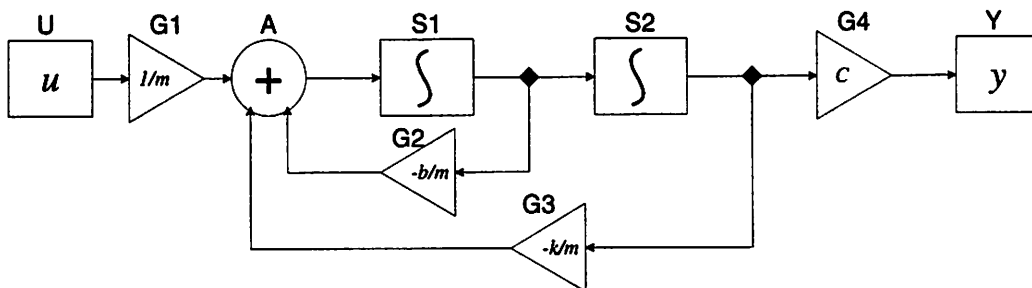

FIGURE 14.3. The block diagram for the example system.

14.1.2 Time

One distinct characterization of the CT model is the continuity of time. This implies that a continuous-time system have a behavior at any time instance. The simulation engine of the CT model should be able to compute the behavior of the system at any time point, although it may march discretely in time. In order to achieve an accurate simulation, time should be carefully discretized. The discretization of time, which appears as integration step sizes, may be determined by time points of interest (e.g. discontinuities), by the numerical error of integration, and by the convergence in solving algebraic equations.

Time is also global, which means that all components in the system share the same notion of time.

14.2 Solving ODEs numerically

We outline some basic terminologies on numerical ODE solving techniques that are used in this chapter. This is not a summary of numerical ODE solving theory. For a detailed treatment for ODEs and their numerical solutions, please refer to books on numerical solutions for ODEs, e.g. [29].

Not all ODEs have a solution, and some ODEs have more than one solution. In such situations, we say that the solution is not well defined. This is usually a result of errors in the system modeling. We restrict our discussion to systems that have unique solutions. Theorem 1 in Appendix F states the conditions for the existence and uniqueness of solutions of ODEs. Roughly speaking, we denote by D a set in \mathfrak{X} which contains at most a finite number of points per unit interval, and let u be piecewise-continuous on $\mathfrak{X} - D$. Then, for any fixed $u(t)$, if f is also piecewise-continuous on $\mathfrak{X} - D$, and f satisfies the Lipschitz condition (see e.g. [29]), then the ODE (3) with the initial condition (5) has a unique solution. The solution is called the *state trajectory* of the system. The key of simulating a continuous-time system numerically is to find an accurate numerical approximation of the state trajectory.

14.2.1 Basic Notations

Usually, only the solution on a finite time interval $[t_0, t_f]$ is needed. A simulation of the system is performed on discrete time points in this interval. We denote by

$$Tc = \{t_0, t_1, t_2, \dots, t_n, \dots, t_f\}, Tc \subset [t_0, t_f], \quad (10)$$

where

$$t_0 < t_1 < t_2 < \dots < t_n < \dots < t_f, \quad (11)$$

the set of the discrete time points of interest. To explicitly illustrate the discretization of time and the difference between the precise solution and the numerical solution, we use the following notation in the rest of the chapter:

- t_n : the n -th time point, to explicitly show the discretization of time. However, we write t , if the index n is not important.
- $x[t_i, t_j]$: the *precise* (continuous) state trajectory from time t_i to t_j ;
- $x(t_n)$: the *precise* solution of (3) at time t_n ;
- x_{t_n} : the *numerical* solution of (3) at time t_n ;
- $h_n = t_n - t_{n-1}$: step size of numerical integration. We also write h if the index n in the sequence

is not important. For accuracy reason, h may not be uniform.

- $\|x(t_n) - x_t\|$: the 2-normed difference between the precise solution and the numerical solution at step n is called the (*global*) *error* at step n ; the difference, when we assume $x_{t_0} \dots x_{t_{n-1}}$ are precise, is called the *local error* at step n . Local errors are usually easy to estimate and the estimation can be used for controlling the accuracy of numerical solutions.

A general way of numerically simulating a continuous-time system is to compute the state and the output of the system in an increasing order of t_n . Such algorithms are called the *time-marching* algorithms, and, in this chapter, we only consider these algorithms. There are variety of time marching algorithms that differ on how x_{t_n} is computed given $x_{t_0} \dots x_{t_{n-1}}$. The choice of algorithms is application dependent, and usually reflects the speed, accuracy, and numerical stability trade-offs.

14.2.2 Fixed-Point Behavior

Numerical ODE solving algorithms approximate the derivative operator in (3) using the history and the current knowledge on the state trajectory. That is, at time t_n , the derivative of x is approximated by a function of $x_{t_0}, \dots, x_{t_{n-1}}, x_{t_n}$, i.e.

$$\dot{x}_{t_n} = p(x_{t_0}, \dots, x_{t_{n-1}}, x_{t_n}). \quad (12)$$

Plugging (3) in this, we get

$$p(x_{t_0} \dots x_{t_{n-1}}, x_{t_n}) = f(x_{t_n}, u(t_n), t_n) \quad (13)$$

Depending on whether x_{t_n} explicitly appears in (13), the algorithms are called *explicit integration algorithms* or *implicit integration algorithms*. That is, we end up solving a set of algebraic equations in one of the two forms:

$$x_{t_n} = F_E(x_{t_0}, \dots, x_{t_{n-1}}) \quad (14)$$

or

$$F_I(x_{t_0}, \dots, x_{t_n}) = 0, \quad (15)$$

where F_E and F_I are derived from the time t_n , the input $u(t_n)$, the function f , and the history of x and \dot{x} . Solving (14) or (15) at a particular time t_n is called an *iteration* of the CT simulation at t_n .

Equation (14) can be solved simply by a function evaluation and an assignment. But the solution of (15) is the *fixed point* of F_I , which may not exist, may not be unique, or may not be able to be found. The *contraction mapping theorem* [13] shows the existence and uniqueness of the fixed-point solution, and provides one way to find it. Given the map F_I that is a local contraction map (generally true for small enough step sizes) and let an initial guess σ_0 be in the contraction radius, then a unique fixed point exists and can be found by iteratively computing:

$$\sigma_1 = F_E(\sigma_0), \sigma_2 = F_E(\sigma_1), \sigma_3 = F_E(\sigma_2), \dots \quad (16)$$

Solving both (14) and (15) should be thought of as finding the fixed-point behavior of the system at a particular time. This means both functions F_E and F_I should be smooth w.r.t. time, during one iteration of the simulation. This further implies that the topology of the system, all the parameters, and all the internal states that the firing functions depend on should be kept unchanged. We require that

domain polymorphic actors to update internal states only in the `postfire()` method exactly for this reason.

14.2.3 ODE Solvers Implemented

The following solvers has been implemented in the CT domain.

1. Forward Euler solver:

$$\begin{aligned} x_{t_{n+1}} &= x_{t_n} + h_{n+1} \cdot \dot{x}_{t_n} \\ &= x_{t_n} + h_{n+1} \cdot f(x_{t_n}, u_{t_n}, t_n) \end{aligned} \quad (17)$$

2. Backward Euler solver:

$$\begin{aligned} x_{t_{n+1}} &= x_{t_n} + h_{n+1} \cdot \dot{x}_{t_{n+1}} \\ &= x_{t_n} + h_{n+1} \cdot f(x_{t_{n+1}}, u_{t_{n+1}}, t_{n+1}) \end{aligned} \quad (18)$$

3. 2(3)-order Explicit Runge-Kutta solver

$$K_0 = h_{n+1} \cdot f(x_{t_n}, u_{t_n}, t_n) \quad (19)$$

$$K_1 = h_{n+1} \cdot f(x_{t_n} + K_0/2, u_{t_n} + h_{n+1}/2, t_n + h_{n+1}/2)$$

$$K_2 = h_{n+1} \cdot f(x_{t_n} + 3K_1/4, u_{t_n} + 3h_{n+1}/4, t_n + 3h_{n+1}/4)$$

$$\tilde{x}_{t_{n+1}} = x_{t_n} + \frac{2}{9}K_0 + \frac{1}{3}K_1 + \frac{4}{9}K_2$$

with error control:

$$K_3 = h_{n+1} \cdot f(\tilde{x}_{t_{n+1}}, u_{t_{n+1}}, t_{n+1}) \quad (20)$$

$$LTE = -\frac{5}{72}K_0 + \frac{1}{12}K_1 + \frac{1}{9}K_2 - \frac{1}{8}K_3$$

if $|LTE| < ErrorTolerance$, $x_{t_{n+1}} = \tilde{x}_{t_{n+1}}$, otherwise, fail. If this step is successful, the next integration step size is predicted by:

$$h_{n+2} = h_{n+1} \cdot \max(0.5, 0.8 \cdot \sqrt[3]{(ErrorTolerance)/|LTE|}) \quad (21)$$

4. Trapezoidal Rule solver:

$$\begin{aligned} x_{t_{n+1}} &= x_{t_n} + \frac{h_{n+1}}{2} (\dot{x}_{t_n} + \dot{x}_{t_{n+1}}) \\ &= x_{t_n} + \frac{h_{n+1}}{2} (\dot{x}_{t_n} + f(x_{t_{n+1}}, u_{t_{n+1}}, t_{n+1})) \end{aligned} \quad (22)$$

Among these solvers, 1) and 3) are explicit; 2) and 4) are implicit. Also, 1) and 2) do not perform step size control, so are called fixed-step-size solvers; 3) and 4) change step sizes according to error estimation, so are called variable-step-size solvers. Variable-step-size solvers adapt the step sizes according to changes of the system flow, thus are “smarter” than fixed-step-size solvers.

14.2.4 Discontinuity

The existence and uniqueness of the solution of an ODE (Theorem 1 in Appendix F) allows the right-hand side of (3) to be discontinuous at a countable number of discrete points D , which are called the *breakpoints* (also called the *discontinuous points* in some literature). These breakpoints may be caused by the discontinuity of input signal u , or by the intrinsic flow of f . In theory, the solutions at these points are not well defined. But the left and right limits are. So, instead of solving the ODE at those points, we would actually try to find the left and right limits.

One impact of breakpoints on ODE solvers is that history solutions are useless when approximating the derivative of x after the breakpoints. The solver should resolve the new initial conditions and start the solving process as if it is at a starting point. So, the discretization of time should step exactly on breakpoints for the left limit, and start at the breakpoint again after finding the right limit.

A breakpoint may be known beforehand, in which case it is called a *predictable breakpoint*. For example, a square wave source actor knows its next flip time. This information can be used to control the discretization of time. A breakpoint can also be *unpredictable*, which means it is unknown until the time it occurs. For example, an actor that varies its functionality when the input signal crosses a threshold can only report a “missed” breakpoint after an integration step is finished. How to handle breakpoints correctly is a big challenge for integrating continuous-time models with discrete models like DE and FSM.

14.2.5 Breakpoint ODE Solvers

Breakpoints in the CT domain are handled by adjusting integration steps. We use a table to handle predictable breakpoints, and use the step size control mechanism to handle unpredictable breakpoints. The breakpoint handling are transparent to users, and the implementation details (provided in section 14.7.4) are only needed when developing new directors, solvers, or event generators.

Since the history information is useless at breakpoints, special ODE solvers are designed to restart the numerical integration process. In particular, we have implemented the following breakpoint ODE solvers.

1. DerivativeResolver:

It calculates the derivative of the current state, i.e. $\frac{dx}{dt}$. This is simply done by evaluation the right-hand side of (3). At breakpoints, this solver is used for the first step to generate history information for explicit methods or one step methods.

2. ImpulseBESolver:

$$\begin{aligned} \tilde{x}_{t_{n+1}} &= x_{t_n} + h_{n+1} \cdot \dot{x}_{t_{n+1}} \\ x_{t_n^+} &= \tilde{x}_{t_{n+1}} - h_{n+1} \cdot \dot{x}_{t_n^+} \end{aligned} \quad (23)$$

The two time points t_n and t_n^+ have the same time value. This solver is used for breakpoints at which a Dirac impulse signal appears.

Notice that none of these solvers advance time. They can only be used at breakpoints.

14.3 CT Actors

A CT system can be built up using actors in the `ptolemy.domains.ct.lib` package and domain polymorphic actors that have continuous behaviors (i.e. all actors that do not implement the `SequenceActor` interface). The key actor in CT is the integrator. It serves the unique role of wiring up ODEs. Other actors in a CT system are usually stateless. A general understanding is that, in a pure continuous-time model, all the information — the state of the system— is stored in the integrators.

14.3.1 CT Actor Interfaces

In order to schedule the execution of actors in a CT model and to support the interaction between CT and other domains (which are usually discrete), we provide the following interfaces.

- **CTDynamicActor.** Dynamic actors are actors that contains continuous dynamics in their I/O path. An integrator is a dynamic actor, and so are all actors that have integration relations from their inputs to their outputs.
- **CTEventGenerator.** *Event generators* are actors that convert continuous time input signals to discrete output signals.
- **CTStatefulActor.** Stateful actors are actors that have internal states. The reason to classify this kind of actor is to support rollback, which may happen when a CT model is embedded in a discrete event model.
- **CTStepSizeControlActor.** Step size control actors influence the integration step size by telling the director whether the current step is accurate. The accuracy is in the sense of both tolerable numerical errors and absence of unpredictable breakpoints. It may also provide information about refining a step size for an inaccurate step and suggesting the next step size for an accurate step.
- **CTWaveformGenerator.** *Waveform generators* are actors that convert discrete input signals to continuous-time output signals.

Strictly speaking, event generators and waveform generators do not belong to any domain, but the CT domain is design to handle them intrinsically. When building systems, CT parts can always provide discrete interface to other domains.

Neither a loop of dynamic actors nor a loop of non-dynamic actors are allowed in a CT model. They introduce problems about the order that actors be executed. A loop of dynamic actors can be easily broken by a `Scale` actor with scale 1. A loop of non-dynamic actors builds an algebraic equation. The CT domain does not support modeling algebraic equations, yet.

14.3.2 Actor Library

1. **CTPeriodicalSampler.** This event generator periodically samples the input signal and generates events with the value of the input signal at these time points. The sampling rate is given by the *samplePeriod* parameter, which has default value 0.1. The sampling time points, which are known beforehand, are examples of predictable breakpoints.
2. **CTTriggeredSampler.** This actor samples the continuous input signal when there is a discrete event present at the "trigger" input.
3. **ContinuousTransferFunction.** A transfer function in the continuous time domain. This actor implements a transfer function where the single input (u) and single output (y) can be expressed in (Laplace) transfer function form as the following equation:

$$\frac{Y(s)}{U(s)} = \frac{b_1 s^{m-1} + b_2 s^{m-2} + \dots + b_m}{a_1 s^{n-1} + a_2 s^{n-2} + \dots + a_n} \quad (24)$$

where m and n are the number of numerator and denominator coefficients, respectively. This actor has two parameters – *numerator* and *denominator* – containing the coefficients of the numerator and denominator in descending powers of s . The parameters are double arrays. The order of the denominator (n) must be greater than or equal to the order of the numerator (m).

4. **DifferentialSystem.** The differential system model implements a system whose behavior is defined by:

$$\begin{aligned} \dot{x} &= f(x, u, t) \\ y &= g(x, u, t) \\ x(t_0) &= x_0 \end{aligned} \quad (25)$$

where x is the state vector, u is the input vector, and y is the output vector, t is the time. Users must give the name of the variables by filling in the parameter and add ports with proper names. The actor, upon creation, has no inputs and no outputs. After creating proper ports, their names can be used in the expressions of state equations and output equations. The name of the state variables are manually added by filling in the *stateVariableNames* parameter.

The state equations and output maps must be manually created by users as parameters. If there are n state variables $x_1 \dots x_n$, then users need to create n additional parameters, one for each state equation. And the parameters must be named as x_1_dot, \dots, x_n_dot , respectively. Similarly, if the output ports have names $y_1 \dots y_r$, then users must create additional r parameters for output maps. These parameters should be named y_1, \dots, y_r , respectively.

5. **Integrator:** The integrator for continuous-time simulation. An integrator has one input port and one output port. Conceptually, the input is the derivative of the output, and an ordinary differential equation is modeled as an integrator with feedback.

An integrator is a dynamic, step-size-control, and stateful actor. To help resolve new states from previous states, a set of variables are used:

- *state and its derivative:* These are the new state and its derivative at a time point, which have been confirmed by all the step size control actors.
- *tentative state and tentative derivative:* These are the state and derivative which have not been confirmed. It is a starting point for other actors to estimate the accuracy of this integration step.
- *history:* The previous states and derivatives. An integrator remembers the history states and their derivatives for the past several steps. The history is used by multistep methods.

An integrator has one parameter: *initialState*. At the initialization stage of the simulation, the state of the integrator is set to the initial state. Changes of *initialState* will be ignored after the simulation starts, unless the *initialize()* method of the integrator is called again. The default value of this parameter is 0.0. An integrator can possibly have several auxiliary variables. These auxiliary variables are used by ODE solvers to store intermediate states for individual integrators.

6. **LinearStateSpace.** The State-Space model implements a system whose behavior is defined by:

$$\begin{aligned}\dot{x} &= Ax + Bu \\ y &= Cx + Du \\ x(t_0) &= x_0\end{aligned}\tag{26}$$

where x is the state vector, u is the input vector, and y is the output vector. The matrix coefficients must have the following characteristics:

- A must be an n -by- n matrix, where n is the number of states.
- B must be an n -by- m matrix, where m is the number of inputs.
- C must be an r -by- n matrix, where r is the number of outputs.
- D must be an r -by- m matrix.

The actor accepts m inputs and generates r outputs through a multiple input port and a multiple output port. The widths of the ports must match the number of rows and columns in corresponding matrices, otherwise, an exception will be thrown.

7. **ZeroCrossingDetector.** This is an event generator that monitors the signal coming in from an input port – trigger. If the trigger is zero, then output the token from the input port. Otherwise, there is no output. This actor controls the integration step size to accurately resolve the time that the zero crossing happens. It has a parameter, *errorTolerance*, which controls how accurately the zero crossing is determined.
8. **ZeroOrderHold.** This is a waveform generator that converts discrete events into continuous signals. This actor acts as a zero-order hold. It consumes the token when the `consumeCurrentEvent()` is called. This value will be held and emitted every time it is fired, until the next time `consumeCurrentEvent()` is called. This actor has one single input port, one single output port, and no parameters.
9. **ThresholdMonitor.** This actor controls the integration steps so that the given threshold (on the input) is not crossed in one step. This actor has one input port and one output port. It has two parameters *thresholdWidth* and *thresholdCenter*, which have default value 1e-2 and 0, respectively. If the input is within the range defined by the threshold center and threshold width, then a true token is emitted from the output.

14.3.3 Domain Polymorphic Actors

Not all domain polymorphic actors can be used in the CT domain. Whether an actor can be used depends on how the internal states of the actor evolve when executing.

- **Stateless actors:** All stateless actors can be used in CT. In fact, most CT systems are built by integrators and stateless actors.
- **Timed actors:** Timed actors change their states according to the notion of time in the model. All actors that implement the `TimedActor` interface can be used in CT, as long as they do not also implement `SequenceActor`. Timed actors that can be used in CT include plotters that are designed to plot timed signals.
- **Sequence actors:** Sequence actors change their states according to the number of input tokens received by the actor and the number of times that the actor is postfired. Since CT is a time driven model, rather than a data driven model, the number of received tokens and the number of postfires do not have a significant semantic meaning. So, none of the sequence actors can be used in the CT domain. For example, the Ramp actor in Ptolemy II changes its state — the next token to emit —

corresponding to the number of times that the actor is postfired. In CT, the number of times that the actor is postfired depends on the discretization of time, which further depend on the choice of ODE solvers and setting of parameters. As a result, the slope of the ramp may not be a constant, and this may lead to very counterintuitive models. The same functionality is replaced by a Current-Time actor and a Scale actor. If sequence behaviors are indeed required, event generators and waveform generators may be helpful to convert continuous and discrete signals.

14.4 CT Directors

There are three CT directors — CTMultiSolverDirector, CTMixedSignalDirector, and CTEmbeddedDirector. The first one can only serve as a top-level director, a CTMixedSignalDirector can be used both at the top-level or inside a composite actor, and a CTEmbeddedDirector can only be contained in a CTCompositeActor. In terms of mixing models of computation, all the directors can execute composite actors that implement other models of computation, as long as the composite actors are properly connected (see section 14.5). Only CTMixedSignalDirector and CTEmbeddedDirector can be contained by other domains. The outside domain of a composite actor with CTMixedSignalDirector can be any discrete domain, such as DE, DT, etc. The outside domain of a composite actor with CTEmbeddedDirector must also be CT or FSM, if the outside domain of the FSM model is CT. (See also the HSDirector in the FSM domain.)

14.4.1 ODE Solvers

There are six ODE solvers implemented in the `ptolemy.domains.ct.kernel.solver` package. Some of them are specific for handling breakpoints. These solvers are ForwardEulerSolver, BackwardEulerSolver, ExplicitRK23Solver, TrapezoidalRuleSolver, DerivativeResolver, and ImpulseBESolver. They implement the ODE solving algorithms in section 14.2.3 and section 14.2.5, respectively.

14.4.2 CT Director Parameters

The CTDirector base class maintains a set of parameters which controls the execution. These parameters, shared by all CT directors, are listed in Table 21 on page 12. Individual directors may have their own (additional) parameters, which will be discussed in the appropriate sections.

Table 21: CTDirector Parameters

Name	Description	Type	Default Value
errorTolerance	The upper bound of local errors. Actors that perform integration error control (usually integrators in variable step size ODE solving methods) will compare the estimated local error to this value. If the local error estimation is greater than this value, then the integration step is considered inaccurate, and should be restarted with a smaller step sizes.	double	1e-4
initStepSize	This is the step size that users specify as the desired step size. For fixed step size solvers, this step size will be used in all non-breakpoint steps. For variable step size solvers, this is only a suggestion.	double	0.1
maxIterations	This is used to avoid the infinite loops in (implicit) fixed-point iterations. If the number of fixed-point iterations exceeds this value, but the fixed point is still not found, then the fixed-point procedure is considered failed. The step size will be reduced by half and the integration step will be restarted.	int	20

Table 21: CTDirector Parameters

Name	Description	Type	Default Value
maxStepSize	The maximum step size used in a simulation. This is the upper bound for adjusting step sizes in variable step-size methods. This value can be used to avoid sparse time points when the system dynamic is simple.	double	1.0
minStepSize	The minimum step size used in a simulation. This is the lower bound for adjusting step sizes. If this step size is used and the errors are still not tolerable, the simulation aborts. This step size is also used for the first step after breakpoints.	double	1e-5
startTime	The start time of the simulation. This is only applicable when CT is the top level domain. Otherwise, the CT director follows the time of its executive director.	double	0.0
stopTime	The stop time of the simulation. This is only applicable when CT is the top level domain. Otherwise, the CT director follows the time of its executive director.	double	Double. MAX_ VALUE
timeResolution	This controls the comparison of time. Since time in the CT domain is a double precision real number, it is sometimes impossible to reach or step at a specific time point. If two time points are within this resolution, then they are considered identical.	double	1e-10
valueResolution	This is used in (implicit) fixed-point iterations. If in two successive iterations the difference of the states is within this resolution, then the integration step is called converged, and the fixed point is considered reached.	double	1e-6

14.4.3 CTMultiSolverDirector

A CTMultiSolverDirector has two ODE solvers — one for ordinary use and one specifically for breakpoints. Thus, besides the parameters in the CTDirector base class, this class adds two more parameters as shown in Table 22 on page 13.

Table 22: Additional Parameter for CTMultiSolverDirector

Name	Description	Type	Default Value
ODESolver	The fully qualified class name for the ODE solver class.	string	"ptolemy.domains.ct.kernel.solver.ForwardEulerSolver"
breakpointODESolver	The fully qualified class name for the breakpoint ODE solver class.	string	"ptolemy.domains.ct.kernel.solver.DerivativeResolver"

A CTMultiSolverDirector can direct a model that has composite actors implementing other models of computation. One simulation iteration is done in two phases: the continuous phase and the discrete phase. Let the current iteration be n . In the continuous phase, the differential equations are integrated from time t_{n-1} to t_n . After that, in the discrete phase, all (discrete) events which happen at t_n are processed. The step size control mechanism will assure that no events will happen between t_{n-1} and t_n .

14.4.4 CTMixedSignalDirector

This director is designed to be the director when a CT subsystem is contained in an event-based system, like DE or DT. As proved in [57], when a CT subsystem is contained in the DE domain, the CT subsystem should run ahead of the global time, and be ready for rollback. This director implements this optimistic execution.

Since the outside domain is event-based, each time the embedded CT subsystem is fired, the input data are events. In order to convert the events to continuous signals, breakpoints have to be introduced. So this director extends CTMultiSolverDirector, which always has two ODE solvers. There is one more parameter used by this director — the *runAheadLength*, as shown in Table 23 on page 14.

Table 23: Additional Parameter for CTMixedSignalDirector

Name	Description	Type	Default Value
runAheadLength	The maximum length of time for the CT subsystem to run ahead of the global time.	double	1.0

When the CT subsystem is fired, the CTMixedSignalDirector will get the current time τ and the next iteration time τ' from the outer domain, and take the $\min(\tau - \tau', l)$ as the fire end time, where l is the value of the parameter *maxRunAheadLength*. The execution lasts as long as the fire end time is not reached or an output event is not detected.

This director supports rollback; that is when the state of the continuous subsystem is confirmed (by knowing that no events with a time earlier than the CT current time will be present), the state of the system is marked. If an optimistic execution is known to be wrong, the state of the CT subsystem will roll back to the latest marked state.

14.4.5 CTEmbeddedDirector

This director is used when a CT subsystem is embedded in another continuous time system, either directly or through a hierarchy of finite state machines, like in the hybrid system scenario [59]. This director can pass step size control information up to its executive director. To achieve this, the director must be contained in a CTCompositeActor, which implements the CTStepSizeControlActor interface and can pass the step size control information from the inner domain to the outer domain.

This director extends CTMultiSolverDirector, with no additional parameters. A major difference between this director and the CTMixedSignalDirector is that this director does not support rollback. In fact, when a CT subsystem is embedded in a continuous-time environment, rollback is not necessary.

14.5 Interacting with Other Domains

The CT domain can interact with other domains in Ptolemy II. In particular, we consider interaction among the CT domain, the discrete event (DE) domain and the finite state machine (FSM) domain. Following circuit design communities, we call a composition of CT and DE a *mixed-signal model*; following control and computation communities, we call a composition of CT and FSM a *hybrid system model*.

There are two ways to put CT and DE models together, depending on the containment relation. In either case, event generators and waveform generators are used to convert the two types of signals. Figure 14.4 shows a DE component wrapped by an event generator and a waveform generator. From the input/output point of view, it is a continuous time component. Figure 14.5 shows a CT subsystem wrapped by a waveform generator and an event generator. From the input/output point of view, it is a discrete event component. Notice that event generators and waveform generators always stay in the CT domain.

A hierarchical composition of FSM and CT is shown in figure 14.6. A CT component, by adopting

the event generation technique, can have both continuous and discrete signals as its output. The FSM can use predicates on these signals, as well as its own input signals, to build trigger conditions. The actions associated with transitions are usually setting parameters in the destination state, including the initial conditions of integrators.

14.6 CT Domain Demos

Here are some demos in the CT domain showing how this domain works and the interaction with other domains.

14.6.1 Lorenz System

The Lorenz System (see, for example, pp. 213-214 in [24]) is a famous nonlinear dynamic system that shows chaotic attractors. The system is given by:

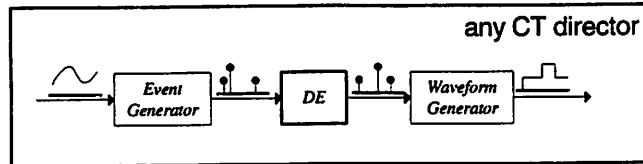

FIGURE 14.4. Embedding a DE component in a CT system.

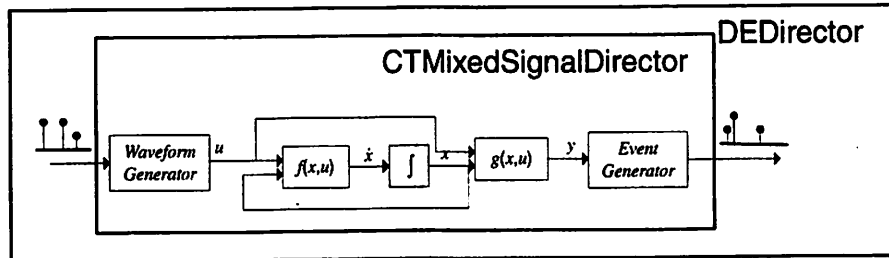

FIGURE 14.5. Embedding a CT component in a DE system.

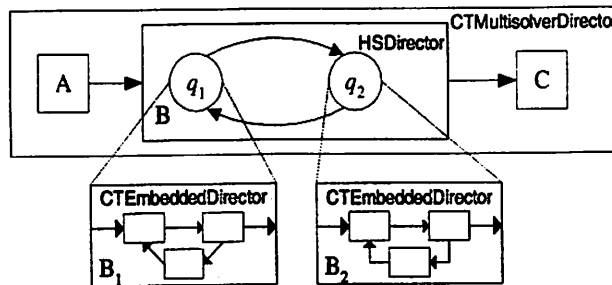

FIGURE 14.6. Hybrid system modeling.

$$\begin{aligned} \dot{x}_1 &= \sigma(x_2 - x_1) \\ \dot{x}_2 &= (\lambda - x_3)x_1 - x_2 \\ \dot{x}_3 &= x_1 \cdot x_2 - b \cdot x_3 \end{aligned} \tag{27}$$

The system is built by integrators and stateless domain polymorphic actors, as shown in figure 14.7.

The result of the state trajectory projecting onto the (x_1, x_2) plane is shown in figure 14.8. The initial conditions of the state variables are all 1.0. The default value of the parameters are: $\sigma = 1, \lambda = 25, b = 2.0$.

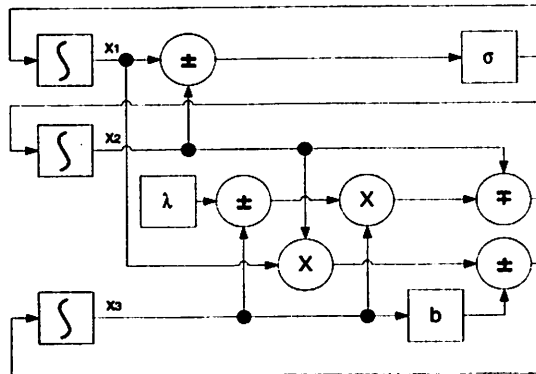

FIGURE 14.7. Block diagram for the Lorenz system.

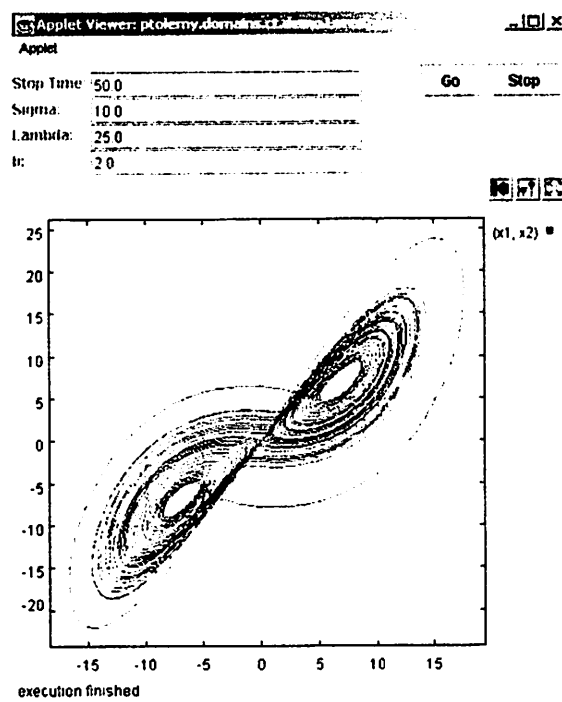

FIGURE 14.8. The simulation result of the Lorenz system.

14.6.2 Microaccelerometer with Digital Feedback.

Microaccelerometers are MEMS devices that use beams, gaps, and electrostatics to measure acceleration. Beams and anchors, separated by gaps, form parallel plate capacitors. When the device is accelerated in the sensing direction, the displacement of the beams causes a change of the gap size, which further causes a change of the capacitance. By measuring the change of capacitance (using a capacitor bridge), the acceleration can be obtained accurately. Feedback can be applied to the beams by charging the capacitors. This feedback can reduce the sensitivity to process variations, eliminate mechanical resonances, and increase sensor bandwidth, selectivity, and dynamic range.

Sigma-delta modulation [16], also called pulse density modulation or a bang-bang control, is a digital feedback technique, which also provides the A/D conversion functionality. Figure 14.9 shows the conceptual diagram of system. The central part of the digital feedback is a one-bit quantizer.

We implemented the system as Mark Alan Lemkin designed [56]. As shown in the figure 14.10, the second order CT subsystem is used to model the beam. The voltage on the beam-gap capacitor is sampled every T seconds (much faster than the required output of the digital signal), then filtered by a lead compensator (FIR filter), and fed to an one-bit quantizer. The outputs of the quantizer are converted to force and fed back to the beams. The outputs are also counted and averaged every NT seconds to produce the digital output. In our example, the external acceleration is a sine wave.

The execution result of the microaccelerometer system is shown in figure 14.11. The upper plot in the figure plots the continuous signals, where the low frequency (blue) sine wave is the acceleration

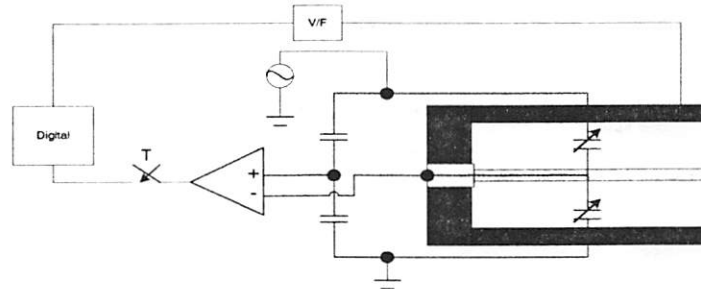

FIGURE 14.9. Micro-accelerator with digital feedback

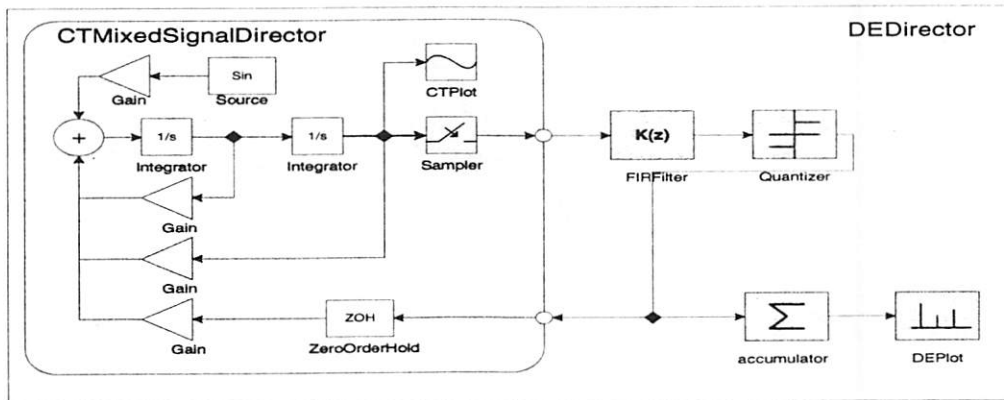

FIGURE 14.10. Block diagram for the micro-accelerator system.

input, the high frequency waveform (red) is the capacitance measurement, and the squarewave (green) is the zero-order hold of the feedback from the digital part. In the lower plot, the dense events (blue) are the quantized samples of the capacitance measurements, which has value +1 or -1, and the sparse events (red) are the accumulation and average of the previous 64 quantized samples. The sparse events are the digital output, and as expected, they have a sinusoidal shape.

14.6.3 Sticky Point Masses System

This sticky point mass demo shows a simple hybrid system. As shown in figure 14.12, there are two point masses on a frictionless table with two springs attaching them to fixed walls. Given initial positions other than the equilibrium points, the point masses oscillate. The distance between the two walls are close enough that the two point masses may collide. The point masses are sticky, in the way so that when they collide, they will sticky together and become one point mass with two springs attached to it. We also assume that the stickiness decays exponentially after the collision, such that

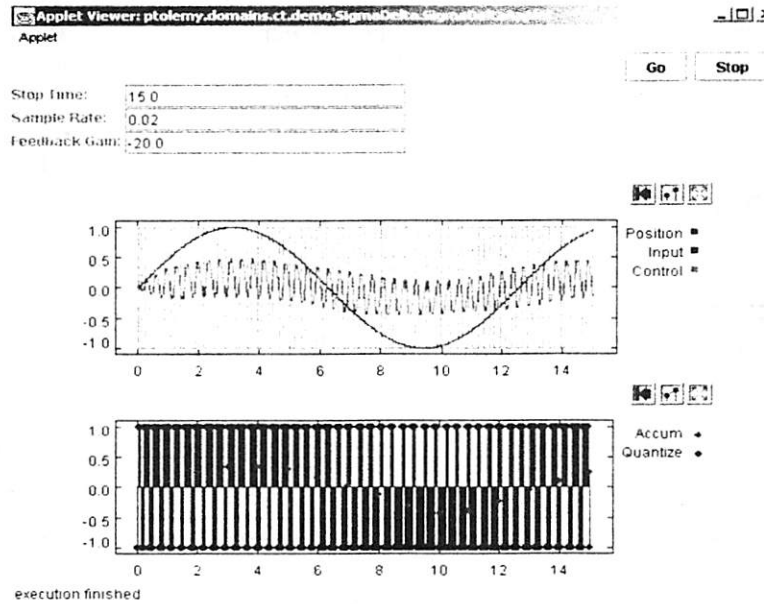

FIGURE 14.11. Execution result of the microaccelerometer system.

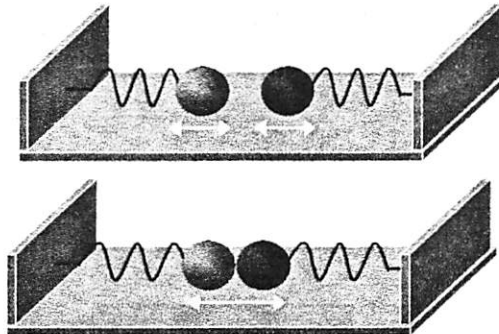

FIGURE 14.12. Sticky point masses system

eventually the pulling force between the two springs is big enough to pull the point masses apart. This separation gives the two point masses a new set of initial positions, and they oscillate freely until they collide again.

The system model, as shown in figure 14.13, has three levels of hierarchy — CT, FSM, and CT. The top level is a continuous time model with two actors, a CTCompositeActor that outputs the position of the two point masses, and a plotter that simply plots the trajectories. The composite actor is a finite state machine with two modes, *separated* and *together*.

In the separated state, there are two differential equations modeling two independently oscillating point masses. There is also an event detection mechanism, implemented by subtracting one position from another and comparing the result to zero. If the positions are equal, within a certain accuracy, then the two point masses collide, and a collision event is generated. This event will trigger a transition from the separated state to the together state. And the actions on the transition set the velocity of the stuck point mass based on Law of Conservation of Momentum.

In the together state, there is one differential equation modeling the stuck point masses, and another first order differential equation modeling the exponentially decaying stickiness. There is another expression computing the pulling force between the two springs. The guard condition from the together state to the separated state compares the pulling force to the stickiness. If the pulling force is bigger than the stickiness, then the transition is taken. The velocities of the two separated point masses equal to their velocities before the separation. The simulation result is shown in figure 14.14, where the position of the two point masses are plotted.

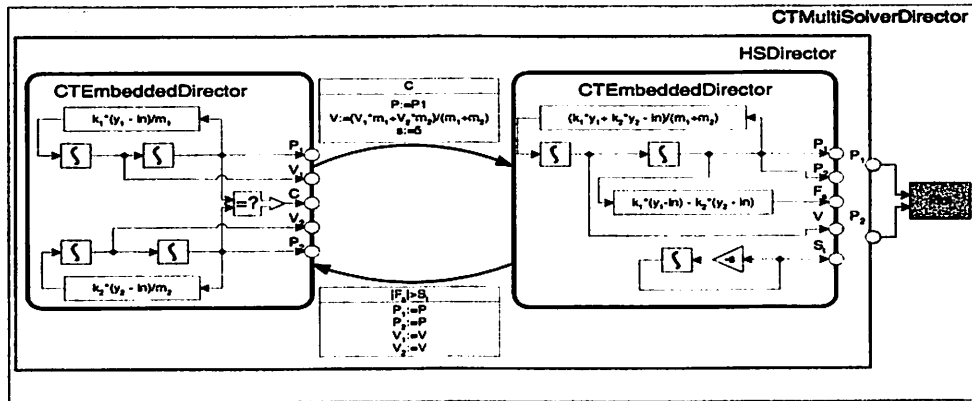

FIGURE 14.13. Modeling sticky point masses.

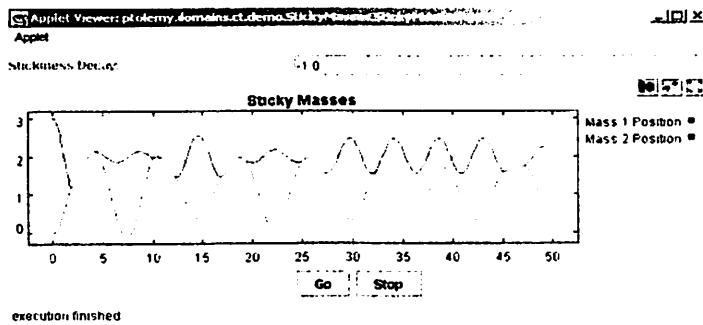

FIGURE 14.14. The simulation result of the sticky point masses system.

14.7 Implementation

The CT domain consists of the following packages, `ct.kernel`, `ct.kernel.util`, `ct.kernel.solver`, and `ct.lib`, as shown in figure 14.15.

14.7.1 `ct.kernel.util` package

The `ct.kernel.util` package provides a basic data structure — `TotallyOrderedSet`, which is used to store breakpoints. The UML for this package is shown in figure 14.16. A totally ordered set is a set (i.e. no duplicated elements) in which the elements are totally comparable. This data structure is used to store breakpoints since breakpoints are processed in their chronological order.

14.7.2 `ct.kernel` package

The `ct.kernel` package is the key package of the CT domain. It provides interfaces to classify actors, scheduler, director, and a base class for ODE solvers. The interfaces are used by the scheduler to generate schedules. The classes, including the `CTBaseIntegrator` class and the `ODESolver`

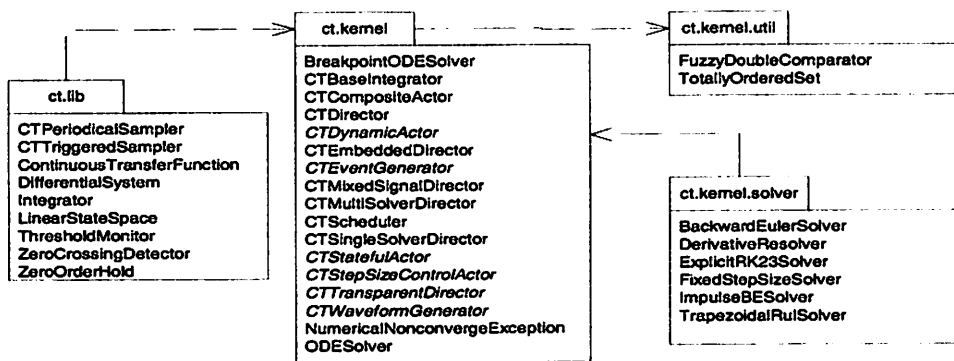

FIGURE 14.15. The packages in the CT domain.

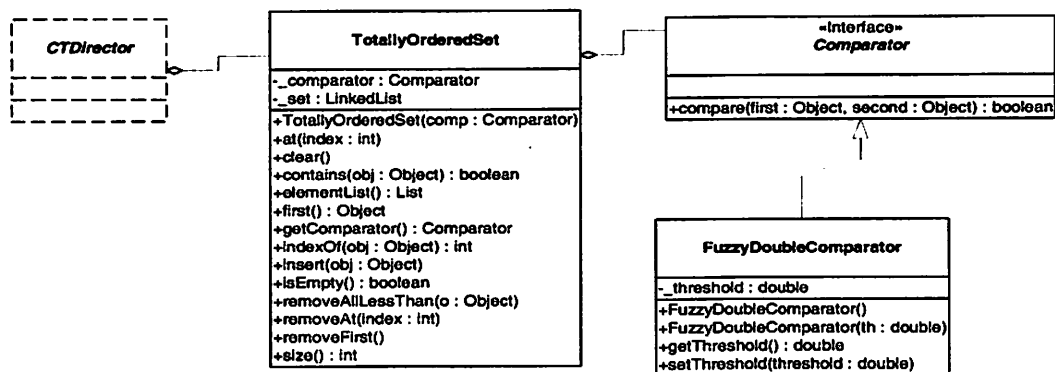

FIGURE 14.16. UML for `ct.kernel.util` package.

class, are shown in figure 14.17. Here, we use the delegation and the strategy design patterns [33][28] in the `CTBaseIntegrator` and the `ODESolver` classes to support seamlessly changing ODE solvers without reconstructing integrators. The execution methods of the `CTBaseIntegrator` class are delegated to the `ODESolver` class, and subclasses of `ODESolver` provide the concrete implementations of these methods, depending on the ODE solving algorithms.

CT directors implement the semantics of the continuous time execution. As shown in figure 14.18, directors that are used in different scenarios derive from the `CTDirector` base class. The `CTScheduler` class provides schedules for the directors.

The `ct.kernel.solver` package provides a set of ODE solvers. The classes are shown in figure 14.19. In order for the directors to choose among ODE solvers freely during the execution, the strategy design pattern is used again. A director class talks to the abstract `ODESolver` base class and individual ODE solver classes extend the `ODESolver` to provide concrete strategies.

14.7.3 Scheduling

This section and the following three sections provide technical details and design decisions made in the implementation of the CT domain. These details are only necessary if the readers want to implement new directors or ODE solvers.

In general, simulating a continuous-time system (3)-(5) by a time-marching ODE solver involves

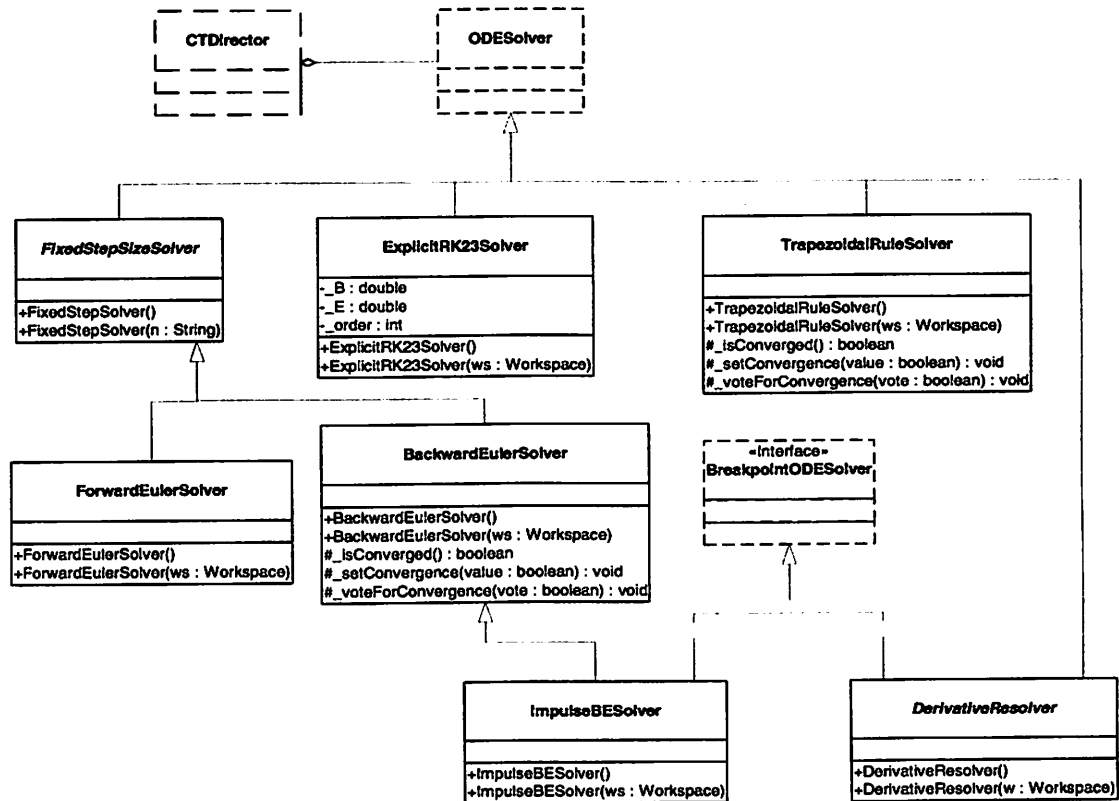

FIGURE 14.19. UML for `ct.kernel.solver` package.

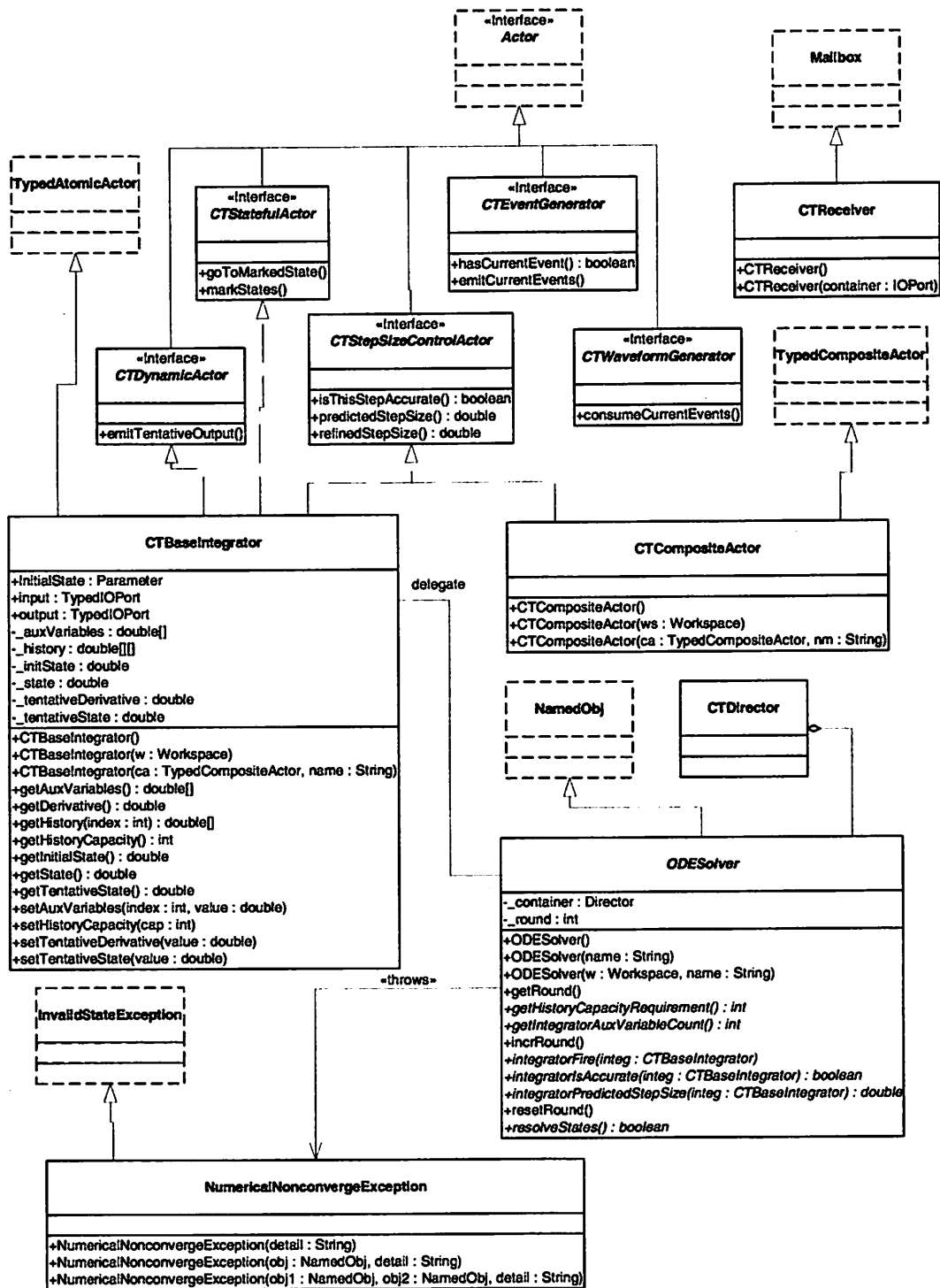

FIGURE 14.17. UML for ct.kernel package, actor related classes.

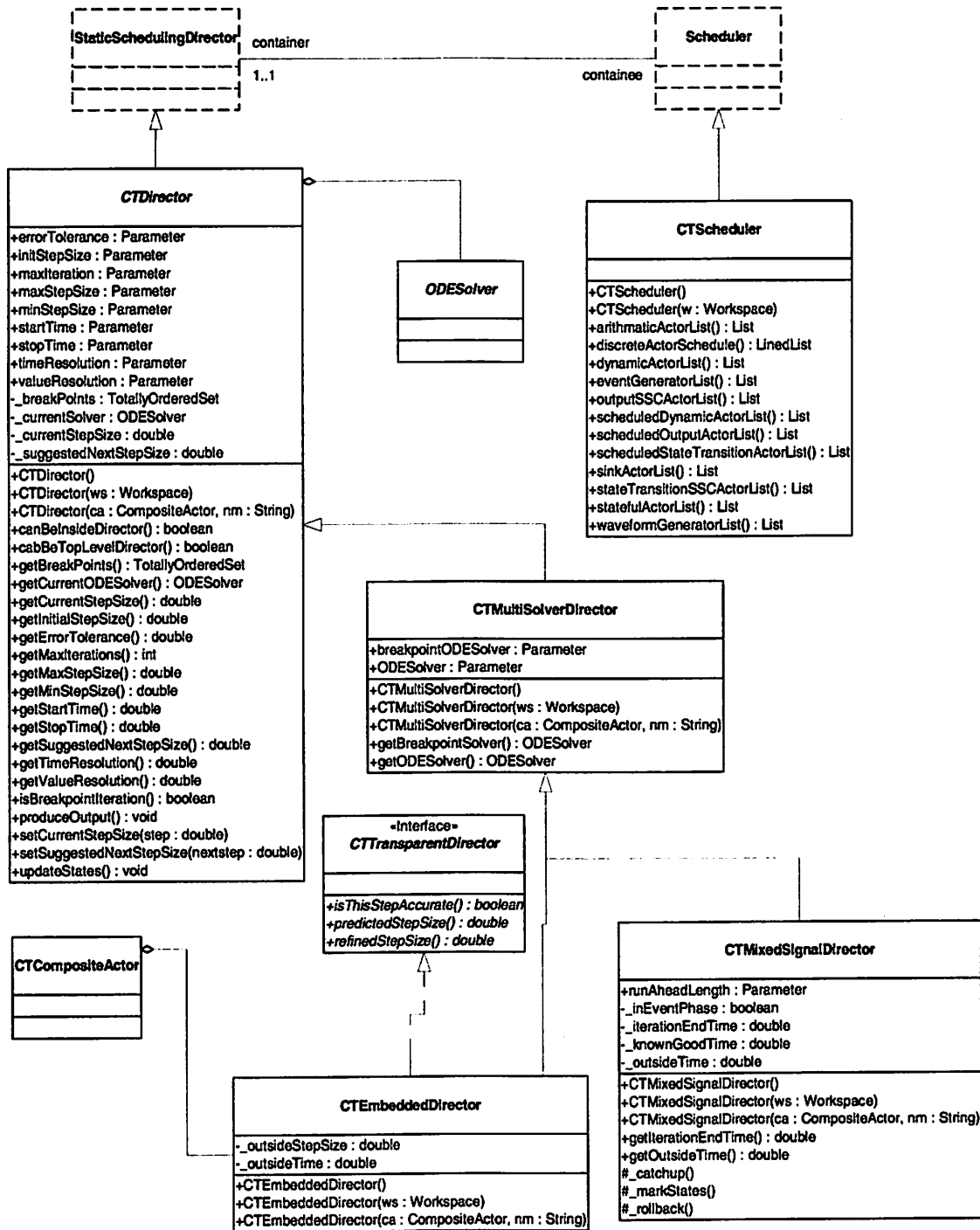

FIGURE 14.18. UML for ct.kernel package, director related classes.

the following execution steps:

1. Given the state of the system $x_{t_0} \dots x_{t_{n-1}}$ at time points $t_0 \dots t_{n-1}$, if the current integration step size is h , i.e. $t_n = t_{n-1} + h$, compute the new state x_{t_n} using the numerical integration algorithms. During the application of an integration algorithm, each evaluation of the $f(a, b, t)$ function is achieved by the following sequence:
 - Integrators emit tokens corresponding to a ;
 - Source actors emit tokens corresponding to b ;
 - The current time is set to t ;
 - The tokens are passed through the topology (in a data-driven way) until they reach the integrators again. The returned tokens are $\dot{x}|_{x=a} = f(a, b, t)$.
2. After the new state x_{t_n} is computed, test whether this step is successful. Local truncation error and unpredictable breakpoints are the issues to be concerned with, since those could lead to an unsuccessful step.
3. If the step is successful, predict the next step size. Otherwise, reduce the step size and try again.

Due to the signal-flow representation of the system, the numerical ODE solving algorithms are implemented as actor firings and token passings under proper scheduling.

The scheduler partitions a CT system into two clusters: the *state transition cluster* and the *output cluster*. In a particular system, these clusters may overlap.

The state transition cluster includes all the actors that are in the signal flow path for evaluating the f function in (3). It starts from the source actors and the outputs of the integrators, and ends at the inputs of the integrators. In other words, integrators, and in general dynamic actors, are used to break causality loops in the model. A topological sort of the cluster provides an enumeration of actors in the order of their firings. This enumeration is called the *state transition schedule*. After the integrators produce tokens representing x_t , one iteration of the state transition schedule gives the tokens representing $\dot{x}_t = f(x_t, u(t), t)$ back to the integrators.

The output cluster consists of actors that are involved in the evaluation of the output map g in (4). It is also similarly sorted in topological order. The *output schedule* starts from the source actors and the integrators, and ends at the sink actors.

For example, for the system shown in figure 14.3, the state transition schedule is

U-G1-G2-G3-A

where the order of G1, G2, and G3 are interchangeable. The output schedule is

G4-Y

The event generating schedule is empty.

A special situation that must be taken care of is the firing order of a chain of integrators, as shown in figure 14.20. For the implicit integration algorithms, the order of firings determines two distinct kinds of fixed point iterations. If the integrators are fired in the topological order, namely $x_1 \rightarrow x_2$ in our example, the iteration is called the *Gauss-Seidel iteration*. That is, x_2 always uses the new guess



FIGURE 14.20. A chain of integrators.

from x_1 in this iteration for its new guess. On the other hand, if they are fired in the reverse topological order, the iteration is called the *Gauss-Jacobi iteration*, where x_2 uses the tentative output from x_1 in the last iteration for its new estimation. The two iterations both have their pros and cons, which are thoroughly discussed in [71]. Gauss-Seidel iteration is considered faster in the speed of convergence than Gauss-Jacobi. For explicit integration algorithms, where the new states x_{t_n} are calculated solely from the history inputs up to $x_{t_{n-1}}$, the integrators must be fired in their reverse topological order. For simplicity, the scheduler of the CT domain, at this time, always returns the reversed topological order of a chain of integrators. This order is considered safe for all integration algorithms.

14.7.4 Controlling Step Sizes

Choosing the right time points to approximate a continuous time system behavior is one of the major tasks of simulation. There are three factors that may impact the choice of the step size.

- *Error control.* For all integration algorithms, the *local error* at time t_n is defined as a vector norm (say, the 2-norm) of the difference between the actual solution $x(t_n)$ and the approximation x_{t_n} calculated by the integration method, given that the last step is accurate. That is, assuming $x_{t_{n-1}} = x(t_{n-1})$ then

$$E_{t_n} = \|x_{t_n} - x(t_n)\|. \quad (28)$$

It can be shown that by carefully choosing the parameters in the integration algorithms, the local error is approximately of the p -th order of the step size, where p , an integer closely related to the number of f function evaluations in one integration step, is called the *order* of the integration algorithm, i.e. $E_{t_n} \sim O((t_n - t_{n-1})^p)$. Therefore, in order to achieve an accurate solution, the step size should be chosen to be small. But on the other hand, small step sizes means long simulation time. In general, the choice of step size reflects the trade-off between speed and accuracy of a simulation.

- *Convergence.* The local contraction mapping theorem (Theorem 2 in Appendix F) shows that for implicit ODE solvers, in order to find the fixed point at t_n , the map $F_f(\cdot)$ in (15) must be a (local) contraction map, and the initial guess must be within an ϵ ball (the contraction radius) of the solution. It can be shown that $F_f(\cdot)$ can be made contractive if the step size is small enough. (The choice of the step size is closely related to the Lipschitz constant). So the general approach for resolving the fixed point is that if the iterating function $F_f(\cdot)$ does not converge at one step size, then reduce the step size by half and try again.
- *Discontinuity.* At discontinuous points, the derivatives of the signals are not continuous, so the integration formula is not applicable. That means the discontinuous points can not be crossed by one integration step. In particular, suppose the current time is t and the intended next time point is $t+h$. If there is a discontinuous point at $t + \delta$, where $\delta < h$, then the next step size should be reduced to $t + \delta$. For a predictable breakpoint, the director can adjust the step size accordingly before starting an integration step. However for an unpredictable breakpoint, which is reported "missed" after an integration step, the director should be able to discard its last step and restart with a smaller step size to locate the actual discontinuous point.

Notice that convergence and accuracy concerns only apply to some ODE solvers. For example, explicit algorithms do not have the convergence problem, and fixed step size algorithms do not have the error control capability. On the other hand, discontinuity control is a generic feature that is independent on the choice of ODE solvers.

14.7.5 Mixed-Signal Execution

DE inside CT.

Since time advances monotonically in CT and events are generated chronologically, the DE component receives input events monotonically in time. In addition, a composition of causal DE components is causal [50], so the time stamps of the output events from a DE component are always greater than or equal to the global time. From the view point of the CT system, the events produced by a DE component are predictable breakpoints.

Note that in the CT model, finding the numerical solution of the ODE at a particular time is semantically an instantaneous behavior. During this process, the behavior of all components, including those implemented in a DE model, should keep unchanged. This implies that the DE components should not be executed during one integration step of CT, but only between two successive CT integration steps.

CT inside DE.

When a CT component is contained in a DE system, the CT component is required to be causal, like all other components in the DE system. Let the CT component have local time t , when it receives an input event with time stamp τ . Since time is continuous in the CT model, it will execute from its local time t , and may generate events at any time greater or equal to t . Thus we need

$$t \geq \tau \quad (29)$$

to ensure causality. This means that the local time of the CT component should always be greater than or equal to the global time whenever it is executed.

This ahead-of-time execution implies that the CT component should be able to remember its past states and be ready to rollback if the input event time is smaller than its current local time. The state it needs to remember is the state of the component after it has processed an input event. Consequently, the CT component should not emit detected events to the outside DE system before the global time reaches the event time. Instead, it should send a pure event to the DE system at the event time, and wait until it is safe to emit it.

14.7.6 Hybrid System Execution

Although FSM is an untimed model, its composition with a timed model requires it to transfer the notion of time from its external model to its internal model. During continuous evolution, the system is simulated as a CT system where the FSM is replaced by the continuous component refining the current FSM state. After each time point of CT simulation, the triggers on the transitions starting from the current FSM state are evaluated. If a trigger is enabled, the FSM makes the corresponding transition. The continuous dynamics of the destination state is initialized by the actions on the transition. The simulation continues with the transition time treated as a breakpoint.

Appendix F: Brief Mathematical Background

Theorem 1. [Existence and uniqueness of the solution of an ODE] Consider the initial value ODE problem

$$\begin{aligned}\dot{x} &= f(x, t) \\ x(t_0) &= x_0\end{aligned}\quad (30)$$

If f satisfies the conditions:

1. [*Continuity Condition*] Let D be the set of possible discontinuity points; it may be empty. For each fixed $x \in \mathfrak{R}^n$ and $u \in \mathfrak{R}^m$, the function $f: \mathfrak{R} \setminus D \rightarrow \mathfrak{R}^n$ in (30) is continuous. And $\forall \tau \in D$, the left-hand and right-hand limit $f(x, u, \tau^-)$ and $f(x, u, \tau^+)$ are finite.
2. [*Lipschitz Condition*] There is a piecewise continuous bounded function $k: \mathfrak{R} \rightarrow \mathfrak{R}^+$, where \mathfrak{R}^+ is the set of non-negative real numbers, such that $\forall t \in \mathfrak{R}, \forall \zeta, \xi \in \mathfrak{R}^n, \forall u \in \mathfrak{R}^m$

$$\|f(\xi, u, t) - f(\zeta, u, t)\| \leq k(t) \|\xi - \zeta\|. \quad (31)$$

Then, for each initial condition $(t_0, x_0) \in \mathfrak{R} \times \mathfrak{R}^n$ there exists a *unique* continuous function $\psi: \mathfrak{R} \rightarrow \mathfrak{R}^n$ such that,

$$\psi(t_0) = x_0 \quad (32)$$

and

$$\dot{\psi}(t) = f(\psi(t), u(t), t) \quad \forall t \in \mathfrak{R} \setminus D. \quad (33)$$

This function $\psi(t)$ is called the *solution* through (t_0, x_0) of the ODE (30).



Theorem 2. [Contraction Mapping Theorem.] If $F: \mathfrak{R}^n \rightarrow \mathfrak{R}^n$ is a local contraction map at x with contraction radius ε , then there exists a unique fixed point of F within the ε ball centered at x . I.e. there exists a unique $\sigma \in \mathfrak{R}^n$, $\|\sigma - x\| \leq \varepsilon$, such that $\sigma = F(\sigma)$. And $\forall \sigma_0 \in \mathfrak{R}^n$, $\|\sigma_0 - x\| \leq \varepsilon$, the sequence

$$\sigma_1 = F(\sigma_0), \sigma_2 = F(\sigma_1), \sigma_3 = F(\sigma_2), \dots \quad (34)$$

converges to σ .

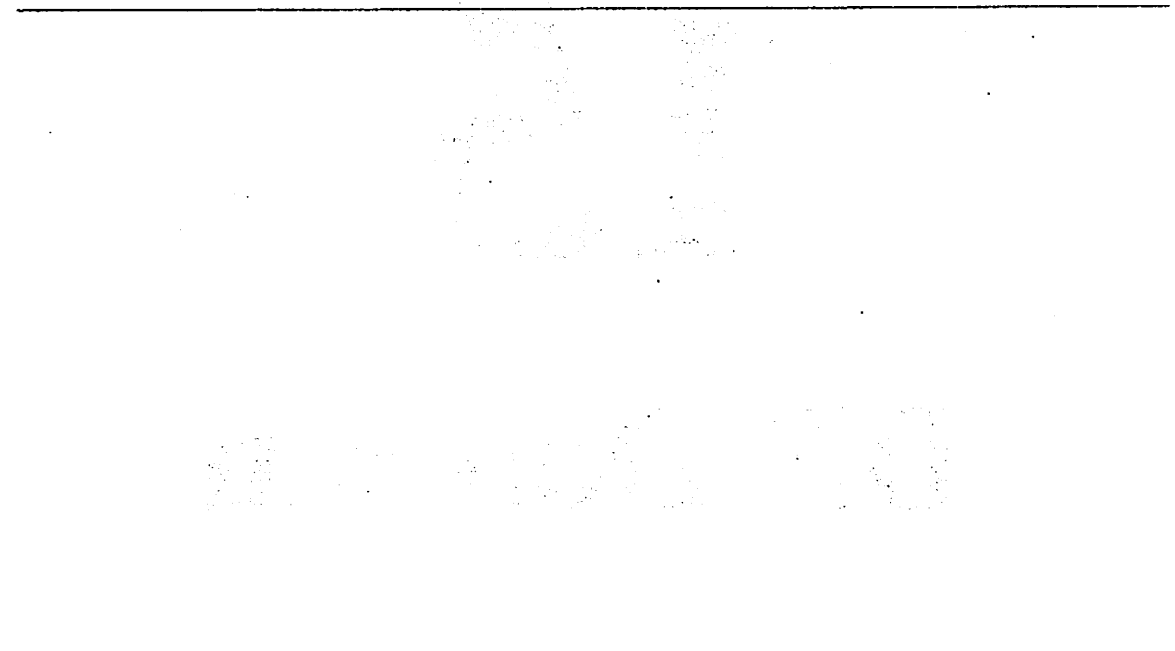

[The text in this section is extremely faint and illegible due to low contrast and scan quality. It appears to be a multi-column layout of text, possibly a description or legend related to the diagram above.]

15

DE Domain

Authors: *Lukito Muliadi*
 Edward A. Lee

15.1 Introduction

The discrete-event (DE) domain supports time-oriented models of systems such as queuing systems, communication networks, and digital hardware. In this domain, actors communicate by sending *events*, where an event is a data value (a token) and a *time stamp*. A DE scheduler ensures that events are processed chronologically according to this time stamp by firing those actors whose available input events are the oldest (having the earliest time stamp of all pending events).

A key strength in our implementation is that simultaneous events (those with identical time stamps) are handled systematically and deterministically. A second key strength is that the global event queue uses an efficient structure that minimizes the overhead associated with maintaining a sorted list with a large number of events.

15.1.1 Model Time

In the DE model of computation, time is *global*, in the sense that all actors share the same global time. The *current time* of the model is often called the *model time* or *simulation time* to avoid confusion with current real time.

As in most Ptolemy II domains, actors communicate by sending tokens through ports. Ports can be input ports, output ports, or both. Tokens are sent by an output port and received by all input ports connected to the output port through relations. When a token is sent from an output port, it is packaged as an event and stored in a global event queue. By default, the time stamp of an output is the model time, although specialized DE actors can produce events with future time stamps.

Actors may also request that they be fired at some time in the future by calling the `fireAt()` method of the director. This places a *pure event* (one with a time stamp, but no data) on the event queue. A pure event can be thought of as setting an alarm clock to be awakened in the future. Sources (actors with no

inputs) are thus able to be fired despite having no inputs to trigger a firing. Moreover, actors that introduce *delay* (outputs have larger time stamps than the inputs) can use this mechanism to schedule a firing in the future to produce an output.

In the global event queue, events are sorted based on their time stamps. An event is removed from the global event queue when the *model time* reaches its time stamp, and if it has a data token, then that token is put into the destination input port.

At any point in the execution of a model, the events stored in the global event queue have time stamps greater than or equal to the model time. The DE director is responsible for advancing (i.e. incrementing) the model time when all events with time stamps equal to the current model time have been processed (i.e. the global event queue only contains events with time stamps strictly greater than the current time). The current time is advanced to the smallest time stamp of all events in the global event queue.

15.1.2 Simultaneous events

An important aspect of a DE domain is the prioritizing of simultaneous events. This gives the domain a dataflow-like behavior for events with identical time stamps. It is done by assigning a *depth* to each actor and a *microstep* to each phase of execution within a given time stamp. Each depth is a non-negative integer, uniquely assigned; i.e. no two actors are assigned the same depth.

The depth of an actor determines the *priority* of events destined to that actor, relative to other events with the same time stamp and the same microstep. The highest priority events are those destined to actors with the lowest depth.

Consider the simple topology shown in figure 15.1. Assume that actor *Y* is not a delay actor, meaning that its output events have the same time stamp and microstep as its input events (this is suggested by the dotted arrow). Suppose that actor *X* produces an event with time stamp τ . That event is available at ports *B* and *D*, so the scheduler could choose to fire actors *Y* or *Z*. Which should it fire? Intuition tells us it should fire the upstream one first, *Y*, because that firing may produce another event with time stamp τ at port *D* (which is presumably a multiport). It seems logical that if actor *Z* is going to get one event on each input channel with the same time stamp, then it should see those events in the same firing. Thus, if there are simultaneous events at *B* and *D*, then the one at *B* will have higher priority.

The depths are determined by a *topological sort* of a *directed acyclic graph* (DAG) of the actors. The DAG of actors follows the topology of the graph, except when there are declared delays. Once the DAG is constructed, it is sorted topologically. This simply means that an ordering of actors is assigned such that an upstream actor in the DAG is earlier in the ordering than a downstream actor. The depth of an actor is defined to be its position in this topological sort, starting with zero. For example, in figure 15.1, *X* will have depth 0, *Y* will have depth 1, and *Z* will have depth 2.

In general, a DAG has several correct topological sorts. The topological sort is not unique, mean-

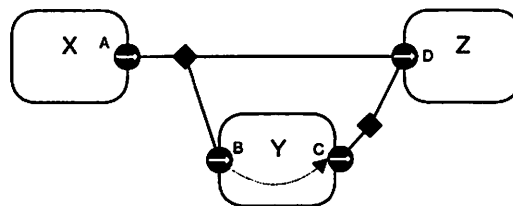

FIGURE 15.1. If there are simultaneous events at *B* and *D*, then the one at *B* will have higher priority because it may trigger another simultaneous event at *D*.

ing that the depths assigned to actors are somewhat arbitrary. But an upstream actor will always have a lower depth than a downstream actor, unless there is an intervening delay actor. Thus, given simultaneous input events with the same microstep, an upstream actor will always fire before a downstream actor. Such a strategy ensures that the execution is *deterministic*, assuming the actors only communicate via events. In other words, even though there are several possible choices that a scheduler could make for an ordering of firings, all choices that respect the priorities yield the same results.

There are situations where constructing a DAG following the topology is not possible. Consider the topology shown in figure 15.2. It is evident from the figure that the topology is not acyclic. Indeed, figure 15.2 depicts a *zero-delay loop* where topological sort cannot be done. The director will refuse to run the model, and will terminate with an error message.

The TimedDelay actor in DE is a domain-specific actor that asserts a delay relationship between its input and output. Thus, if we insert a TimedDelay actor in the loop, as shown in figure 15.3, then constructing the DAG becomes once again possible. The TimedDelay actor breaks the precedences.

Note in particular that the TimedDelay actor breaks the precedences *even if its delay parameter is set to zero*. Thus, the DE domain is perfectly capable of modeling feedback loops with zero time delay, but the model builder has to specify the order in which events should be processed by placing a TimedDelay actor with a zero value for its parameter.

15.1.3 Iteration

At each iteration, after advancing the current time, the director chooses all events in the global event queue that have the smallest time stamps, microstep, and depth (tested in that order). The chosen events are then removed from the global event queue and their data tokens are inserted into the appropriate input ports of the destination actor. Then, the director iterates the destination actor; i.e. it invokes `prefire()`, `fire()`, and `postfire()`. All of these events are destined to the same actor, since the depth is unique for each actor.

A firing may produce additional events at the current model time (the actor reacts *instantaneously*, or has *zero delay*). There also may be other events with time stamp equal to the current model time still pending on the event queue. The DE director repeats the above procedure until there are no more

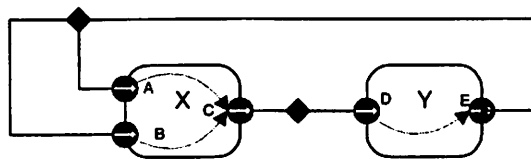

FIGURE 15.2. An example of a directed zero-delay loop.

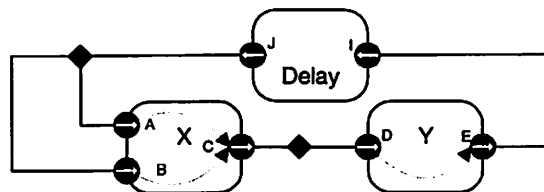

FIGURE 15.3. A Delay actor can be used to break a zero-delay loop.

events with time stamp equal to the current time. This concludes one iteration of the model. An iteration, therefore, processes all events on the event queue with the smallest time stamp.

15.1.4 Getting a Model Started

Before one of the iterations described above can be run, there have to be initial events in the global event queue. Actors may produce initial pure events or regular output events in their `initialize()` method. Thus, to get a model started, at least one actor must produce events. All the domain-polymorphic timed sources described in the Actor Libraries chapter produce pure events, so these can be used in DE. We can define the *start time* to be the smallest time stamp of these initial events.

15.1.5 Pure Events at the Current Time

An actor calls `fireAt()` to schedule a pure event. The pure event is a request to the scheduler to fire the actor sometime in the future. However, the actor may choose to call `fireAt()` with the time argument equal to the current time. In fact, the preferred method for domain-polymorphic source actors to get started is to have code like the following in their `initialize()` method:

```
Director director = getDirector();  
director.fireAt(this, director.getCurrentTime());
```

This will schedule a pure event on the event queue with microstep zero and depth equal to that of the calling actor.

An actor may also call `fireAt()` with the current time in its `fire()` method. This is a request to be refired later *in the current iteration*. This is managed by queueing a pure event with microstep one greater than the current microstep. In fact, this is only situation in which the microstep is incremented beyond zero.

15.1.6 Stopping Execution

Execution stops when one of these conditions become true:

- The current time reaches the *stop time*, set by calling the `setStopTime()` method of the DE director.
- The global event queue becomes empty.

Events at the stop time are processed before stopping the model execution. The execution ends by calling the `wrapup()` method of all actors.

It is also possible to explicitly invoke the `iterate()` method of the manager for some fixed number of iterations. Recall that an iteration processes all events with a given time stamp, so this will run the model through a specified number of discrete time steps.

15.2 Overview of The Software Architecture

The UML static structure diagram for the DE kernel package is shown in figure 15.4. For model builders, the important classes are `DEDirector`, `DEActor` and `DEIOPort`. At the heart of `DEDirector` is a global event queue that sorts events according to their time stamps and priorities.

The `DEDirector` uses an efficient implementation of the global event queue, a calendar queue data

structure [12]. The time complexity for this particular implementation is $O(1)$ in both enqueue and dequeue operations, in theory. This means that the time complexity for enqueue and dequeue operations is independent of the number of pending events in the global event queue. However, to realize this performance, it is necessary for the distribution of events to match certain assumptions. Our calendar queue implementation observes events as they are dequeued and adapts the structure of the queue according to their statistical properties. Nonetheless, the calendar queue structure will not prove optimal for all models. For extensibility, alternative implementations of the global event queue can be realized by implementing the `DEEventQueue` interface and specifying the event queue using the appropriate constructor for `DEDirector`.

The `DEEvent` class carries tokens through the event queue. It contains their time stamp, their microstep, and the depth of the destination actor, as well as a reference to the destination actor. It implements the `java.lang.Comparable` interface, meaning that any two instances of `DEEvent` can be compared. The private inner class `DECQEventQueue.DECQComparator`, which is provided to the calendar queue at the time of its construction, performs the requisite comparisons of events.

The `DEActor` class provides convenient methods to access time, since time is an essential part of a timed domain like DE. Nonetheless, actors in a DE model are not required to be derived from the `DEActor` class. Simply deriving from `TypedAtomicActor` gives you the same capability, but without the convenience. In the latter case, time is accessible through the director.

The `DEIOPort` class is used by actors that are specialized to the DE domain. It supports annotations that inform the scheduler about delays through the actor. It also provides two additional methods, overloaded versions of `broadcast()` and `send()`. The overloaded versions have a second argument for the time delay, allowing actors to send output data with a time delay (relative to current time).

Domain polymorphic actors, such as those described in the Actor Libraries chapter, have as ports instances of `TypedIOPort`, not `DEIOPort`, and therefore cannot produce events in the future directly by sending it through output ports. Note that tokens sent through `TypedIOPort` are treated as if they were sent through `DEIOPort` with the time delay argument equal to zero. Domain polymorphic actors can produce events in the future indirectly by using the `fireAt()` method of the director. By calling `fireAt()`, the actor requests a refiring in the future. The actor can then produce a delayed event during the refiring.

15.3 The DE Actor Library

The DE domain has a small library of actors in the `ptolemy.domains.de.lib` package, shown in figure 15.5. These actors are particularly characterized by implementing both the `TimedActor` and `SequenceActor` interfaces. These actors use the current model time, and in addition, assume they are dealing with sequences of discrete events. Some of them use domain-specific infrastructure, such as the convenience class `DEActor` and the base class `DETransformer`. The `DETransformer` class provides in input and output port that are instances of `DEIOPort`. The `Delay` and `Server` actors use facilities of these ports to influence the firing priorities. The `Merge` actor merges events sequences in chronological order.

15.4 Mutations

The DE director tolerates changes to the model during execution. The change should be queued using `requestChange()`. While invoking those changes, the method `invalidateSchedule()` is expected to be called, notifying the director that the topology it used to calculate the priorities of the actors is no

longer valid. This will result in the priorities being recalculated the next time `prefire()` is invoked.

An example of a mutation is shown in figures 15.6 and 15.7. Figure 15.7 defines a class that constructs a simple model in its constructor. The model consists of a clock connected to a recorder. The method `insertClock()` creates an anonymous inner class that extends `ChangeRequest`. Its `execute()` method disconnects the two existing actors, creates a new clock and a merge actor, and reconnects the actors as shown in figure 15.6.

When the `insertClock()` method is called, a change request is queue with the top-level composite actor, which delegates the request to the manager. The manager executes the request after the current iteration completes. Thus, the change will always be executed between non-equal time stamps, since an iteration consists of processing all events at the current time stamp.

Actors that are added in the change request are automatically initialized. Note, however, one sub-

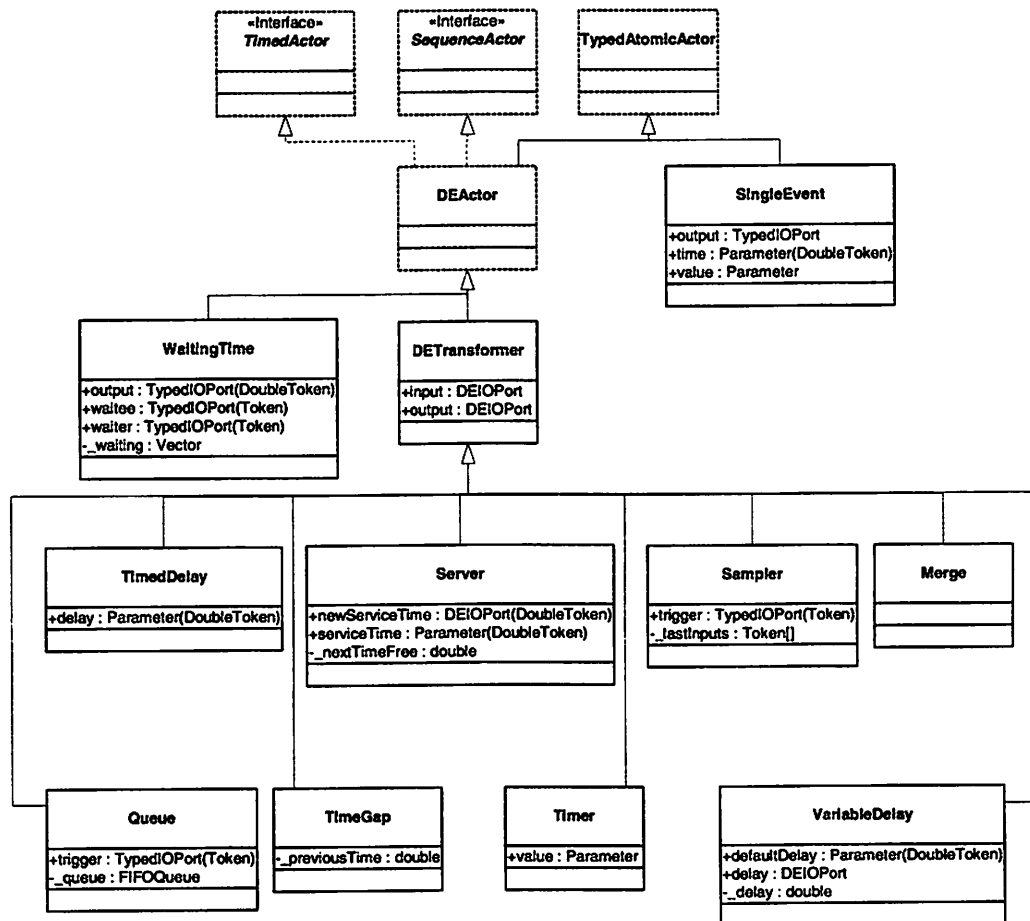

FIGURE 15.5. The library of DE-specific actors.

tlety. The next to last line of the insertClock() method is:

```
_rec.input.createReceivers();
```

This method call is necessary because the connections of the recorder actor have changed, but since the actor is not new, it will *not* be reinitialized. Recall that the preinitialize() and initialize() methods are guaranteed to be called only once, and one of the responsibilities of the preinitialize() method is to create the receivers in all the input ports of an actor. Thus, whenever connections to an input port change during a mutation, the mutation code itself must call createReceivers() to reconstruct the receivers. Note that this will result in the loss of any tokens that might already be queued in the preexisting receivers of the ports. It is because of this possible loss of data that the creation of receivers is not done automatically. The designer of the mutation should be aware of the possible loss of data.

There is one additional subtlety about mutations. If an actor produces events in the future via DEIOPort, then the destination actor will be fired even if it has been removed from the topology by the time the execution reaches that future time. This may not always be the expected behavior. The Delay actor in the DE library behaves this way, so if its destination is removed before processing delayed events, then it may be invoked at a time when it has no container. Most actors will tolerate this and will not cause problems. But some might have unexpected behavior. To prevent this behavior, the mutation that removes the actor should also call the disableActor() method of the director.

15.5 Writing DE Actors

It is very common in DE modeling to include custom-built actors. No pre-defined actor library seems to prove sufficient for all applications. For the most part, writing actors for the DE domain is no different than writing actors for any other domain. Some actors, however, need to exercise particular control over time stamps and actor priorities. Such actors use instances of DEIOPort rather than Type-dIOPort. The first section below gives general guidelines for writing DE actors and domain-polymorphic actors that work in DE. The second section explains in detail the priorities, and in particular, how to write actors that declare delays. The final section discusses actors that operate as a Java thread.

15.5.1 General Guidelines

The points to keep in mind are:

- When an actor fires, not all ports have tokens, and some ports may have more than one token. The

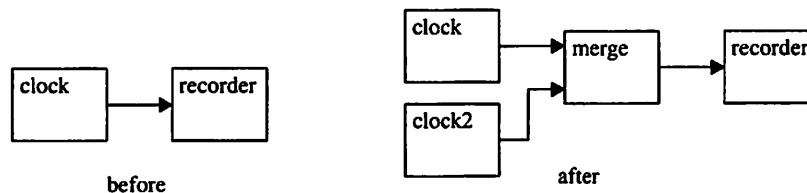

FIGURE 15.6. Topology before and after mutation for the example in figure 15.7.

time stamps of the events that contained these tokens are no longer explicitly available. The current model time is assumed to be the time stamp of the events.

- If the actor leaves unconsumed tokens on its input ports, then it will be iterated again before model

```

package ptolemy.domains.de.lib.test;

import ptolemy.kernel.util.*;
import ptolemy.kernel.*;
import ptolemy.actor.*;
import ptolemy.actor.lib.*;
import ptolemy.domains.de.kernel.*;
import ptolemy.domains.de.lib.*;

public class Mutate {

    public Manager manager;

    private Recorder _rec;
    private Clock _clock;
    private TypedCompositeActor _top;
    private DEDirector _director;

    public Mutate() throws IllegalArgumentException,
        NameDuplicationException {
        _top = new TypedCompositeActor();
        _top.setName("top");
        manager = new Manager();
        _director = new DEDirector();
        _top.setDirector(_director);
        _top.setManager(manager);

        _clock = new Clock(_top, "clock");
        _clock.values.setExpression("[1.0]");
        _clock.offsets.setExpression("[0.0]");
        _clock.period.setExpression("1.0");
        _rec = new Recorder(_top, "recorder");
        _top.connect(_clock.output, _rec.input);
    }

    public void insertClock() {
        // Create an anonymous inner class
        ChangeRequest change = new ChangeRequest(_top, "test2") {
            public void _execute() throws IllegalArgumentException,
                NameDuplicationException {
                _clock.output.unlinkAll();
                _rec.input.unlinkAll();
                Clock clock2 = new Clock(_top, "clock2");
                clock2.values.setExpression("[2.0]");
                clock2.offsets.setExpression("[0.5]");
                clock2.period.setExpression("2.0");
                Merge merge = new Merge(_top, "merge");
                _top.connect(_clock.output, merge.input);
                _top.connect(clock2.output, merge.input);
                _top.connect(merge.output, _rec.input);
                // Any pre-existing input port whose connections
                // are modified needs to have this method called.
                _rec.input.createReceivers();
                _director.invalidateSchedule();
            }
        };
        _top.requestChange(change);
    }
}

```

FIGURE 15.7. An example of a class that constructs a model and then mutates it.

time is advanced. This ensures that the current model time is in fact the time stamp of the input events. However, occasionally, an actor will want to leave unconsumed tokens on its input ports, and not be fired again until there is some other new event to be processed. To get this behavior, it should return *false* from `prefire()`. This indicates to the DE director that it does not wish to be iterated.

- If the actor returns *false* from `postfire()`, then the director will not fire that actor again. Events that are destined for that actor are discarded.
- When an actor produces an output token, the time stamp for the output event is taken to be the current model time. If the actor wishes to produce an event at a future model time, one way to accomplish this is to call the director's `fireAt()` method to schedule a future firing, and then to produce the token at that time. A second way to accomplish this is to use instances of `DEIOPort` and use the overloaded `send()` or `broadcast()` methods that take a time delay argument.
- The `DEIOPort` class (see figure 15.4) can produce events in the future, but there is an important subtlety with using these methods. Once an event has been produced, it cannot be retracted. In particular, even if the actor is deleted before model time reaches that of the future event, the event will be delivered to the destination. If you use `fireAt()` instead to generate delayed events, then if the actor is deleted (or returns *false* from `postfire()`) before the future event, then the future event will not be produced.
- By convention in Ptolemy II, actors update their state only in the `postfire()` method. In DE, the `fire()` method is only invoked once per iteration, so there is no particular reason to stick to this convention. Nonetheless, we recommend that you do in case your actor becomes useful in other domains. The simplest way to ensure this is follow the following pattern. For each state variable, such as a private variable named `_count`,

```
private int _count;
```

create a shadow variable

```
private int _countShadow;
```

Then write the methods as follows:

```
public void fire() {
    _countShadow = _count;
    ... perform some computation that may modify _countShadow ...
}
public boolean postfire() {
    _count = _countShadow;
    return super.postfire();
}
```

This ensures that the state is updated only in `postfire()`.

In a similar fashion, delayed outputs (produced by either mechanism) should be produced only in the `postfire()` method, since a delayed outputs are persistent state. Thus, `fireAt()` should be called in `postfire()` only, as should the overloaded `send()` and `broadcast()` of `DEIOPort`.

15.5.2 Examples

Simplified Delay Actor. An example of a domain-specific actor for DE is shown in figure 15.8. This actor delays input events by some amount specified by a parameter. The domain-specific features of the actor are shown in bold. They are:

- It uses **DEIOPort** rather than **TypedIOPort**.
- It has the statement:

```
input.delayTo(output);
```

This statement declares to the director that this actor implements a delay from input to output. The actor uses this to break the precedences when constructing the DAG to find priorities.

- It uses an overloaded **send()** method, which takes a delay argument, to produce the output. Notice that the output is produced in the **postfire()** method, since by convention in Ptolemy II, persistent state is not updated in the **fire()** method, but rather is updated in the **postfire()** method.

```
package ptolemy.domains.de.lib.test;

import ptolemy.actor.TypedAtomicActor;
import ptolemy.domains.de.kernel.DEIOPort;
import ptolemy.data.DoubleToken;
import ptolemy.data.Token;
import ptolemy.data.expr.Parameter;
import ptolemy.actor.TypedCompositeActor;
import ptolemy.kernel.util.IllegalActionException;
import ptolemy.kernel.util.NameDuplicationException;
import ptolemy.kernel.util.Workspace;

public class SimpleDelay extends TypedAtomicActor {

    public SimpleDelay(TypedCompositeActor container, String name)
        throws NameDuplicationException, IllegalActionException {
        super(container, name);
        input = new DEIOPort(this, "input", true, false);
        output = new DEIOPort(this, "output", false, true);
        delay = new Parameter(this, "delay", new DoubleToken(1.0));
        delay.setTypeEquals(DoubleToken.class);
        input.delayTo(output);
    }

    public Parameter delay;
    public DEIOPort input;
    public DEIOPort output;
    private Token _currentInput;

    public void fire() throws IllegalActionException {
        _currentInput = input.get(0);
    }

    public boolean postfire() throws IllegalActionException {
        output.send(0, _currentInput,
            ((DoubleToken)delay.getToken()).doubleValue());
        return super.postfire();
    }
}
```

FIGURE 15.8. A domain-specific actor in DE.

Server Actor. The Server actor in the DE library (see figure 15.5) uses a rich set of behavioral properties of the DE domain. A server is a process that takes some amount of time to serve “customers.” While it is serving a customer, other arriving customers have to wait. This actor can have a fixed service time (set via the parameter *serviceTime*, or a variable service time, provided via the input port *newServiceTime*). A typical use would be to supply random numbers to the *newServiceTime* port to generate random service times. These times can be provided at the same time as arriving customers to get an effect where each customer experiences a different, randomly selected service time.

The (compacted) code is shown in figure 15.9. This actor extends *DETransformer*, which has two public members, *input* and *output*, both instances of *DEIOPort*. The constructor makes use of the *delayTo()* method of these ports to indicate that the actor introduces delay between its inputs and its output.

The actor keeps track of the time at which it will next be free in the private variable *_nextTimeFree*. This is initialized to minus infinity to indicate that whenever the model begins executing, the server is free. The *prefire()* method determines whether the server is free by comparing this private variable against the current model time. If it is free, then this method returns true, indicating to the scheduler that it can proceed with firing the actor. If the server is not free, then the *prefire()* method checks to see whether there is a pending input, and if there is, requests a firing when the actor will become free. It then returns false, indicating to the scheduler that it does not wish to be fired at this time. Note that the *prefire()* method uses the methods *getCurrentTime()* and *fireAt()* of *DEActor*, which are simply convenient interfaces to methods of the same name in the director.

The *fire()* method is invoked only if the server is free. It first checks to see whether the *newServiceTime* port is connected to anything, and if it is, whether it has a token. If it does, the token is read and used to update the *serviceTime* parameter. No more than one token is read, even if there are more in the input port, in case one token is being provided per pending customer.

The *fire()* method then continues by reading an input token, if there is one, and updating *_nextTimeFree*. The input token that is read is stored temporarily in the private variable *_currentInput*. The *postfire()* method then produces this token on the output port, with an appropriate delay. This is done in the *postfire()* method rather than the *fire()* method in keeping with the policy in Ptolemy II that persistent state is not updated in the *fire()* method. Since the output is produced with a future time stamp, then it is persistent state.

Note that when the actor will not get input tokens that are available in the *fire()* method, it is essential that *prefire()* return false. Otherwise, the DE scheduler will keep firing the actor until the inputs are all consumed, which will never happen if the actor is not consuming inputs!

Like the *SimpleDelay* actor in figure 15.8, this one produces outputs with future time stamps, using the overloaded *send()* method of *DEIOPort* that takes a delay argument. There is a subtlety associated with this design. If the model mutates during execution, and the Server actor is deleted, it cannot retract events that it has already sent to the output. Those events will be seen by the destination actor, even if by that time neither the server nor the destination are in the topology! This could lead to some unexpected results, but hopefully, if the destination actor is no longer connected to anything, then it will not do much with the token.

15.5.3 Thread Actors

In some cases, it is useful to describe an actor as a thread that waits for input tokens on its input ports. The thread suspends while waiting for input tokens and is resumed when some or all of its input ports have input tokens. While this description is functionally equivalent to the standard description

```

package ptolemy.domains.de.lib;
import statements ...
public class Server extends DETransformer {

    public DEIOPort newServiceTime;
    public Parameter serviceTime;

    private Token _currentInput;
    private double _nextTimeFree = Double.NEGATIVE_INFINITY;

    public Server(TypedCompositeActor container, String name)
        throws NameDuplicationException, IllegalActionException {
        super(container, name);
        serviceTime = new Parameter(this, "serviceTime", new DoubleToken(1.0));
        serviceTime.setTypeEquals(BaseType.DOUBLE);
        newServiceTime = new DEIOPort(this, "newServiceTime", true, false);
        newServiceTime.setTypeEquals(BaseType.Double);
        output.setTypeAtLeast(input);
        input.delayTo(output);
        newServiceTime.delayTo(output);
    }

    ... attributeChanged(), clone() methods ...

    public void initialize() throws IllegalActionException {
        super.initialize();
        _nextTimeFree = Double.NEGATIVE_INFINITY;
    }

    public boolean prefire() throws IllegalActionException {
        DEDirector director = (DEDirector)getDirector(); DEDirector dir = (DEDirector)getDirector();

        if (director.getCurrentTime() >= _nextTimeFree) {
            return true;
        } else {
            // Schedule a firing if there is a pending token so it can be served.
            if (input.hasToken(0)) {
                director.fireAt(this, _nextTimeFree);
            }
            return false;
        }
    }

    public void fire() throws IllegalActionException {
        if (newServiceTime.getWidth() > 0 && newServiceTime.hasToken(0)) {
            DoubleToken time = (DoubleToken)(newServiceTime.get(0));
            serviceTime.setToken(time);
        }
        if (input.getWidth() > 0 && input.hasToken(0)) {
            _currentInput = input.get(0);
            double delay = ((DoubleToken)serviceTime.getToken()).doubleValue();
            _nextTimeFree = ((DEDirector)getDirector()).getCurrentTime() + delay;
        } else {
            _currentInput = null;
        }
    }

    public boolean postfire() throws IllegalActionException {
        if (_currentInput != null) {
            double delay = ((DoubleToken)serviceTime.getToken()).doubleValue();
            output.send(0, _currentInput, delay);
        }
        return super.postfire();
    }
}

```

FIGURE 15.9. Code for the Server actor. For more details, see the source code.

explained above, it leverages on the Java multi-threading infrastructure to save the state information.

Consider the code for the ABRecognizer actor shown in figure 15.10. The two code listings implement two actors with equivalent behavior. The left one implements it as a threaded actor, while the right one implements it as a standard actor. We will from now on refer to the left one as the threaded description and the right one as the standard description. In both description, the actor has two input ports, `inportA` and `inportB`, and one output port, `outport`. The behavior is as follows.

Produce an output event at `outport` as soon as events at `inportA` and `inportB` occurs in that particular order, and repeat this behavior.

Note that the standard description needs a state variable `state`, unlike the case in the threaded description. In general the threaded description encodes the state information in the position of the code, while the standard description encodes it explicitly using state variables. While it is true that the context switching overhead associated with multi-threading application reduces the performance, we argue that the simplicity and clarity of writing actors in the threaded fashion is well worth the cost in some applications.

The infrastructure for this feature is shown in figure 15.4. To write an actor in the threaded fashion, one simply derives from the `DEThreadActor` class and implements the `run()` method. In many cases, the content of the `run()` method is enclosed in the infinite `'while(true)'` loop since many useful threaded actors do not terminate.

The `waitForNewInputs()` method is overloaded and has two flavors, one that takes no arguments and another that takes an `IOPort` array as argument. The first suspends the thread until there is at least one input token in at least one of the input ports, while the second suspends until there is at least one input token in any one of the specified input ports, ignoring all other tokens.

In the current implementation, both versions of `waitForNewInputs()` clear all input ports before the thread suspends. This guarantees that when the thread resumes, all tokens available are new, in the sense that they were not available before the `waitForNewInput()` method call.

```

public class ABRecognizer extends DEThreadActor {
    StringToken msg = new StringToken("Seen AB");

    // the run method is invoked when the thread
    // is started.
    public void run() {
        while (true) {
            waitForNewInputs();
            if (inportA.hasToken(0)) {
                IOPort[] nextinport = {inportB};
                waitForNewInputs(nextinport);
                outport.broadcast(msg);
            }
        }
    }
}

public class ABRecognizer extends DEActor {
    StringToken msg = new StringToken("Seen AB");

    // We need an explicit state variable in
    // this case.
    int state = 0;

    public void fire() {
        switch (state) {
            case 0:
                if (inportA.hasToken(0)) {
                    state = 1;
                    break;
                }
            case 1:
                if (inportB.hasToken(0)) {
                    state = 0;
                    outport.broadcast(msg);
                }
        }
    }
}

```

FIGURE 15.10. Code listings for two style of writing the ABRecognizer actor.

The implementation also guarantees that between calls to the `waitForNewInputs()` method, the rest of the DE model is suspended. This is equivalent to saying that the section of code between calls to the `waitForNewInput()` method is a critical section. One immediate implication is that the result of the method calls that check the configuration of the model (e.g. `hasToken()` to check the receiver) will not be invalidated during execution in the critical section. It also means that this should not be viewed as a way to get parallel execution in DE. For that, consider the DDE domain.

It is important to note that the implementation serializes the execution of threads, meaning that at any given time there is only one thread running. When a threaded actor is running (i.e. executing inside its `run()` method), all other threaded actors and the director are suspended. It will keep running until a `waitForNewInputs()` statement is reached, where the flow of execution will be transferred back to the director. Note that the director thread executes all non-threaded actors. This serialization is needed because the DE domain has a notion of global time, which makes parallelism much more difficult to achieve.

The serialization is accomplished by the use of monitor in the `DEThreadActor` class. Basically, the `fire()` method of the `DEThreadActor` class suspends the calling thread (i.e. the director thread) until the threaded actor suspends itself (by calling `waitForNewInputs()`). One key point of this implementation is that the threaded actors appear just like an ordinary DE actor to the DE director. The `DEThreadActor` base class encapsulates the threaded execution and provides the regular interfaces to the DE director. Therefore the threaded description can be used whenever an ordinary actor can, which is everywhere.

The code shown in figure 15.11 implements the `run` method of a slightly more elaborate actor with the following behavior:

Emit an output O as soon as two inputs A and B have occurred. Reset this behavior each time the input R occurs.

Future work in this area may involve extending the infrastructure to support various concurrency constructs, such as preemption, parallel execution, etc. It might also be interesting to explore new concurrency semantics similar to the threaded DE, but without the ‘forced’ serialization.

15.6 Composing DE with Other Domains

One of the major concepts in Ptolemy II is modeling heterogeneous systems through the use of hierarchical heterogeneity. Actors on the same level of hierarchy obey the same set of semantics rules. Inside some of these actors may be another domain with a different model of computation. This mechanism is supported through the use of opaque composite actors. An example is shown in figure 15.12. The outermost domain is DE and it contains seven actors, two of them are opaque and composite. The opaque composite actors contain subsystems, which in this case are in the DE and CT domains.

15.6.1 DE inside Another Domain

The DE subsystem completes one iteration whenever the opaque composite actor is fired by the outer domain. One of the complications in mixing domains is in the synchronization of time. Denote the current time of the DE subsystem by t_{inner} and the current time of the outer domain by t_{outer} . An iteration of the DE subsystem is similar to an iteration of a top-level DE model, except that prior to the iteration tokens are transferred from the ports of the opaque composite actors into the ports of the contained DE subsystem, and after the end of the iteration, the director requesting a refire at the smallest time stamp in the event queue of the DE subsystem.

The first of these is done in the `transferInputs()` method of the DE director. This method is extended from its default implementation in the `Director` class. The implementation in the `DEDirector` class advances the current time of the DE subsystem to the current time of the outer domain, then calls `super.transferInputs()`. It is done in order to correctly associate tokens seen at the input ports of the opaque composite actor, if any, with events at the current time of the outer domain, t_{outer} and put these events into the global event queue. This mechanism is, in fact, how the DE subsystem synchronizes its current time, t_{inner} with the current time of the outer domain, t_{outer} (Recall that the DE director advances time by looking at the smallest time stamp in the event queue of the DE subsystem). Specifically, before the advancement of the current time of the DE subsystem t_{inner} is less than or equal to the t_{outer} and after the advancement t_{inner} is equal to the t_{outer} .

Requesting a refiring is done in the `postfire()` method of the DE director by calling the `fireAt()` method of the executive director. Its purpose is to ensure that events in the DE subsystem are processed

```

public void run() {
    try {
        while (true) {
            // In initial state..
            waitForNewInputs();
            if (R.hasToken(0)) {
                // Resetting..
                continue;
            }
            if (A.hasToken(0)) {
                // Seen A..
                IOPort[] ports = {B,R};
                waitForNewInputs(ports);
                if (!R.hasToken(0)) {
                    // Seen A then B..
                    O.broadcast(new DoubleToken(1.0));
                    IOPort[] ports2 = {R};
                    waitForNewInputs(ports2);
                } else {
                    // Resetting
                    continue;
                }
            } else if (B.hasToken(0)) {
                // Seen B..
                IOPort[] ports = {A,R};
                waitForNewInputs(ports);
                if (!R.hasToken(0)) {
                    // Seen B then A..
                    O.broadcast(new DoubleToken(1.0));
                    IOPort[] ports2 = {R};
                    waitForNewInputs(ports2);
                } else {
                    // Resetting
                    continue;
                }
            } // while (true)
        } catch (IllegalActionException e) {
            getManager().notifyListenersOfException(e);
        }
    }
}

```

FIGURE 15.11. The `run()` method of the ABRO actor.

on time with respect to the current time of the outer domain, t_{outer}

Note that if the DE subsystem is fired due to the outer domain processing a refire request, then there may not be any tokens in the input port of the opaque composite actor at the beginning of the DE subsystem iteration. In that case, no new events with time stamps equal to t_{outer} will be put into the global event queue. Interestingly, in this case, the time synchronization will still work because t_{inner} will be advanced to the smallest time stamp in the global event queue which, in turn, has to be equal t_{outer} because we always request a refire according to that time stamp.

15.6.2 Another Domain inside DE

Due to its nature, the opaque composite actor is opaque and therefore, as far as the DE Director is concerned, behaves exactly like a domain polymorphic actor. Recall that domain polymorphic actors are treated as functions with zero delay in computation time. To produce events in the future, domain polymorphic actors request a refire from the DE director and then produce the events when it is refired.

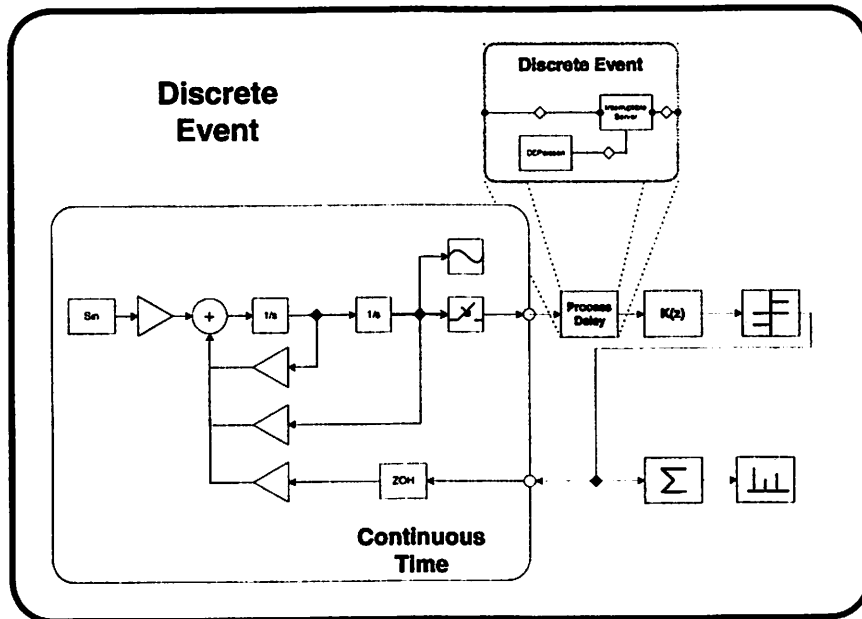
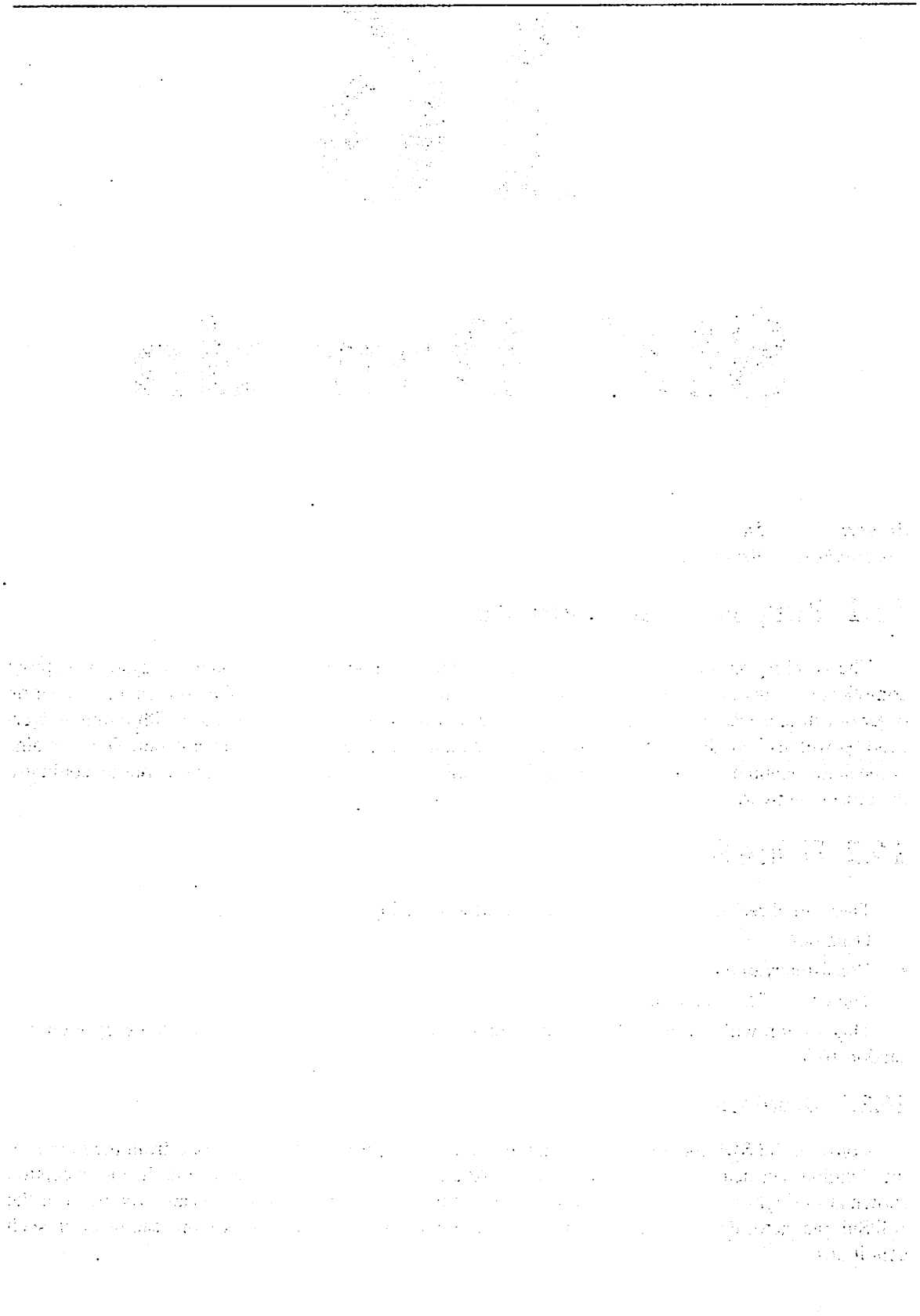

FIGURE 15.12. An example of heterogeneous and hierarchical composition. The CT subsystem and DE subsystem are inside an outermost DE system. This example is developed by Jie Liu [57].



16

SDF Domain

Author: Steve Neuendorffer

Contributor: Brian Vogel

16.1 Purpose of the Domain

The synchronous dataflow (SDF) domain is useful for modeling simple dataflow systems without complicated flow of control, such as signal processing systems. Under the SDF domain, the execution order of actors is statically determined prior to execution. This results in execution with minimal overhead, as well as bounded memory usage and a guarantee that deadlock will never occur. This domain is specialized, and may not always be suitable. Applications that require dynamic scheduling could use the process networks (PN) domain instead, for example.

16.2 Using SDF

There are three issues that must be addressed when using the SDF domain:

- Deadlock
- Consistency of data rates
- The value of the iterations parameter

This section will present a short description of these issues. For a more complete description, see section 16.3.

16.2.1 Deadlock

Consider the SDF model shown in figure 16.1. This actor has a feedback loop from the output of the AddSubtract actor back to its own input. Attempting to run the model results in the exception shown at the right in the figure. The director is unable to schedule the model because the input of the AddSubtract actor depends on data from its own output. In general, feedback loops can result in such conditions.

The fix for such deadlock conditions is to use the `SampleDelay` actor, shown highlighted in figure 16.2. This actor injects into the feedback loop an initial token, the value of which is given by the *initialOutputs* parameter of the actor. In the figure, this parameter has the value `{0}`. This is an array with a single token, an integer with value 0. A double delay with initial values 0 and 1 can be specified using a two element array, such as `{0, 1}`.

It is important to note that it is occasionally necessary to add a delay that is not in a feedback loop to match the delay of an in input with the delay around a feedback loop. It can sometimes be tricky to see exactly where such delays should be placed without fully considering the flow of the initial tokens described above.

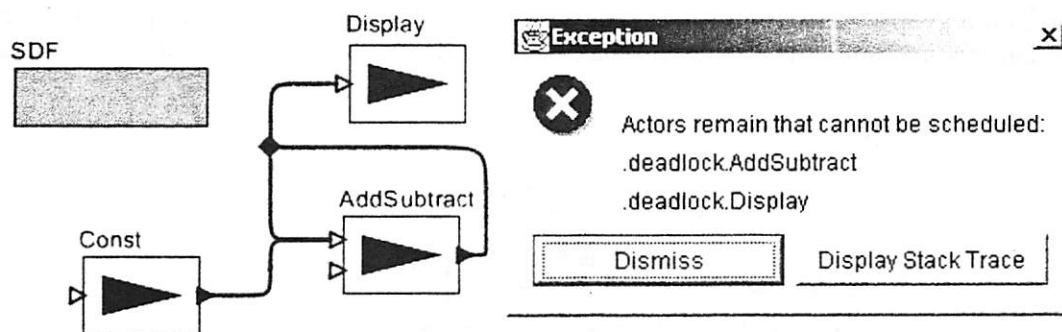

FIGURE 16.1. An SDF model that deadlocks.

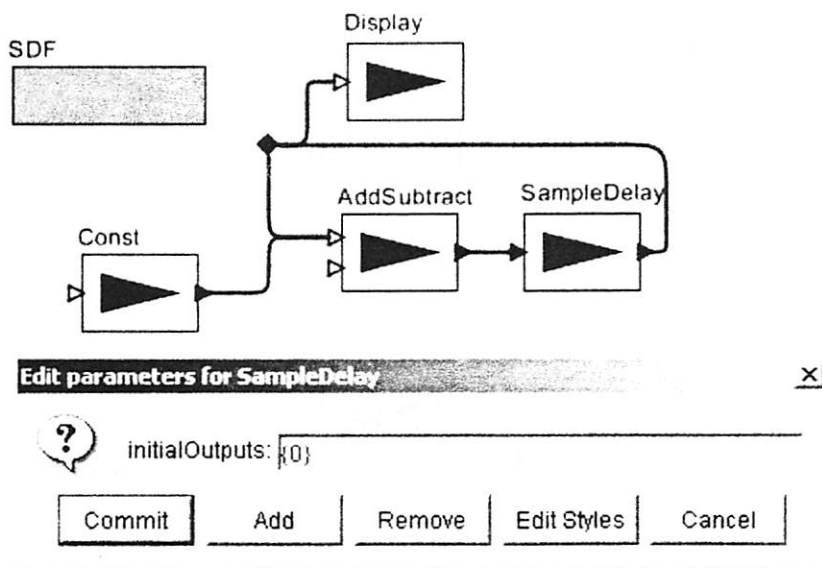

FIGURE 16.2. The model of figure 16.1 corrected with an instance of `SampleDelay` in the feedback loop.

16.2.2 Consistency of data rates

Consider the SDF model shown in figure 16.3. The model is attempting to plot a sinewave and its downsampled counterpart. However, there is an error because the number of tokens on each channel of the input port of the plotter can never be made the same. The DownSample actor declares that it consumes 2 tokens using the *tokenConsumptionRate* parameter of its input port. Its output port similarly declares that it produces only one token, so there will only be half as many tokens being plotted from the DownSample actor as from the Sinewave.

The fixed model is shown in figure 16.4, which uses two separate plotters. When the model is executed, the plotter on the bottom will fire twice as often as the plotter on the top, since must consume twice as many tokens. Notice that the problem appears because one of the actors (in this case, the DownSample actor) produces or consumes more than one token on one of its ports. One easy way to ensure rate consistency is to use actors that only produce and consume one token at a time. This special case is known as *homogeneous* SDF. Note that actors like the Sequence plotter which do not specify rate parameters are assumed to be homogeneous. For more specific information about the rate param-

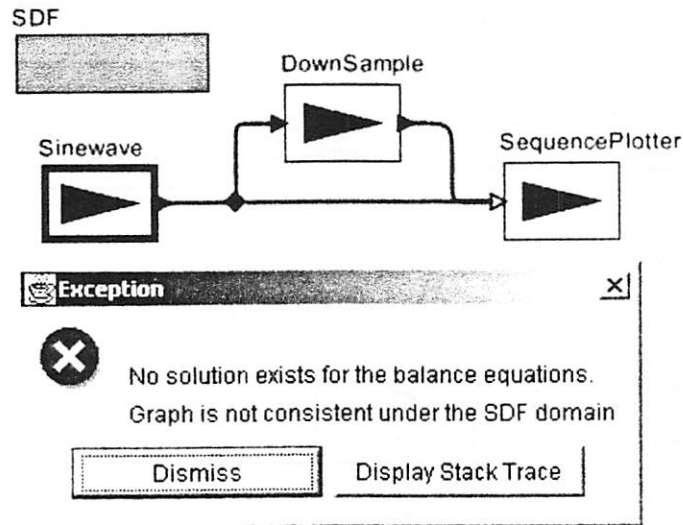

FIGURE 16.3. An SDF model with inconsistent rates.

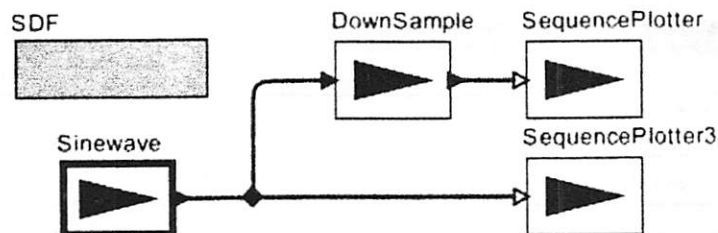

FIGURE 16.4. Figure 16.3 modified to have consistent rates.

ters and how they are used for scheduling, see section 16.3.1.

16.2.3 How many iterations?

One final issue when using the SDF domain concerns the value of the *iterations* parameter of the SDF director. In homogeneous models one token is usually produced for every iteration. However, when token rates other than one are used, more than one interesting output value may be created for each iteration. For example, consider figure 16.5 which contains a model that plots the Fast Fourier Transform of the input signal. The important thing to realize about this model is that the FFT actor declares that it consumes 256 tokens from its input port and produces 256 tokens from its output port, corresponding to an order 8 FFT. This means that only one iteration is necessary to produce all 256 values of the FFT.

Contrast this with the model in figure 16.6. This model plots the individual values of the signal. Here 256 iterations are necessary to see the entire input signal, since only one output value is plotted in each iteration.

16.3 Properties of the SDF domain

SDF is an untimed model of computation. All actors under SDF consume input tokens, perform their computation and produce outputs in one atomic operation. If an SDF model is embedded within a timed model, then the SDF model will behave as a zero-delay actor.

In addition, SDF is a statically scheduled domain. The firing of a composite actor corresponds to a

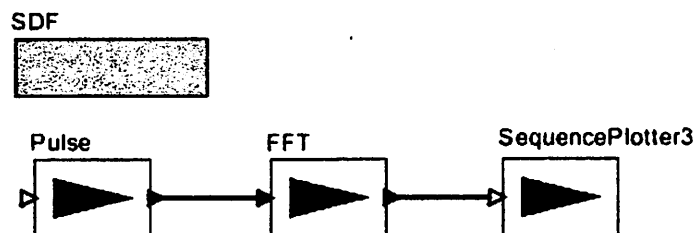

FIGURE 16.5. A model that plots the Fast Fourier Transform of a signal. Only one iteration must be executed to plot all 256 values of the FFT, since the FFT actor produces and consumes 256 tokens each firing.



FIGURE 16.6. A model that plots the values of a signal. 256 iterations must be executed to plot the entire signal.

single iteration of the contained(16.3.1) model. An SDF iteration consists of one execution of the pre-calculated SDF schedule. The schedule is calculated so that the number of tokens on each relation is the same at the end of an iteration as at the beginning. Thus, an infinite number of iterations can be executed, without deadlock or infinite accumulation of tokens on each relation.

Execution in SDF is extremely efficient because of the scheduled execution. However, in order to execute so efficiently, some extra information must be given to the scheduler. Most importantly, the data rates on each port must be declared prior to execution. The data rate represents the number of tokens produced or consumed on a port during every firing¹. In addition, explicit data delays must be added to feedback loops to prevent deadlock. At the beginning of execution, and any time these data rates change, the schedule must be recomputed. If this happens often, then the advantages of scheduled execution can quickly be lost.

16.3.1 Scheduling

The first step in constructing the schedule is to solve the *balance equations* [53]. These equations determine the number of times each actor will fire during an iteration. For example, consider the model in figure 16.7. This model implies the following system of equations, where *ProductionRate* and *ConsumptionRate* are declared properties of each port, and *Firings* is a property of each actor that will be solved for:

$$Firings(A) \times ProductionRate(A1) = Firings(B) \times ConsumptionRate(B1)$$

$$Firings(A) \times ProductionRate(A2) = Firings(C) \times ConsumptionRate(C1)$$

$$Firings(C) \times ProductionRate(C2) = Firings(B) \times ConsumptionRate(B2)$$

These equations express constraints that the number of tokens created on a relation during an iteration is equal to the number of tokens consumed. These equations usually have an infinite number of linearly dependent solutions, and the least positive integer solution for *Firings* is chosen as the *firing vector*, or the repetitions vector.

The second step in constructing an SDF schedule is dataflow analysis. Dataflow analysis orders the firing of actors, based on the relations between them. Since each relation represents the flow of data, the actor producing data must fire before the consuming actor. Converting these data dependencies to a sequential list of properly scheduled actors is equivalent to topologically sorting the SDF graph, if the graph is acyclic². Dataflow graphs with cycles cause somewhat of a problem, since such

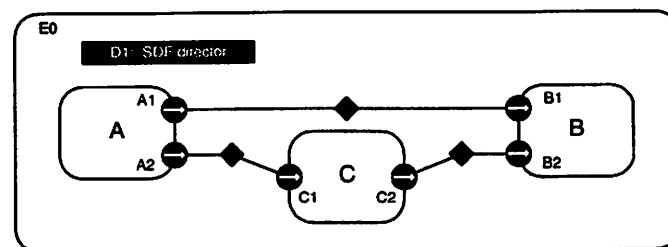

FIGURE 16.7. An example SDF model.

1. This is known as *multirate* SDF, where arbitrary rates are allowed. Not to be confused with *homogeneous* SDF, where the data rates are fixed to be one.

graphs cannot be topologically sorted. In order to determine which actor of the loop to fire first, a *data delay* must be explicitly inserted somewhere in the cycle. This delay is represented by an initial token created by one of the output ports in the cycle during initialization of the model. The presence of the delay allows the scheduler to break the dependency cycle and determine which actor in the cycle to fire first. In Ptolemy II, the initial token (or tokens) can be sent from any port, as long as the port declares an *initProduction* property. However, because this is such a common operation in SDF, the Delay actor (see section 16.5) is provided that can be inserted in a feedback loop to break the cycle. Cyclic graphs not properly annotated with delays cannot be executed under SDF. An example of a cyclic graph properly annotated with a delay is shown in figure 16.8.

In some cases, a non-zero solution to the balance equations does not exist. Such models are said to be *inconsistent*, and cannot be executed under SDF. Inconsistent graphs inevitably result in either deadlock or unbounded memory usage for any schedule. As such, inconsistent graphs are usually bugs in the design of a model. However, inconsistent graphs can still be executed using the PN domain, if the behavior is truly necessary. Examples of consistent and inconsistent graphs are shown in figure 16.9.

16.3.2 Hierarchical Scheduling

So far, we have assumed that the SDF graph is not hierarchical. The simplest way to schedule a hierarchical SDF model is flatten the model to remove the hierarchy, and then schedule the model as usual. This technique allows the most efficient schedule to be constructed for a model, and avoids certain composability problems when creating hierarchical models. In Ptolemy II, a model created using a transparent composite actor to define the hierarchy is scheduled in exactly this way.

Ptolemy II also supports a stronger version of hierarchy, in the form of opaque composite actors. In this case, the hierarchical actor appears to be no different from the outside than an atomic actor with no

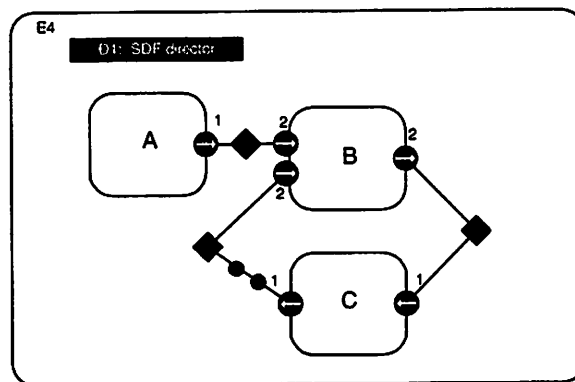

FIGURE 16.8. A consistent cyclic graph, properly annotated with delays. A one token delay is represented by a black circle. E3 is responsible for setting the *tokenInitProduction* parameter on its output port, and creating the two tokens during initialization. This graph can be executed using the schedule E1, E1, E2, E3, E3.

- Note that the topological sort does not correspond to a unique total ordering over the actors. Furthermore, especially in multirate models it may be possible to interleave the firings of actors that fire more than once. This can result in many possible schedules that represent different performance trade-offs. We anticipate that future schedulers will be implemented to take advantage of these trade-offs. For more information about these trade-offs, see [47].

hierarchy. The SDF domain does not have any information about the contained model, other than the rate parameters that may be specified on the ports of the composite actor. The SDF domain is designed so that it automatically sets the rates of external ports when the schedule is computed. Most other domains are designed (conveniently enough) so that their models are compatible with default rate properties assumed by the SDF domain. For a complete description of these defaults, see the description of the SDFScheduler class in section 16.4.2.

16.4 Software Architecture

The SDF kernel package implements the SDF model of computation. The structure of the classes in this package is shown in figure 16.10.

16.4.1 SDF Director

The SDFDirector class extends the StaticSchedulingDirector class. When an SDF director is created, it is automatically associated with an instance of the default scheduler class, SDFScheduler. This scheduler is intended to be relatively fast, but not designed to optimize for any particular performance goal. The SDF director does not currently restrict the schedulers that may be used with it. For more information about SDF schedulers, see section 16.4.2.

The director has a parameter, *iterations*, which determines a limit on the number of times the director wishes to be fired¹. After the director has been fired the given number of times, it will always return false in its postfire() method, indicating that it does not wish to be fired again. The *iterations* parameter must contain a non-negative integer value. The default value is an IntToken with value 0, indicating that there is no preset limit for the number of times the director will fire. Users will likely

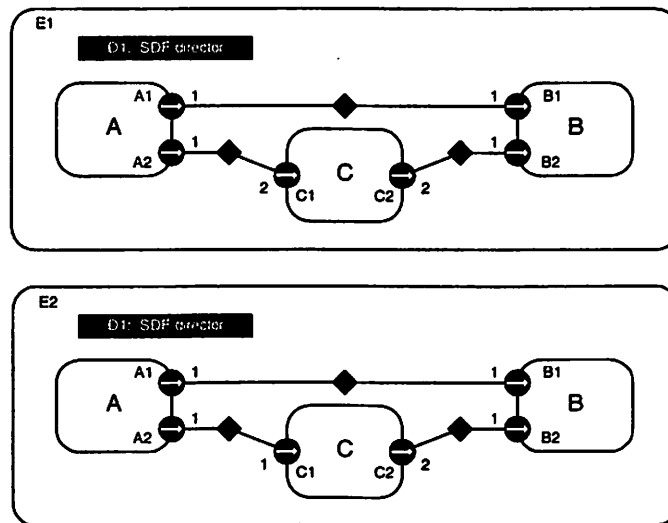

FIGURE 16.9. Two models, with each port annotated with the appropriate rate properties. The model on the top is consistent, and can be executed using the schedule A, A, C, B, B. The model on the bottom is inconsistent because tokens will accumulate between ports C2 and B2.

1. This parameter acts similarly to the Time-to-Stop parameter in Ptolemy Classic.

specify a non-zero value in the director of the toplevel composite actor as the number of toplevel iterations of the model.

The SDF director also has a *vectorizationFactor* parameter that can be used to request vectorized execution of a model. This parameter suggests that the director modify the schedule so that instead of firing each actor only once, it is fired *vectorizationFactor* times using the vectorized iterate method. The specified factor serves only as a suggestion, and the director is free to ignore it or to use a different factor. The *vectorizationFactor* parameter must contain a positive integer value. The default value is an *IntToken* with value one, indicating that no vectorization should be done. Note that vectorizing the execution of a model is not necessarily possible if the model contains feedback cycles. At the very least, it is likely that the data delay specified for any cycle must be increased (possibly changing the meaning of the model).

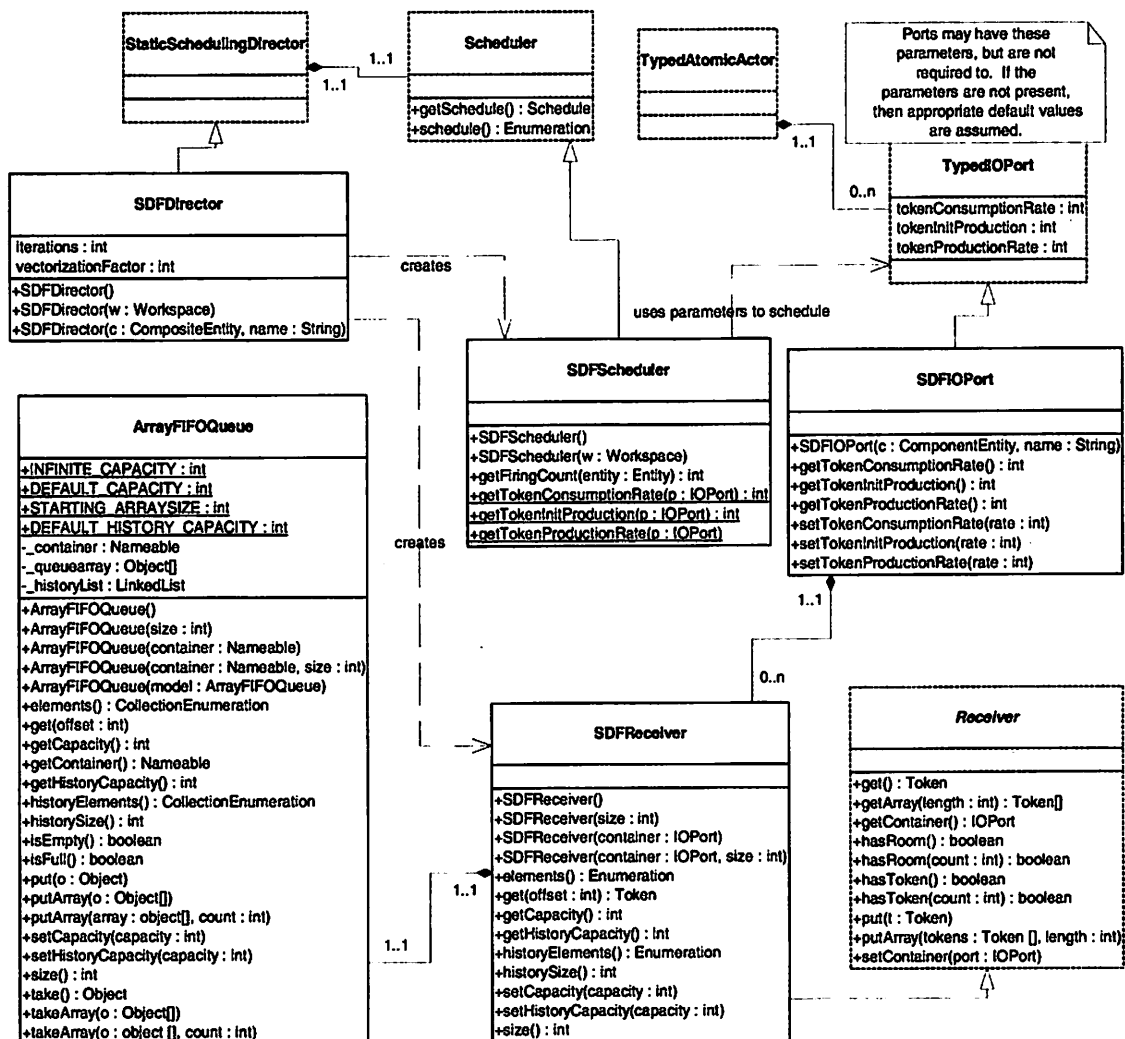

FIGURE 16.10. The static structure of the SDF kernel classes.

The `newReceiver()` method in SDF directors is overloaded to return instances of the `SDFReceiver` class. This receiver contains optimized method for reading and writing blocks of tokens. For more information about SDF receivers, see section 16.4.3.

16.4.2 SDF Scheduler

The basic `SDFScheduler` derives directly from the `Scheduler` class. This scheduler provides unlooped, sequential schedules suitable for use on a single processor. No attempt is made to optimize the schedule by minimizing data buffer sizes, minimizing the size of the schedule, or detecting parallelism to allow execution on multiple processors. We anticipate that more elaborate schedulers capable of these optimizations will be added in the future.

The scheduling algorithm is based on the simple multirate algorithm in [53]. Currently, only single processor schedules are supported. The multirate scheduling algorithm relies on the actors in the system to declare the data rates of each port. The data rates of ports are specified using three parameters on each port named *tokenConsumptionRate*, *tokenProductionRate*, and *tokenInitProduction*. The production parameters are valid only for output ports, while the consumption parameter is valid only for input ports. If a parameter exists that is not valid for a given port, then the value of the parameter must be zero, or the scheduler will throw an exception. If a valid parameter is not specified when the scheduler runs, then default values of the parameters will be assumed, however the parameters are not then created¹.

After scheduling, the SDF scheduler will set the rate parameters on any external ports of the composite actor. This allows a containing actor, which may represent an SDF model, to properly schedule the contained model, as long as the contained model is scheduled first. To ensure this, the SDF director forces the creation of the schedule after initializing all the actors in the model. This mechanism is illustrated in the sequence diagram in figure 16.11.

Disconnected graphs. SDF graphs should generally be connected. If an SDF graph is not connected, then there is some concurrency between the disconnected parts that is not captured by the SDF rate parameters. In such cases, another model of computation (such as process networks) should be used to explicitly specify the concurrency. As such, the current SDF scheduler disallows disconnected graphs, and will throw an exception if you attempt to schedule such a graph. However, sometimes it is useful to avoid introducing another model of computation, so it is possible that a future scheduler will allow disconnected graphs with a default notion of concurrency.

Multiports. Notice that it is impossible to set a rate parameter on individual channels of a port. This is intentional, and all the channels of an actor are assumed to have the same rate. For example, when the `AddSubtract` actor fires under SDF, it will consume exactly one token from each channel of its input *plus* port, consume one token from each channel of its *minus* port, and produce one token the single channel of its *output* port. Notice that although the domain-polymorphic adder is written to be more general than this (it will consume *up to* one token on each channel of the input port), the SDF scheduler will ensure that there is always at least one token on each input port before the actor fires.

Dangling ports. All channels of a port are required to be connected to a remote port under the SDF domain. A regular port that is not connected will always result in an exception being thrown by the

1. The assumed values correspond to a homogeneous actor with no data delay. Input ports are assumed to have a consumption rate of one, output ports are assumed to have a production rate of one, and no tokens are produced during initialization.

scheduler. However, the SDF scheduler detects multiports that are not connected to anything (and thus have zero width). Such ports are interpreted to have no channels, and will be ignored by the SDF scheduler.

16.4.3 SDF ports and receivers

Unlike most domains, multirate SDF systems tend to produce and consume large blocks of tokens during each firing. Since there can be significant overhead in data transport for these large blocks, SDF receivers are optimized for sending and receiving a block of tokens *en masse*.

The SDFReceiver class implements the Receiver interface. Instead of using the FIFOQueue class to store data, which is based on a linked list structure, SDF receivers use the ArrayFIFOQueue class, which is based on a circular buffer. This choice is much more appropriate for SDF, since the size of the buffer is bounded, and can be determined statically¹.

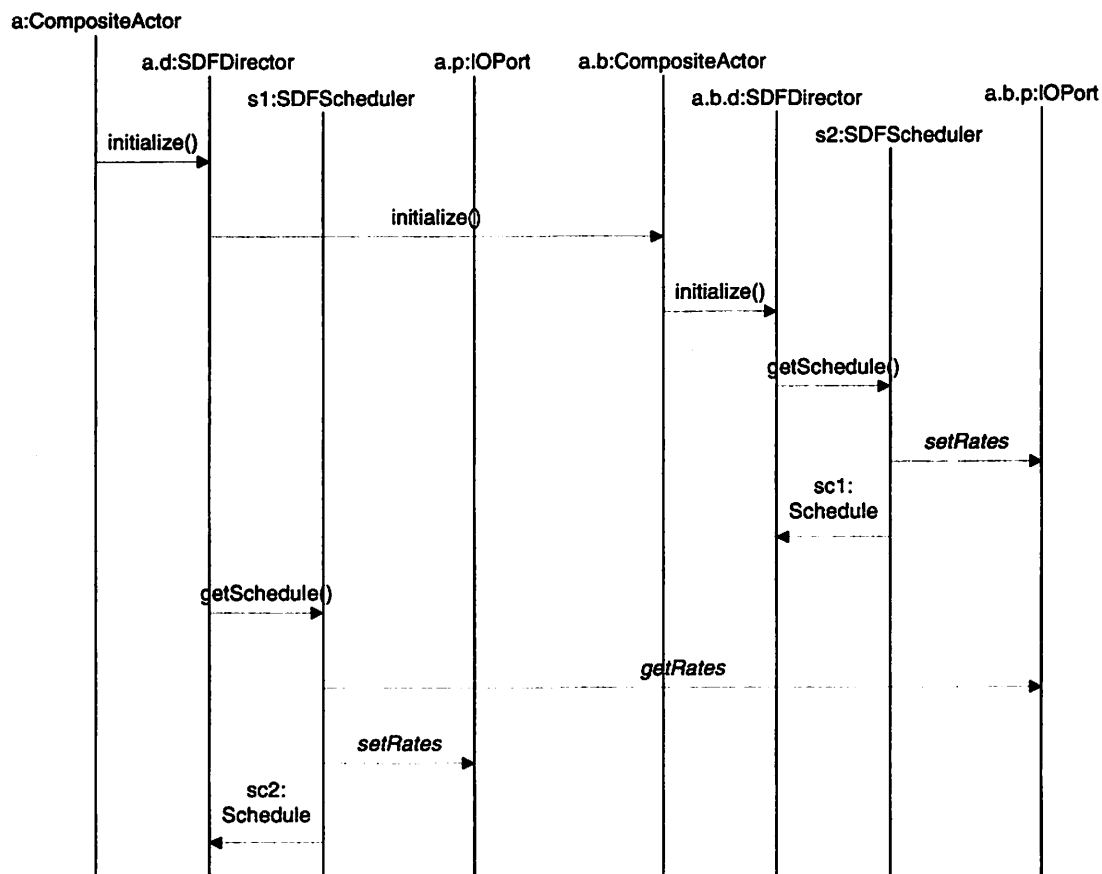

FIGURE 16.11. The sequence of method calls during scheduling of a hierarchical model.

1. Although the buffer sizes can be statically determined, the current mechanism for creating receivers does not easily support it. The SDF domain currently relies on the buffer expanding algorithm that the ArrayFIFOQueue uses to implement circular buffers of unbounded size. Although there is some overhead during the first iteration, the overhead is minimal during subsequent iterations (since the buffer is guaranteed never to grow larger).

The SDFIOPort class extends the TypedIOPort class. It exists mainly for convenience when creating actors in the SDF domain. It provides convenience methods for setting and accessing the rate parameters used by the SDF scheduler.

16.4.4 ArrayFIFOQueue

The ArrayFIFOQueue class implements a first in, first out (FIFO) queue by means of a circular array buffer¹. Functionally it is very similar to the FIFOQueue class, although with different enqueue and dequeue performance. It provides a token history and an adjustable, possibly unspecified, bound on the number token it contains.

If the bound on the size is specified, then the array is exactly the size of the bound. In other words, the queue is full when the array becomes full. However, if the bound is unspecified, then the circular buffer is given a small starting size and allowed to grow. Whenever the circular buffer fills up, it is copied into a new buffer that is twice the original size.

16.5 Actors

Most domain-polymorphic actors can be used under the SDF domain. However, actors that depend on a notion of time may not work as expected. For example, in the case of a TimedPlotter actor, all data will be plotted at time zero when used in SDF. In general, domain-polymorphic actors (such as AddSubtract) are written to consume at most one token from each input port and produce exactly one token on each output port during each firing. Under SDF, such an actor will be assumed to have a rate of one on each port, and the actor will consume exactly one token from each input port during each firing. There is one actor that is normally only used in SDF: the Delay actor. The delay actor is provided to make it simple to build models with feedback, by automatically handling the *tokenInitProduction* parameter and providing a way to specify the tokens that are created.

Delay

Ports: *input* (Token), *output* (Token).
Parameters: *initialOutputs* (ArrayToken).

During initialization, create a token on the output for each token in the *initialOutputs* array. During each firing, consume one token on the input and produce the same token on the output.

1. Adding an array of objects to an ArrayFIFOQueue is implemented using the `java.lang.system.arraycopy` method. This method is capable of safely removing certain checks required by the Java language. On most Java implementations, this is significantly faster than a hand coded loop for large arrays. However, depending on the Java implementation it could actually be slower for small arrays. The cost is usually negligible, but can be avoided when the size of the array is small and known when the actor is written.

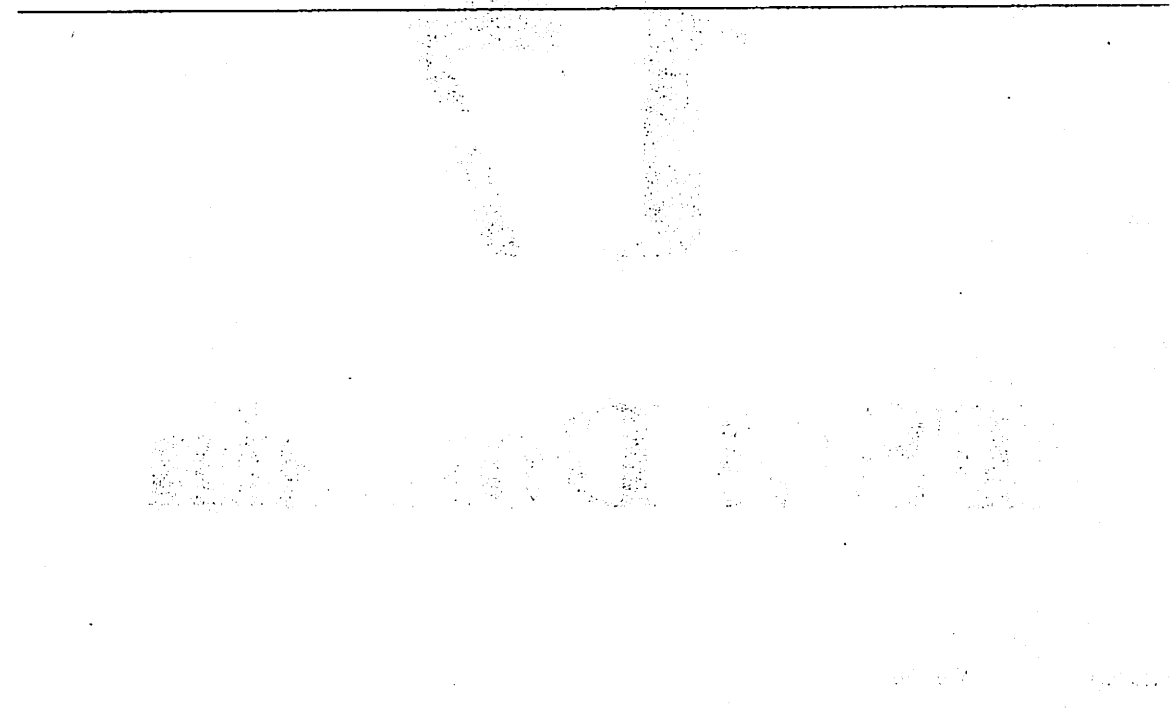

Section 101

The first part of the document discusses the general principles of the SDF domain. It covers the basic concepts and the scope of the domain. The text is very faint and difficult to read, but it appears to be a standard introductory section.

The second part of the document discusses the specific details of the SDF domain. It covers the various components and the relationships between them. The text is very faint and difficult to read, but it appears to be a detailed technical description.

The third part of the document discusses the practical applications of the SDF domain. It covers the various uses and the benefits of the domain. The text is very faint and difficult to read, but it appears to be a practical guide.

The fourth part of the document discusses the future of the SDF domain. It covers the various trends and the challenges of the domain. The text is very faint and difficult to read, but it appears to be a forward-looking analysis.

17

FSM Domain

Author: *Xiaojun Liu*

17.1 Introduction

Finite state machines (FSMs) have been used extensively in designing sequential control logic. There are two major reasons behind their use. First, FSMs are a very intuitive way to capture control logic and make it easier to communicate a design. Second, FSMs have been the subject of a long history of research work. Many formal analysis and verification methods have been developed for them.

In their simple flat form, FSM models have a key weakness: the number of states in an FSM model can get quite large even for a moderately complex system. Such models quickly become chaotic and incomprehensible when one tries to model a system having many concurrent activities. The problem can be solved by introducing hierarchical organization into FSM models and using them in combination with concurrency models. David Harel first used this approach when he introduced the *Statecharts* formalism [34].

The Statecharts formalism extends the conventional FSM model in three aspects: hierarchical decomposition of states, concurrent composition of FSMs in a synchronous-reactive fashion, and a broadcast communication mechanism between concurrent components. While how these extensions fit together was not completely specified in [34], Harel's work stimulated a lot of interest in the approach. Consequently, there is a proliferation of variants of the Statecharts formalism [7], each proposing a different way to make the extensions fit into a monolithic model. Unfortunately, in all these variants FSM is combined with a particular concurrency model. The applicability of the resulting models is often limited.

Based on the Ptolemy philosophy of hierarchical composition of heterogeneous models of computation, the **charts*¹ formalism [31] allows embedding hierarchical FSMs within a variety of concurrency models. If tight synchronization is possible and desirable, then FSMs can be composed by the

1. Pronounced "starcharts." The star represents a wildcard that can be interpreted as matching multiple concurrency models.

synchronous-reactive model. If the system has a global notion of time and components communicate by time-stamped events, then FSMs can be composed by the discrete-event model. The rest of this chapter focuses on how the FSM domain in Ptolemy II supports the *charts formalism.

17.2 Building FSMs in Vergil

An FSM model is contained by an instance of FSMActor. The FSM model reacts to inputs to the FSM actor by making state transitions. Actions such as sending tokens to the output ports of the FSM actor can be associated with state transitions. In this section, we show how to construct and run a model with an FSM actor in Vergil.

17.2.1 Alternate Mark Inversion Coder

Alternate Mark Inversion (AMI) is a simple digital transmission technique that encodes a bit stream on a signal line as shown below:

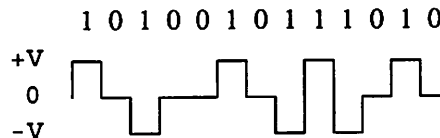

The 0 bits are transmitted with voltage zero. The 1 bits are transmitted alternately with positive and negative voltages. On average, the resulting waveform will have no DC component.

We can model an AMI coder with a two-state FSM shown in figure 17.2. To construct a Ptolemy II model containing this coder, follow these steps:

1. Start Vergil, open a graph editor by selecting File -> New -> Graph Editor.
2. From utilities in the palette on the left, drag an FSM actor to the graph. Rename the FSM actor AMICoder.
3. Right click on AMICoder, select Configure Ports. Add an input port with name *in* and an output port with name *out* to AMICoder.
4. Right click on AMICoder, select Look Inside. This will open an FSM editor for AMICoder. Note that the ports of AMICoder are placed at the upper left corner of the graph panel.
5. From the palette on the left, drag a state to the graph, rename it Positive. Drag another state to the graph, rename it Negative.
6. Control-drag from the Positive state to the Negative state to create a transition.
7. Double click on the transition. This will bring up the dialog box shown in figure 17.1 for editing the parameters of the transition.
8. Set guardExpression to `in == 1`, and outputActions to `out = 1`.
9. Create a transition from the Positive state back to itself with guard expression `in == 0` and output action `out = 0`.
10. Create a transition from the Negative state back to itself with guard expression `in == 0` and output action `out = 0`.

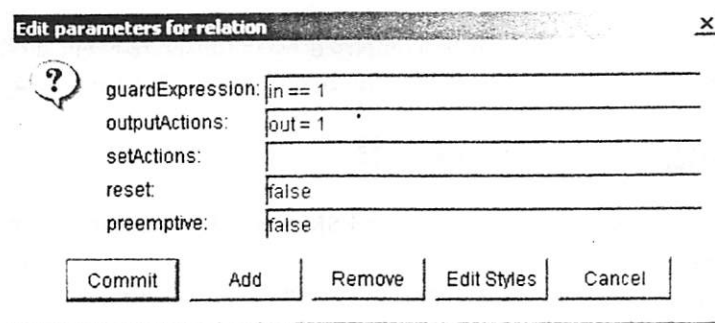

FIGURE 17.1. The dialog box for editing parameters of a transition.

11. Create a transition from the Negative state to the Positive state with guard expression `in == 1` and output action `out = -1`.
12. Right click on the background of the graph panel. Select Edit Parameters from the context menu. This will bring up the dialog box for editing parameters of AMICoder. Set `initialStateName` to Positive.
13. The construction of AMICoder is complete. It will look like what is shown in figure 17.2.
14. Return to the graph editor opened in step 1.
15. Drag a Pulse actor (from actor library, sources), a SequencePlotter (from actor library, sinks), and an SDF director (from director library) to the graph.
16. Connect the actors as shown in figure 17.3.
17. Edit parameters of the Pulse actor: set indexes to `{0, 1, 2, 3, 4, 5}`; set values to `{0, 1, 1, 1, 0, 1}`.

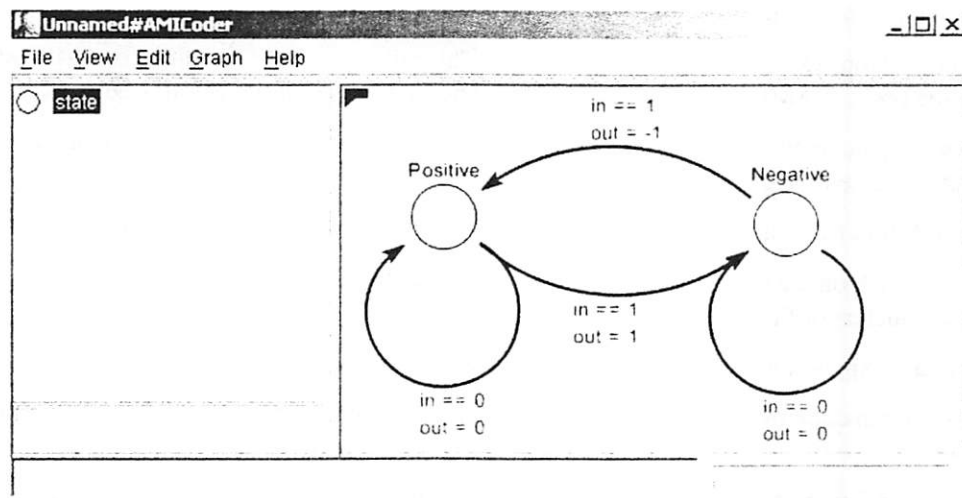

FIGURE 17.2. Vergil FSM editor showing the AMICoder.

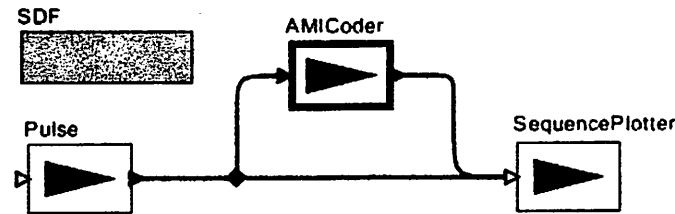

FIGURE 17.3. An SDF model with the AMICoder.

18. The model construction is complete.
19. Select View -> Run Window from the menu. Set director iterations to 6 and execute the model. For a better display of the result, open the set plot format dialog box, unselect connect and use various marks.

17.3 The Implementation of FSMActor

The FSMActor-related classes in the FSM kernel package are shown in figure 17.4.

The FSMActor class extends the CompositeEntity class and implements the TypedActor interface. An FSM actor contains states and transitions. The State class is a subclass of ComponentEntity. A State has two ports: incomingPort, which links to incoming transitions to the state, and outgoingPort, which links to transitions going out from the state. The Transition class is a subclass of ComponentRelation. A transition links to exactly two ports: the outgoing port of its source state, and the incoming port of its destination state.

17.3.1 Guard Expressions

The guard of a transition is specified by its *guardExpression* string attribute. Guard expressions are parsed and evaluated using the Ptolemy II expression language (see the Data chapter for details). Guard expressions should evaluate to a boolean value. A transition is enabled if its guard expression evaluates to true. Parameters of the FSM actor and input variables (defined below) can be used in guard expressions.

Input variables represent the status and input value for each input port of the FSM actor. If the input port is a single port, two variables are used: a status variable named *portName_isPresent*, and a value variable named *portName*. If the input port is a multiport of width n , $2n$ variables are used, two for each channel: a status variable named *portName_channelIndex_isPresent*, and a value variable named *portName_channelIndex*. The status variables will have boolean value true if there is a token at the corresponding input, or false otherwise. The value variables have the same type as the corresponding input, and contain the token received from the input, or null if there is no token. All input variables are contained by the FSM actor.

In the following examples (and the examples in the next section), we assume that the FSM actor has two input ports: a single port *in1* and a multiport *in2* of width 2; an output port *out* that is a multiport of width 2; and a parameter *param*.

- Guard expression: $in2_0 + in2_1 > 10$. If the inputs from the two channels of port *in2* have a total greater than 10, the transition is enabled. Note that if one or both channels of port *in2* do not

have a token when this expression is evaluated, an exception will be thrown.

- Guard expression: `in1_isPresent && in1 > param`. If there is input from port `in1` and the value of the input is greater than `param`, the transition is enabled.

17.3.2 Actions

A transition can have a set of actions that produce output tokens or set parameters of the FSM actor. To make FSM actors domain polymorphic (see section 3.5), especially for them to be operational

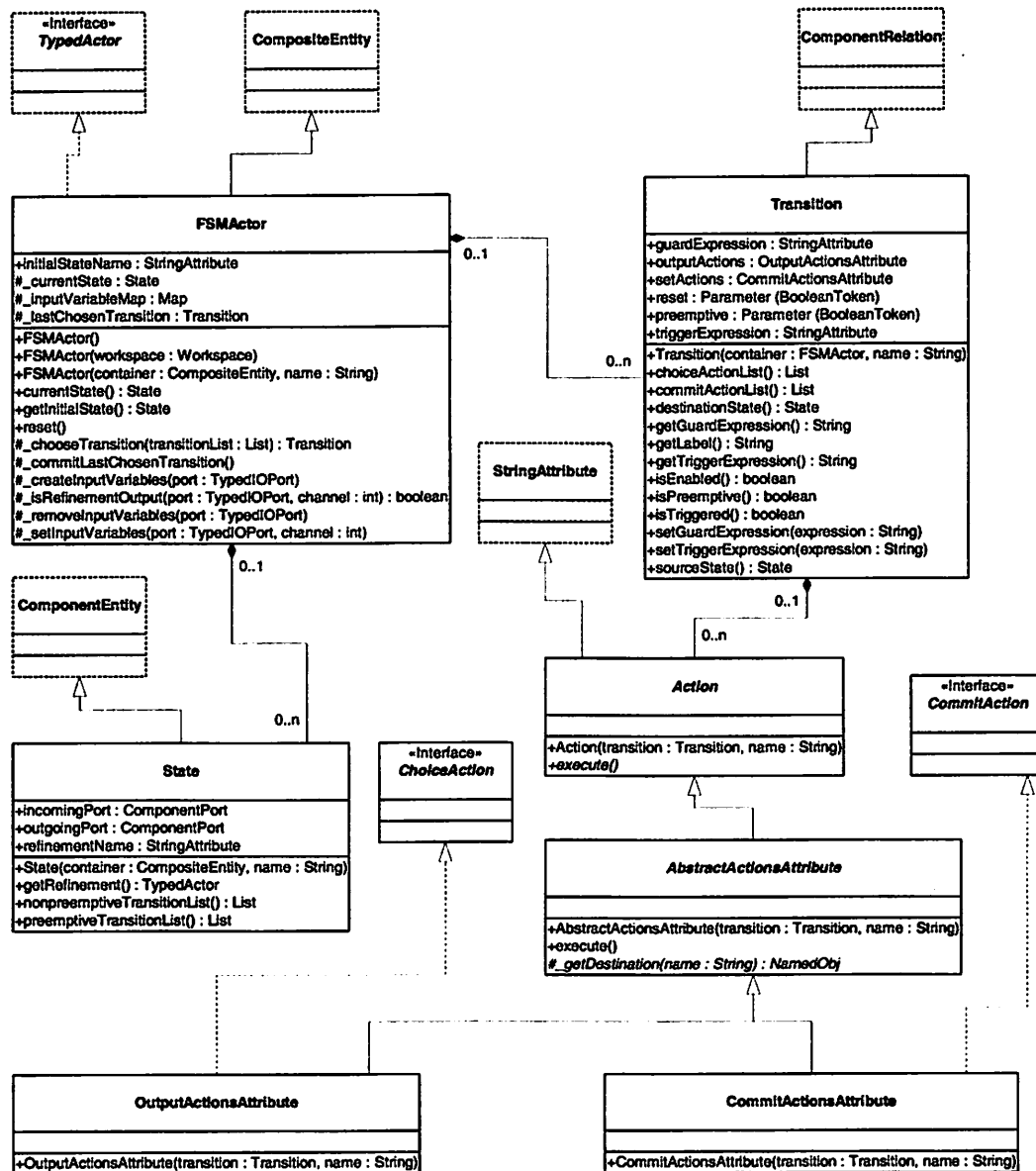

FIGURE 17.4. The UML static structure diagram of FSMActor-related classes.

in domains having fixed-point semantics, two kinds of actions are defined: choice actions and commit actions. Choice actions do not modify the extended state¹ of the FSM actor. They are executed when the FSM actor is fired and the containing transition is enabled. Commit actions may modify the extended state of the FSM actor. They are executed in `postfire()` if the containing transition was enabled in the last firing of the FSM actor. Two marker interfaces are defined in the FSM kernel package: `ChoiceAction`, which is implemented by all choice action classes, and `CommitAction`, implemented by all commit action classes.

A transition has an `outputActions` attribute which is an instance of `OutputActionsAttribute`. The `OutputActionsAttribute` class allows the user to specify a list of semicolon separated output actions of the form `destination = expression`. The expression can use parameters of the FSM actor and input variables. The destination is either a port name, in which case the result token from evaluating the expression is broadcast to all channels of the port, or of the form `portName (channelIndex)`, in which case the result token is sent to the specified channel. Output actions are choice actions.

- `outputActions: out = in1_isPresent ? in1 : 0`. Broadcast the input from port `in1`, or 0 if there is no input from `in1`, to the two channels of `out`.
- `outputActions: out (0) = param; out (1) = param + 1`. Send the value of `param` to the first channel of `out`, and the value of `param` plus 1 to the second channel.

A transition has a `setActions` attribute which is an instance of `CommitActionsAttribute`. The `CommitActionsAttribute` class allows the user to specify a list of semicolon separated commit actions of the form `destination = expression`. The expression can use parameters of the FSM actor and input variables. The destination is a parameter name.

- `setActions: param = param + (in1_isPresent ? in1 : 0)`. The input values from port `in1` are accumulated in `param`.

It is worth noting that parameter values are persistent. If not properly initialized, the parameter `t` in the above example will retain its accumulated value from previous model executions. A useful approach is to build the FSM model such that the initial state has an outgoing transition with guard expression `true`, and use the set actions of this transition for parameter initialization.

17.3.3 Execution

The methods that define the execution of an FSM actor are implemented as follows:

- `preinitialize()`: create receivers and input variables for each input port; set current state to the initial state as specified by the `initialStateName` attribute.
- `initialize()`: perform domain-specific initialization by calling the `initialize(Actor)` method of the director. Note that in the example given in section 17.2.1, the director will be the SDF director.
- `prefire()`: always return true. An FSM actor is always ready to fire.
- `fire()`: set the values of input variables; choose the enabled transition among the outgoing transitions of the current state; execute the choice actions of the chosen transition.
- `postfire()`: execute the commit actions of the last chosen transition; change state to the destination state of that transition.

Non-deterministic FSMs are not allowed². The `fire()` method checks whether there is more than one

1. The extended state of an FSM actor is the current state of the state machine it contains plus the set of current values of its parameters.
2. This may change in future developments.

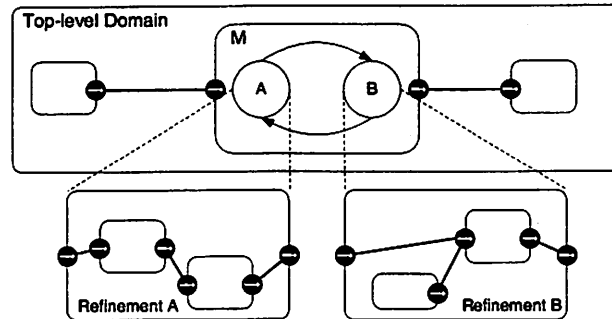

FIGURE 17.5. A modal model example.

enabled transition from the current state. An exception is thrown if there is. In the case when there is no enabled transition, the FSM will stay in its current state.

17.4 Modal Models

The FSM domain supports the **charts* formalism with modal models. The concept of modal model is illustrated in figure 17.5. *M* is a modal model with two operation modes. The modes are represented by states of an FSM that controls mode switching. Each mode has a refinement that specifies the behavior of the mode. In Ptolemy II, a modal model¹ is constructed in a typed composite actor having the FSM director as local director. The composite actor contains a mode controller (an FSM actor) and a set of actors that model the refinements. The FSM director mediates the interaction with the outside domain, and coordinates the execution of the refinements with the mode controller.

17.4.1 A Schmidt Trigger Example

In this section, we will illustrate how to build a modal model in Ptolemy II with a simple Schmidt trigger example. The output from the Schmidt trigger will move from -1.0 to 1.0 when its input becomes greater than 0.3, and will move back to -1.0 once its input becomes less than -0.3.

1. Open a Vergil graph editor. From utilities, drag a typed composite actor to the graph, rename it `SchmidtTrigger`. Add an input port named *in* and an output port named *out* to it.
2. Look inside `SchmidtTrigger`. This will open a graph editor for it. In this graph editor, drag an FSM actor to the graph, rename it `Controller`. Drag a typed composite actor to the graph, rename it `RefinementP`. Drag another typed composite actor to the graph, rename it `RefinementN`.
3. Add an input port named *in* to `Controller`. Add an output port named *out* for both `RefinementP` and `RefinementN`.
4. Look inside `Controller`. This will open an FSM editor for it. In this FSM editor, construct a two-state FSM as shown in figure 17.6. Set the reset parameter of both transitions to `true`. Set refinement name of state P to `RefinementP`. Set refinement name of state N to `RefinementN`. Set initial state name of `Controller` to `N`.

1. The current software architecture that supports modal models is experimental. A new approach based on higher order functions is in progress.

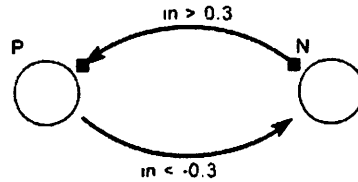

FIGURE 17.6. The mode controller for SchmidtTrigger.

5. Back to the graph editor for SchmidtTrigger. Look inside RefinementP. Build a model for it as shown in figure 17.7. Set the value of Const to 1.0. Edit parameters of Pulse: set indexes to {0, 1, 2, 3, 4}, and values to {-2.0, -1.6, -1.2, -0.8, -0.4}.
6. Back to the graph editor for SchmidtTrigger. Look inside RefinementN. Build a model for it as shown in figure 17.7. Set the value of Const to -1.0. Edit parameters of Pulse: set indexes to {0, 1, 2, 3, 4}, and values to {2.0, 1.6, 1.2, 0.8, 0.4}.
7. Back to the graph editor for SchmidtTrigger. Drag an FSM director to the graph. Set its controller-Name to Controller. Connect the actors as shown in figure 17.8.
8. Back to the graph editor opened in step 1. Build the model as shown in figure 17.9. The model generates an input signal (a sinusoid plus Gaussian noise) for the SchmidtTrigger and plots its output. Edit parameters of Ramp: set init to $-\pi/2$, and step to $\pi/20$. Edit parameters of Gaussian: set standardDeviation to 0.2.
9. Run the model for 200 iterations. A sample result is shown in figure 17.10.

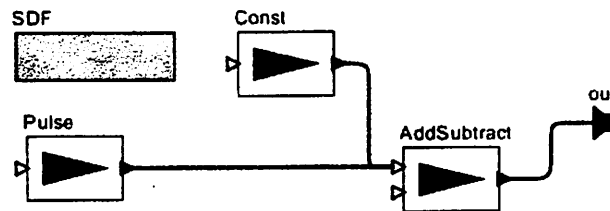

FIGURE 17.7. Model for the refinements in SchmidtTrigger.

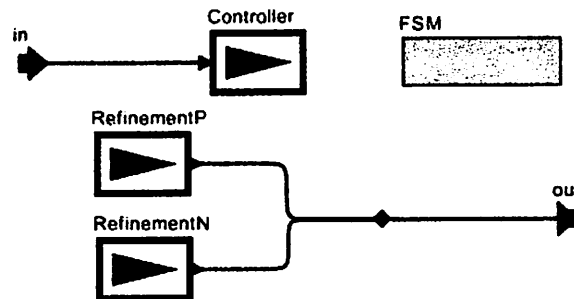

FIGURE 17.8. The SchmidtTrigger modal model.

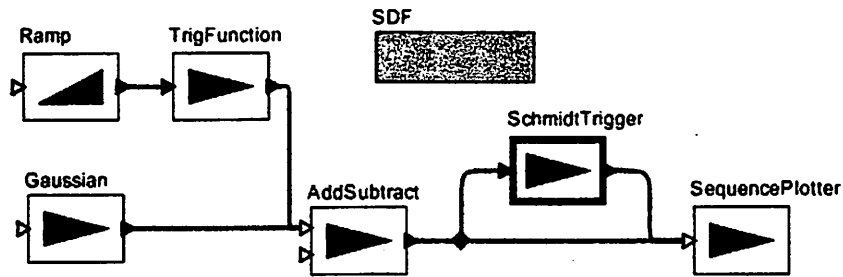

FIGURE 17.9. The top-level model with the SchmittTrigger.

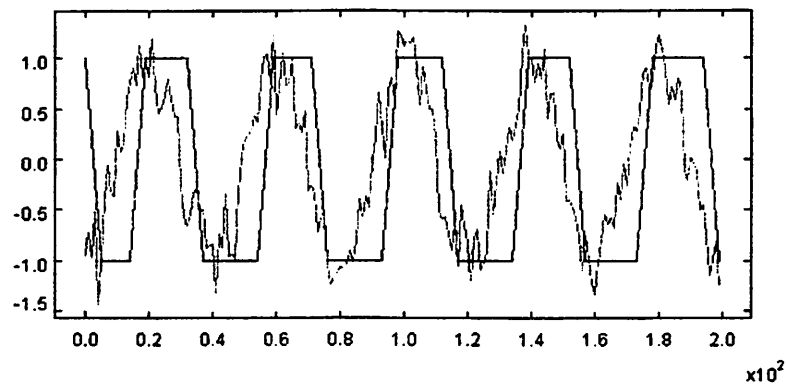

FIGURE 17.10. Sample result of the model shown in figure 17.9.

17.4.2 Implementation

The classes in the FSM kernel package that support modal models are shown in figure 17.11. The execution of a modal model is summarized below.

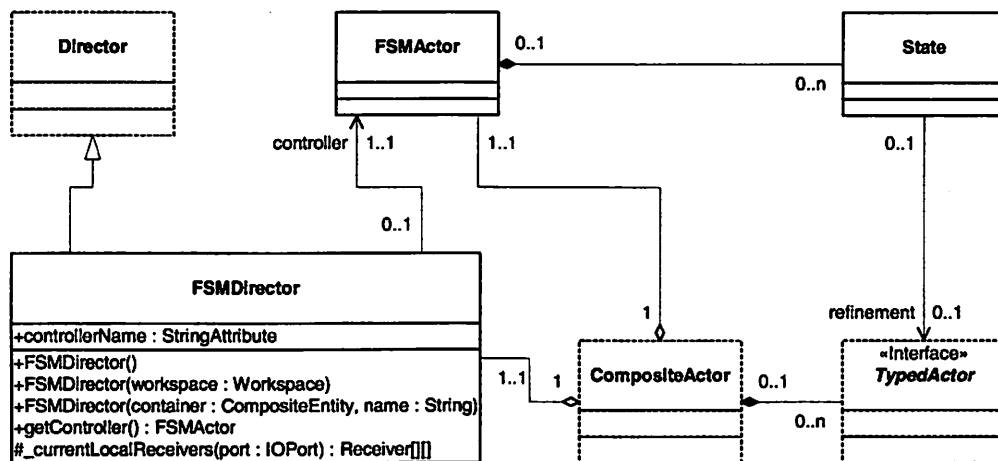

FIGURE 17.11. FSM kernel classes that support modal models.

When a modal model is fired:

1. The FSM director transfers the input tokens from the outside domain to the mode controller and to the refinement of its current state.
2. The preemptive transitions from the current state of the mode controller are examined. If there is an enabled transition, execute the choice actions of the transition, go to step 5.
3. Fire the refinement of the current state.
4. The non-preemptive transitions from the current state of the mode controller are examined. If there is an enabled transition, execute the choice actions of the transition.
5. Any output token produced by the mode controller or the refinement is transferred to the outside domain.

To make a transition preemptive, set its *preemptive* parameter to true. The mode controller does not change state during successive firings in one iteration in order to support outside domains that iterate to a fixed point. In `postfire()`, if there is an enabled transition in the latest firing:

1. Execute the commit actions of the transition.
2. Set the current state of the mode controller to the destination state of the transition.
3. If the value of the *reset* parameter of the transition is true, the refinement of the destination state is initialized.

17.4.3 Applications

Hybrid System Modeling. An `HSDirector` class that extends the `FSMDirector` class is created for modeling hybrid systems with FSMs and continuous-time (CT) models. An example is presented in section 14.6.3. Execution control is discussed in section 14.7.6.

Communication Protocol Modeling. Hierarchical FSMs are used to model protocol control logic. The timing characteristics of the communication channel are captured by discrete-event (DE) models. We have applied this approach to the alternating bit protocol. The detailed models can be found in the FSM domain demo directory (`$PTII/ptolemy/domains/fsm/demo/ABP`).

18

CSP Domain

Author: Neil Smyth
Contributors: John S. Davis II
Bilung Lee
Steve Neuendorffer

18.1 Introduction

The communicating sequential processes (CSP) domain in Ptolemy II models a system as a network of sequential processes that communicate by passing messages synchronously through channels. If a process is ready to send a message, it blocks until the receiving process is ready to accept the message. Similarly if a process is ready to accept a message, it blocks until the sending process is ready to send the message. This model of computation is non-deterministic as a process can be blocked waiting to send or receive on any number of channels. It is also highly concurrent.

The CSP domain is based on the model of computation (MoC) first proposed by Hoare [40][41] in 1978. In this MoC, a system is modeled as a network of processes communicate solely by passing messages through unidirectional channels. The transfer of messages between processes is via *rendezvous*, which means both the sending and receiving of messages from a channel are *blocking*: i.e. the sending or receiving process stalls until the message is transferred. Some of the notation used here is borrowed from Gregory Andrews' book on concurrent programming [4], which refers to rendezvous-based message passing as *synchronous message passing*.

Applications for the CSP domain include resource management and high level system modeling early in the design cycle. Resource management is often required when modeling embedded systems, and to further support this, a notion of time has been added to the model of computation used in the domain. This differentiates our CSP model from those more commonly encountered, which do not typically have any notion of time, although several versions of timed CSP have been proposed [38]. It might thus be more accurate to refer to the domain using our model of computation as the "Timed CSP" domain, but since it can be used with and without time, it is simply referred to as the CSP domain.

18.2 Using CSP

There are two basic issues that must be addressed when using the CSP domain:

- Unconditional vs. conditional rendezvous
- Time

18.2.1 Unconditional vs. Conditional Rendezvous

The basic communication statements `send()` and `get()` correspond to rendezvous communication in the CSP domain. Because of the domain framework, fact that a rendezvous is occurring on every communication is transparent to the actor code. However, this rendezvous is unconditional; an actor can only attempt to communicate on one port at a time. To realize the full power of the CSP domain, which allows non-deterministic rendezvous, it is necessary to write custom actors that use the conditional communication constructs in the `CSPActor` base class. There are three steps involved:

1) Create a `ConditionalReceive` or `ConditionalSend` branch for each guarded communication statement, depending on the communication. Pass each branch a unique integer identifier, starting from zero, when creating it.

2) Pass the branches to the `chooseBranch()` method in `CSPActor`. This method evaluates the guards, and decides which branch gets to rendezvous, performs the rendezvous and returns the identification number of the branch that succeeded. If all of the guards were false, -1 is returned.

3) Execute the statements for the guarded communication that succeeded.

A sample template for executing a conditional communication is shown in figure 18.1. This template corresponds to the CDO construct in CSP, described in section 18.3.2. In creating the `ConditionalSend` and `ConditionalReceive` branches, the first argument represents the guard. The second and third

```

boolean continueCDO = true;
while (continueCDO) {
    // step 1:
    ConditionalBranch[] branches = new ConditionalBranch[#branchesRequired];
    // Create a ConditionalReceive or a ConditionalSend for each branch
    // e.g. branches[0] = new ConditionalReceive(guard), input, 0, 0);

    // step 2:
    int result = chooseBranch(branches);

    // step 3:
    if (result == 0) {
        // execute statements associated with first branch
    } else if (result == 1) {
        // execute statements associated with second branch.
    } else if ... // continue for each branch ID

    } else if (result == -1) {
        // all guards were false so exit CDO.
        continueCDO = false;
    } else {
        // error
    }
}

```

FIGURE 18.1. Template for executing a CDO construct.

arguments represent the port and channel to send or receive the message on. The fourth argument is the identifier assigned to the branch. The choice of placing the guard in the constructor was made to keep the syntax of using guarded communication statements to the minimum, and to have the branch classes resemble the guarded communication statements they represent as closely as possible. This can give rise to the case where the Token specified in a ConditionalSend branch may not yet exist, but this has no effect because once the guard is false, the token in a ConditionalSend is never referenced.

The code for using a CIF is similar to that in figure 18.1 except that the surrounding while loop is omitted and the case when the identifier returned is -1 does nothing. At some stage the steps involved in using a CIF or a CDO may be automated using a pre-parser, but for now the user must follow the approach described above.

Figure 18.2 shows some actual code based on the template above that implements a buffer process. This process repeatedly rendezvous on its input port and its output port, buffering the data if the reading process is not yet ready for the writing process. It is worth pointing out that if most channels in a model are buffered in this way, it may be more reasonable to create the model in the PN domain which implicitly has an unbounded buffer on every channel.

18.2.2 Time

The CSP domain does not currently use the fireAt() mechanism to model time. If an actor wishes be delayed a certain amount of time during execution of the model, it must derive from CSPActor. Each process in the CSP domain is able to delay itself, either for some period from the current model time or until the next occasion time deadlock is reached at the current model time. The two methods to call are delay() and waitForDeadlock(). If a process delays itself for zero time from the current time, the pro-

```

boolean guard = false;
boolean continueCDO = true;
ConditionalBranch[] branches = new ConditionalBranch[2];
while (continueCDO) {
    // step 1
    guard = (_size < depth);
    branches[0] = new ConditionalReceive(guard, input, 0, 0);
    guard = (_size > 0);
    branches[1] = new ConditionalSend(guard, output, 0, 1, _buffer[_readFrom]);

    // step 2
    int successfulBranch = chooseBranch(branches);

    // step 3
    if (successfulBranch == 0) {
        _size++;
        _buffer[_writeTo] = branches[0].getToken();
        _writeTo = ++_writeTo % depth;
    } else if (successfulBranch == 1) {
        _size--;
        _readFrom = ++_readFrom % depth;
    } else if (successfulBranch == -1) {
        // all guards false so exit CDO
        // Note this cannot happen in this case
        continueCDO = false;
    } else {
        throw new TerminateProcessException(getName() + ": " +
            "branch id returned during execution of CDO.");
    }
}

```

FIGURE 18.2. Code used to implement the buffer process described in figure 18.1.

cess will continue immediately. Thus `delay(0.0)` is not equivalent to `waitForDeadlock()`

As far as each process is concerned, time can only increase while it is blocked waiting to rendezvous or when it is delayed. A process can be aware of the current model time, but it should only ever affect the model time by delaying its execution, thus forcing time to advance. The method `setCurrentTime()` should never be called from a process. However, if no processes are delayed, it is possible to set the model time by calling the `setCurrentTime()` method of the director. However, this method is present only for composing CSP with other domains.

By default every model in the CSP domain is timed. To use CSP without a notion of time, simply do not use the `delay()` method. The infrastructure supporting time does not affect the model execution if this method is not used. For more information about the semantics of Timed CSP models, see section 18.3.4

18.3 Properties of the CSP Domain

At the core of CSP communication semantics are two fundamental ideas. First is the notion of atomic communication and second is the notion of nondeterministic choice. It is worth mentioning a related model of computation known as the calculus of communicating systems (CCS) that was independently developed by Robin Milner in 1980 [65]. The communication semantics of CSP are identical to those of CCS.

18.3.1 Atomic Communication: Rendezvous

Atomic communication is carried out via rendezvous and implies that the sending and receiving of a message occur simultaneously. During rendezvous both the sending and receiving processes block until the other side is ready to communicate; the act of sending and receiving is indistinguishable activities since one can not happen without the other. A real world analogy to rendezvous can be found in telephone communications (without answering machines). Both the caller and callee must be simultaneously present for a phone conversation to occur. Figure 18.3 shows the case where one process is ready to send before the other process is ready to receive. The communication of information in this way can be viewed as a distributed assignment statement.

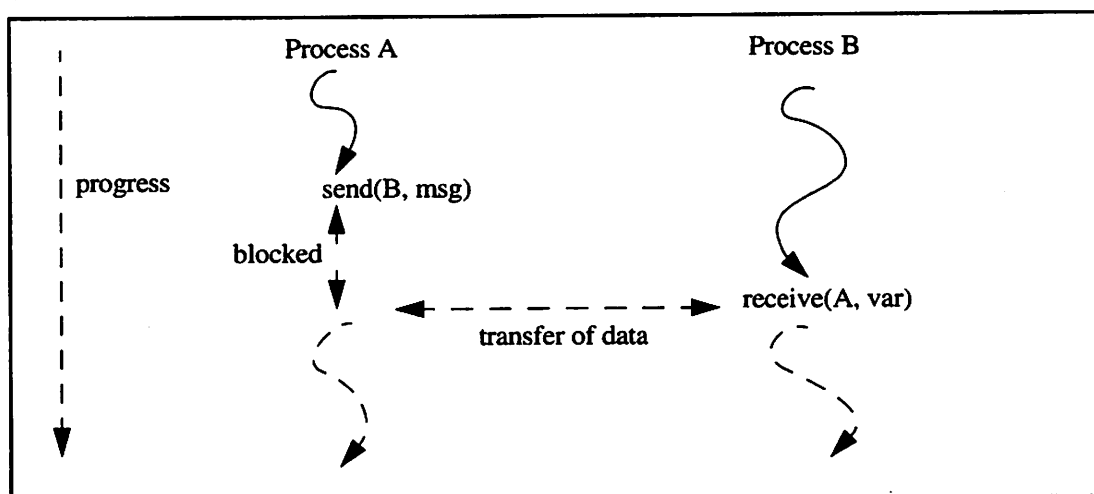

FIGURE 18.3. Illustrating how processes block waiting to rendezvous

The sending process places some data in the message that it wants to send. The receiving process assigns the data in the message to a local variable. Of course, the receiving process may decide to ignore the contents of the message and only concern itself with the fact that a message arrived.

18.3.2 Choice: Nondeterministic Rendezvous

Nondeterministic choice provides processes with the ability to randomly select between a set of possible atomic communications. We refer to this ability as nondeterministic rendezvous and herein lies much of the expressiveness of the CSP model of computation. The CSP domain implements nondeterministic rendezvous via *guarded communication statements*. A guarded communication statement has the form

```
guard; communication => statements;
```

The *guard* is only allowed to reference local variables, and its evaluation cannot change the state of the process. For example it is not allowed to assign to variables, only reference them. The *communication* must be a simple send or receive, i.e. another conditional communication statement cannot be placed here. *Statements* can contain any arbitrary sequence of statements, including more conditional communications.

If the guard is false, then the communication is not attempted and the statements are not executed. If the guard is true, then the communication is attempted, and if it succeeds, the following statements are executed. The guard may be omitted, in which case it is assumed to be true.

There are two conditional communication constructs built upon the guarded communication statements: **CIF** and **CDO**. These are analogous to the *if* and *while* statements in most programming languages. They should be read as “conditional if” and “conditional do”. Note that each guarded communication statement represents one *branch* of the CIF or CDO. The communication statement in each branch can be either a send or a receive, and they can be mixed freely.

CIF: The form of a CIF is

```
CIF {  
    G1; C1 => S1;  
    []  
    G2; C2 => S2;  
    []  
    ...  
}
```

For each branch in the CIF, the guard (*G1, G2,...*) is evaluated. If it is true (or absent, which implies true), then the associated communication statement is enabled. If one or more branch is enabled, then the entire construct blocks until one of the communications succeeds. If more than one branch is enabled, the choice of which enabled branch succeeds with its communication is made nondeterministically. Once the successful communication is carried out, the associated statements are executed and the process continues. If all of the guards are false, then the process continues executing statements after the end of the CIF.

It is important to note that, although this construct is analogous to the common *if* programming construct, its behavior is very different. In particular, all guards of the branches are evaluated concur-

rently, and the choice of which one succeeds does not depend on its position in the construct. The notation “[]” is used to hint at the parallelism in the evaluation of the guards. In a common *if*, the branches are evaluated sequentially and the first branch that is evaluated to true is executed. The CIF construct also depends on the semantics of the communication between processes, and can thus stall the progress of the thread if none of the enabled branches is able to rendezvous.

CDO: The form of the CDO is

```
CDO {
  G1;C1 => S1;
  []
  G2;C2 => S2;
  []
  ...
}
```

The behavior of the CDO is similar to the CIF in that for each branch the guard is evaluated and the choice of which enabled communication to make is taken non-deterministically. However, the CDO repeats the process of evaluating and executing the branches until *all* the guards return false. When this happens the process continues executing statements after the CDO construct.

An example use of a CDO is in a buffer process which can both accept and send messages, but has to be ready to do both at any stage. The code for this would look similar to that in figure 18.4. Note that in this case both guards can never be simultaneously false so this process will execute the CDO forever.

18.3.3 Deadlock

A deadlock situation is one in which none of the processes can make progress: they are all either blocked trying to rendezvous or they are delayed (see the next section). Thus, two types of deadlock can be distinguished:

real deadlock - all active processes are blocked trying to communicate

time deadlock - all active processes are either blocked trying to communicate or are delayed, and at least one process is delayed.

18.3.4 Time

In the CSP domain, *time* is centralized. That is, all processes in a model share the same time, referred to as the *current model time*. Each process can only choose to *delay* itself for some period relative to the current model time, or a process can wait for time deadlock to occur at the current model time. In both cases, a process is said to be *delayed*.

When a process delays itself for some length of time from the current model time, it is suspended

```
CDO {
  (room in buffer?); receive(input, beginningOfBuffer) => update pointer to beginning of buffer;
  []
  (messages in buffer?); send(output, endOfBuffer) => update pointer to end of buffer;
}
```

FIGURE 18.4. Example of how a CDO might be used in a buffer

until time has sufficiently advanced, at which stage it wakes up and continues. If the process delays itself for zero time, this will have no effect and the process will continue executing.

A process can also choose to delay its execution until the next occasion a time deadlock is reached. The process resumes at the same model time at which it delayed, and this is useful as a model can have several sequences of actions at the same model time. The next occasion time deadlock is reached, any processes delayed in this manner will continue, and time will not be advanced. An example of using time in this manner can be found in section 18.5.2.

Time may be *advanced* when all the processes are delayed or are blocked trying to rendezvous, and at least one process is delayed. If one or more processes are delaying until a time deadlock occurs, these processes are woken up and time is not advanced. Otherwise, the current model time is advanced just enough to wake up at least one process. Note that there is a semantic difference between a process delaying for zero time, which will have no effect, and a process delaying until the next occasion a time deadlock is reached.

Note also that time, as perceived by a single process, cannot change during its normal execution; only at rendezvous points or when the process delays can time change. A process can be aware of the centralized time, but it cannot influence the current model time except by delaying itself. The choice for modeling time was in part influenced by Pamela [30], a run time library that is used to model parallel programs.

18.3.5 Differences from Original CSP Model as Proposed by Hoare

The model of computation used by the CSP domain differs from the original CSP [40] model in two ways. First, a notion of time has been added. The original proposal had no notion of time, although there have been several proposals for timed CSP [38]. Second, as mentioned in section 18.3.2, it is possible to use both send and receive in guarded communication statements. The original model only allowed receives to appear in these statements, though Hoare subsequently extended their scope to allow both communication primitives [41].

One final thing to note is that in much of the CSP literature, send is denoted using a “!”, pronounced “bang”, and receive is denoted using a “?”, pronounced “query”. This syntax was what was used in the original CSP paper by Hoare. For example, the languages Occam [15] and Lotos [23] both follow this syntax. In the CSP domain in Ptolemy II we use *send* and *get*, the choice of which is influenced by the desire to maintain uniformity of syntax across domains in Ptolemy II that use message passing. This supports the heterogeneity principle in Ptolemy II which enables the construction and inter-operability of executable models that are built under a variety of models of computation. Similarly, the notation used in the CSP domain for conditional communication constructs differs from that commonly found in the CSP literature.

18.4 The CSP Software Architecture

18.4.1 Class Structure

In a CSP model, the director is an instance of *CSPDirector*. Since the model is controlled by a *CSPDirector*, all the receivers in the ports are *CSPReceivers*. The combination of the *CSPDirector* and *CSPReceivers* in the ports gives a model CSP semantics. The CSP domain associates each channel with exactly one receiver, located at the receiving end of the channel. Thus any process that sends or receives to any channel will rendezvous at a *CSPReceiver*. Figure 18.5 shows the static structure dia-

gram of the five main classes in the CSP kernel, and a few of their associations. These are the classes that provide all the infrastructure needed for a CSP model.

CSPDirector: This gives a model CSP semantics. It takes care of starting all the processes and controls/responds to both real and time deadlocks. It also maintains and advances the model time when necessary.

CSPReceiver: This ensures that communication of messages between processes is via rendezvous.

CSPActor: This adds the notion of time and the ability to perform conditional communication.

ConditionalReceive, *ConditionalSend*: This is used to construct the guarded communication statements necessary for the conditional communication constructs.

18.4.2 Starting the model

The director creates a thread for each actor under its control in its `initialize()` method. It also invokes the `initialize()` method on each actor at this time. The director starts the threads in its `prefire()` method, and detects and responds to deadlocks in its `fire()` method. The thread for each actor is an instance of `ProcessThread`, which invokes the `prefire()`, `fire()` and `postfire()` methods for the actor until it finishes or is terminated. It then invokes the `wrapup()` method and the thread dies.

Figure 18.7 shows the code executed by the `ProcessThread` class. Note that it makes no assumption about the actor it is executing, so it can execute any domain-polymorphic actor as well as CSP domain-specific actors. In fact, any other domain actor that does not rely on the specifics of its parent domain can be executed in the CSP domain by the `ProcessThread`.

18.4.3 Detecting deadlocks:

For deadlock detection, the director maintains three counts:

- the number of *active* processes which are threads that have started but have not yet finished
- the number of *blocked* processes which is the number of processes that are blocked waiting to rendezvous, and

```

director.initialize() =>
  create a thread for each actor
  update count of active processes with the director
  call initialize() on each actor

director.prefire() => start the process threads =>
  calls actor.prefire()
  calls actor.fire()
  calls actor.postfire()
  repeat.

director.fire() => handle deadlocks until a real deadlock occurs.

director.postfire() =>
  return a boolean indicating if the execution of the model should continue for another iteration

director.wrapup() => terminate all the processes =>
  calls actor.wrapup()
  decrease the count of active processes with the director

```

FIGURE 18.6. Sequence of steps involved in setting up and controlling the model.

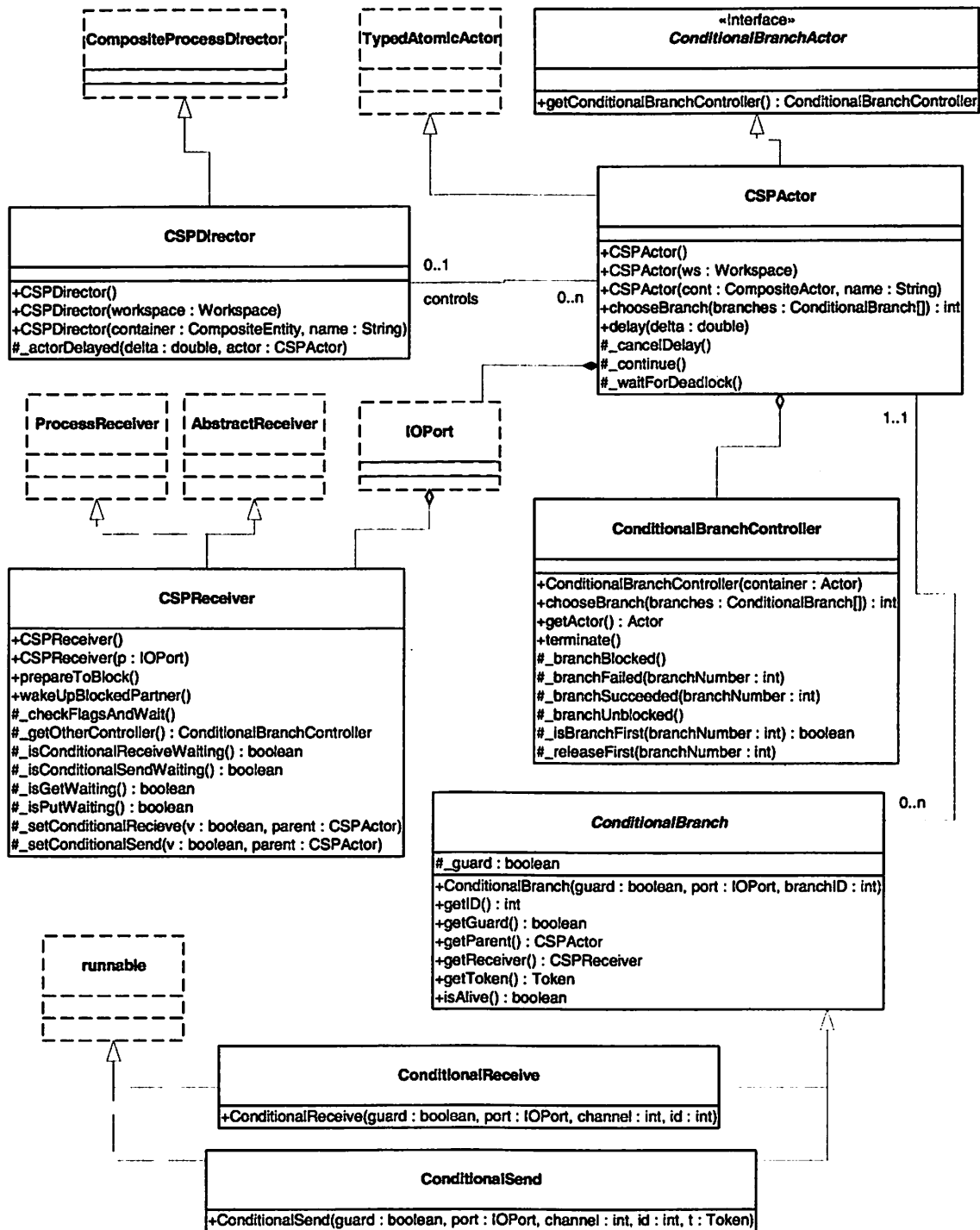

FIGURE 18.5. Static structure diagram for classes in the CSP kernel.

- the number of *delayed* processes, which is the number of processes waiting for time to advance plus the number of processes waiting for time deadlock to occur at the current model time.

When the number of blocked processes equals the number of active processes, then real deadlock has occurred and the fire method of the director returns. When the number of blocked plus the number of delayed processes equals the number of active processes, and at least one process is delayed, then time deadlock has occurred. If at least one process is delayed waiting for time deadlock to occur at the current model time, then the director wakes up all such processes and does not advance time. Otherwise the director looks at its list of processes waiting for time to advance, chooses the earliest one and advances time sufficiently to wake it up. It also wakes up any other processes due to be awakened at the new time. The director checks for deadlock each occasion a process blocks, delays or dies.

For the director to work correctly, these three counts need to be accurate at all stages of the model execution, so when they are updated becomes important. Keeping the active count accurate is relatively simple; the director increases it when it starts the thread, and decreases it when the thread dies. Likewise the count of delayed processes is straightforward; when a process delays, it increases the count of delayed processes, and the director keeps track of when to wake it up. The count is decreased when a delayed process resumes.

However, due to the conditional communication constructs, keeping the blocked count accurate requires a little more effort. For a basic send or receive, a process is registered as being blocked when it arrives at the rendezvous point before the matching communication. The blocked count is then decreased by one when the corresponding communication arrives. However what happens when an actor is carrying out a conditional communication construct? In this case the process keeps track of all of the branches for which the guards were true, and when all of those are blocked trying to rendezvous, it registers the process as being blocked. When one of the branches succeeds with a rendezvous, the process is registered as being unblocked.

```

public void run() {
    try {
        boolean iterate = true;
        while (iterate) {
            // container is checked for null to detect the termination
            // of the actor.
            iterate = false;
            if ((Entity)_actor).getContainer() != null && _actor.prefire() {
                _actor.fire();
                iterate = _actor.postfire();
            }
        }
    } catch (TerminateProcessException t) {
        // Process was terminated early
    } catch (IllegalActionException e) {
        _manager.fireExecutionError(e);
    } finally {
        try {
            _actor.wrapup();
        } catch (IllegalActionException e) {
            _manager.fireExecutionError(e);
        }
        _director.decreaseActiveCount();
    }
}

```

FIGURE 18.7. Code executed by `ProcessThread.run()`.

18.4.4 Terminating the model

A process can finish in one of two ways: either by returning false in its `prefire()` or `postfire()` methods, in which case it is said to have finished *normally*, or by being terminated *early* by a `TerminateProcessException`. For example, if a source process is intended to send ten tokens and then finish, it would exit its `fire()` method after sending the tenth token, and return false in its `postfire()` method. This causes the `ProcessThread`, see figure 18.7, representing the process, to exit the while loop and execute the finally clause. The finally clause calls `wrapup()` on the actor it represents, decreases the count of active processes in the director, and the thread representing the process dies.

A `TerminateProcessException` is thrown whenever a process tries to communicate via a channel whose receiver has its *finished* flag set to true. When a `TerminateProcessException` is caught in `ProcessThread`, the finally clause is also executed and the thread representing the process dies.

To terminate the model, the director sets the *finished* flag in each receiver. The next occasion a process tries to send to or receive from the channel associated with that receiver, a `TerminateProcessException` is thrown. This mechanism can also be used in a selective fashion to terminate early any processes that communicate via a particular channel. When the director controlling the execution of the model detects real deadlock, it returns from its `fire()` method. In the absence of hierarchy, this causes the `wrapup()` method of the director to be invoked. It is the `wrapup()` method of the director that sets the finished flag in each receiver. Note that the `TerminateProcessException` is a runtime exception so it does not need to be declared as being thrown.

There is also the option of abruptly terminating all the processes in the model by calling `terminate()` on the director. This method differs from the approach described in the previous paragraph in that it stops all the threads immediately and does not give them a chance to update the model state. After calling this method, the state of the model is unknown and so the model should be recreated after calling this method. This method is only intended for situations when the execution of the model has obviously gone wrong, and for it to finish normally would either take too long or could not happen. It should rarely be called.

18.4.5 Pausing/Resuming the Model

Pausing and resuming a model does not affect the outcome of a particular execution of the model, only the rate of progress. The execution of a model can be paused at any stage by calling the `pause()` method on the director. This method is blocking, and will only return when the model execution has been successfully paused. To pause the execution of a model, the director sets a *paused* flag in every receiver, and the next occasion a process tries to send to or receive from the channel associated with that receiver, it is paused. The whole model is paused when all the active processes are delayed, paused or blocked. To resume the model, the `resume()` method can similarly be called on the director. This method resets the paused flag in every receiver and wakes up every process waiting on a receiver lock. If a process was paused, it sees that it is no longer paused and continues. The ability to pause and resume the execution of a model is intended primarily for user interface control.

18.5 Example CSP Applications

Several example applications have been developed which serve to illustrate the modeling capabilities of the CSP model of computation in Ptolemy II. Each demonstration incorporates several features of CSP and the general Ptolemy II framework. The applications are described here, but not the code. See the directory `$PTII/ptolemy/domains/csp/demo` for the code.

The first demonstration, *dining philosophers*, serves as a natural example of core CSP communication semantics. This demonstration models nondeterministic resource contention, e.g., five philosophers randomly accessing chopstick resources. Nondeterministic rendezvous serves as a natural modeling tool for this example. The second example, *hardware bus contention*, models deterministic resource contention in the context of time. As will be shown, the determinacy of this demonstration constrains the natural nondeterminacy of the CSP semantics and results in difficulties. Fortunately these difficulties can be smoothly circumvented by the timing model that has been integrated into the CSP domain.

18.5.1 Dining Philosophers

Nondeterministic Resource Contention. This implementation of the dining philosophers problem illustrates both time and conditional communication in the CSP domain. Five philosophers are seated at a table with a large bowl of food in the middle. Between each pair of philosophers is one chopstick, and to eat, a philosopher needs both the chopsticks beside him. Each philosopher spends his life in the following cycle: thinks for a while, gets hungry, picks up one of the chopsticks beside him, then the other, eats for a while and puts the chopsticks down on the table again. If a philosopher tries to grab a chopstick but it is already being used by another philosopher, then the philosopher waits until that chopstick becomes available. This implies that no neighboring philosophers can eat at the same time and at most two philosophers can eat at a time.

The Dining Philosophers problem was first proposed by Edsger W. Dijkstra in 1965. It is a classic concurrent programming problem that illustrates the two basic properties of concurrent programming:

Liveness. How can we design the program to avoid deadlock, where none of the philosophers can make progress because each is waiting for someone else to do something?

Fairness. How can we design the program to avoid starvation, where one of the philosophers could make progress but does not because others always go first?

This implementation uses an algorithm that lets each philosopher randomly chose which chopstick to pick up first (via a CDO), and all philosophers eat and think at the same rates. Each philosopher and each chopstick is represented by a separate process. Each chopstick has to be ready to be used by either philosopher beside it at any time, hence the use of a CDO. After it is grabbed, it blocks waiting for a message from the philosopher that is using it. After a philosopher grabs both the chopsticks next to him, he eats for a random time. This is represented by calling `delay()` with the random interval to eat for. The same approach is used when a philosopher is thinking. Note that because messages are passed by rendezvous, the blocking of a philosopher when it cannot obtain a chopstick is obtained for free.

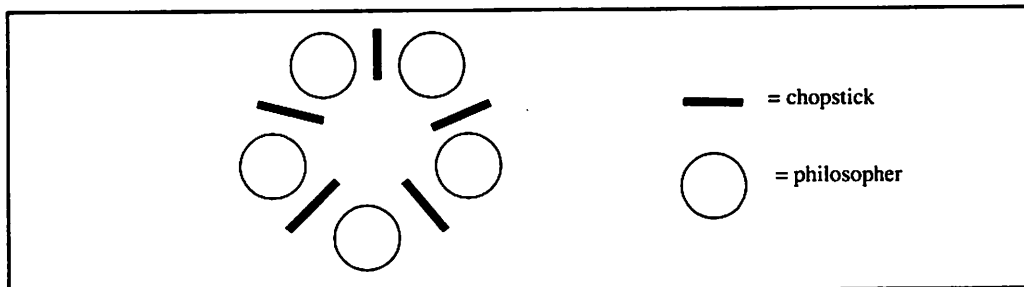

FIGURE 18.8. Illustration of the dining philosophers problem.

This algorithm is fair, as any time a chopstick is not being used, and both philosophers try to use it, they both have an equal chance of succeeding. However this algorithm does not guarantee the absence of deadlock, and if it is let run long enough this will eventually occur. The probability that deadlock occurs sooner increases as the thinking times are decreased relative to the eating times.

18.5.2 Hardware Bus Contention

Deterministic Resource Contention. This demonstration consists of a controller, N processors and a memory block, as shown in Figure 18.9. At randomly selected points in time, each processor requests permission from the controller to access the memory block. The processors each have priorities associated with them and in cases where there is a simultaneous memory access request, the controller grants permission to the processor with the highest priority. Due to the atomic nature of rendezvous, it is impossible for the controller to check priorities of incoming requests at the same time that requests are occurring. To overcome this difficulty, an alarm is employed. The alarm is started by the controller immediately following the first request for memory access at a given instant in time. It is awakened when a delay block occurs to indicate to the controller that no more memory requests will occur at the given point in time. Hence, the alarm uses CSP's notion of delay blocking to make deterministic an inherently non-deterministic activity.

18.6 Technical Details

18.6.1 Rendezvous Algorithm

In CSP, the locking point for all communication between processes is the receiver. Any occasion a process wishes to send or receive, it must first acquire the lock for the receiver associated with the channel it is communicating over. Two key facts to keep in mind when reading the following algorithms are that each channel has exactly one receiver associated with it and that at most one process can be trying to send to (or receive from) a channel at any stage. The constraint that each channel can have at most one process trying to send to (or receive from) a channel at any stage is not currently enforced, but an exception will be thrown if such a model is not constructed.

The rendezvous algorithm is *entirely symmetric* for the `put()` and the `get()`, except for the direction the token is transferred. This helps reduce the deadlock situations that could arise and also makes the interaction between processes more understandable and easier to explain. The algorithm controlling how a `get()` proceeds is shown in figure 18.10. The algorithm for a `put()` is exactly the same except that

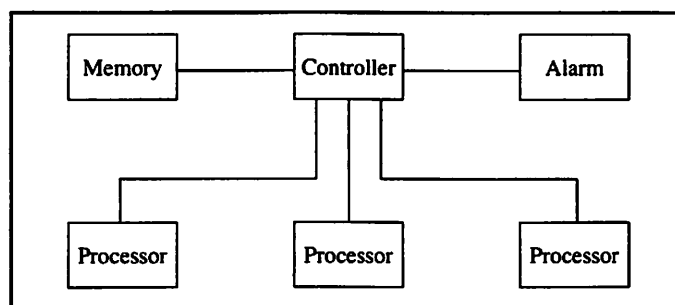

FIGURE 18.9. Illustration of the Hardware Bus Contention example.

put and get are swapped everywhere. Thus it suffices to explain what happens when a get() arrives at a receiver, i.e. when a process tries to receive from the channel associated with the receiver.

When a get() arrives at a receiver, a put() is either already waiting to rendezvous or it is not. Both the get() and put() methods are entirely synchronized on the receiver so they cannot happen simultaneously (only one thread can possess a lock at any given time). Without loss of generality assume a get() arrives before a put(). The rendezvous mechanism is basically three steps: a get() arrives, a put() arrives, the rendezvous completes.

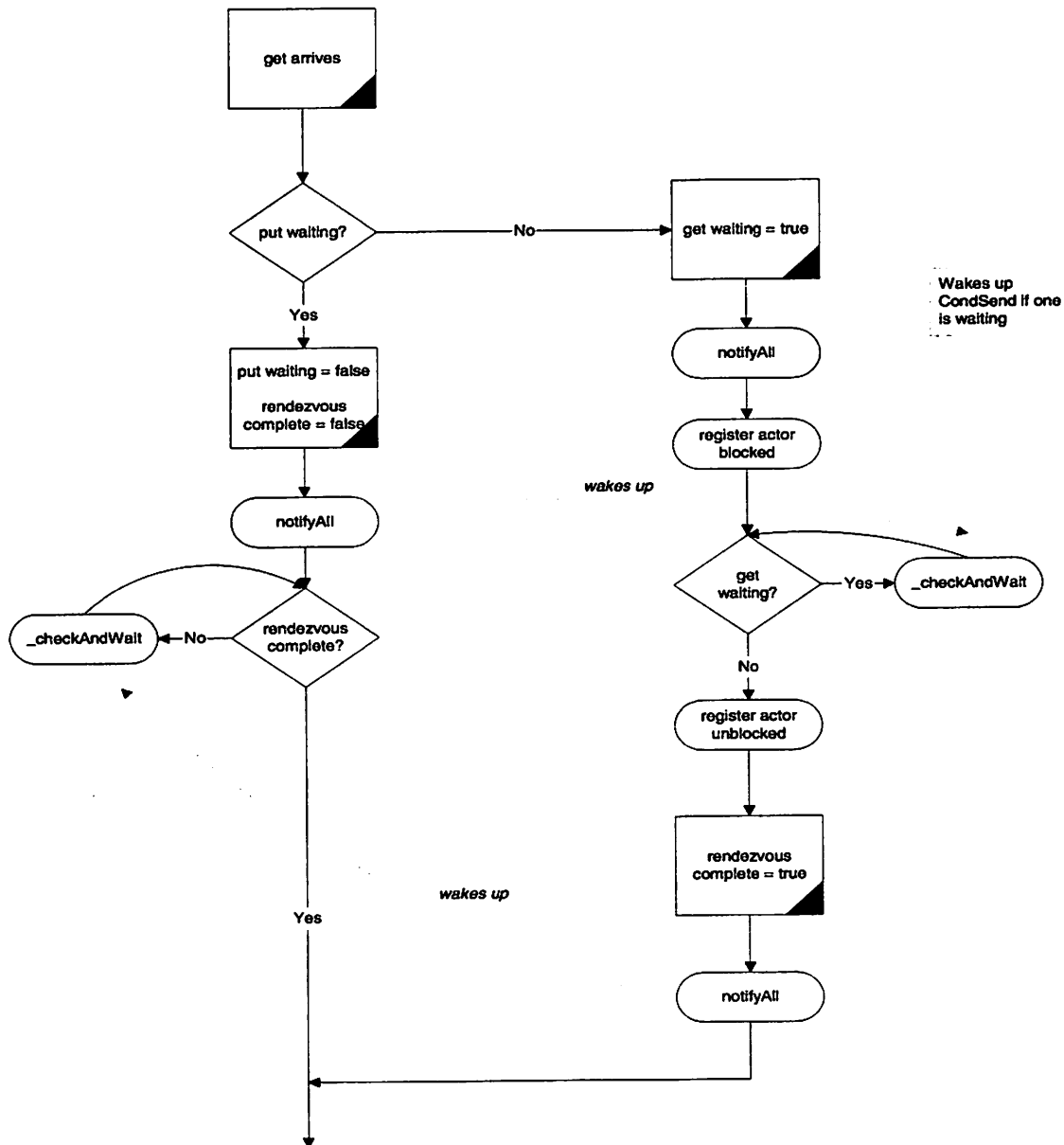

FIGURE 18.10. Rendezvous algorithm.

- (1) When the `get()` arrives, it sees that it is first and sets a flag saying a `get` is waiting. It then waits on the receiver lock while the flag is still true,
- (2) When a `put()` arrives, it sets the `getWaiting` flag to false, wakes up any threads waiting on the receiver (including the `get`), sets the `rendezvousComplete` flag to false and then waits on the receiver while the `rendezvousComplete` flag is false,
- (3) The thread executing the `get()` wakes up, sees that a `put()` has arrived, sets the `rendezvousComplete` flag to true, wakes up any threads waiting on the receiver, and returns thus releasing the lock. The thread executing the `put()` then wakes up, acquires the receiver lock, sees that the rendezvous is complete and returns.

Following the rendezvous, the state of the receiver is exactly the same as before the rendezvous arrived, and it is ready to mediate another rendezvous. It is worth noting that the final step, of making sure the second communication to arrive does not return until the rendezvous is complete, is necessary to ensure that the correct token gets transferred. Consider the case again when a `get()` arrives first, except now the `put()` returns immediately if a `get()` is already waiting. A `put()` arrives, places a token in the receiver, sets the `get` waiting flag to false and returns. Now suppose another `put()` arrives before the `get()` wakes up, which will happen if the thread the `put()` is in wins the race to obtain the lock on the receiver. Then the second `put()` places a new token in the receiver and sets the `put` waiting flag to true. Then the `get()` wakes up, and returns with the wrong token! This is known as a *race condition*, which will lead to unintended behavior in the model. This situation is avoided by our design.

18.6.2 Conditional Communication Algorithm

There are two steps involved in executing a CIF or a CDO: first deciding which enabled branch succeeds, then carrying out the rendezvous.

Built on top of rendezvous:

When a conditional construct has more than one enabled branch (guard is true or absent), a new thread is spawned for each enabled branch. The job of the `chooseBranch()` method is to control these threads and to determine which branch should be allowed to successfully rendezvous. These threads and the mechanism controlling them are entirely separate from the rendezvous mechanism described in section 18.6.1, with the exception of one special case, which is described in section 18.6.3. Thus the conditional mechanism can be viewed as being built on top of basic rendezvous: conditional communication knows about and needs basic rendezvous, but the opposite is not true. Again this is a design decision which leads to making the interaction between threads easier to understand and is less prone to deadlock as there are fewer interaction possibilities to consider.

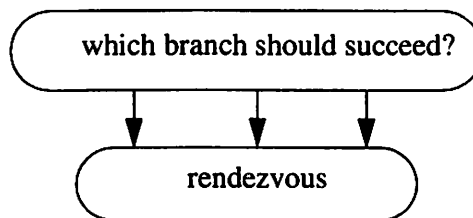

FIGURE 18.11. Conceptual view of how conditional communication is built on top of rendezvous.

Choosing which branch succeeds.

The manner in which the choice of which branch can rendezvous is worth explaining. The `chooseBranch()` method in `CSPActor` takes an array of branches as an argument. If all of the guards are false, it returns -1, which indicates that all the branches failed. If exactly one of the guards is true, it performs the rendezvous directly and returns the identification number of the successful branch. The interesting case is when more than one guard is true. In this case, it creates and starts a new thread for each branch whose guard is true. It then waits, on an internal lock, for one branch to succeed. At that point it gets woken up, sets a finished flag in the remaining branches and waits for them to fail. When all the threads representing the branches are finished, it returns the identification number of the successful branch. This approach is designed to ensure that exactly one of the branches created successfully performs a rendezvous.

Algorithm used by each branch:

Similar to the approach followed for rendezvous, the algorithm by which a thread representing a branch determines whether or not it can proceed is entirely *symmetrical* for a `ConditionalSend` and a `ConditionalReceive`. The algorithm followed by a `ConditionalReceive` is shown figure 18.12. Again the locking point is the receiver, and all code concerned with the communication is synchronized on the receiver. The receiver is also where all necessary flags are stored.

Consider three cases.

(1) a `conditionalReceive` arrives and a put is waiting.

In this case, the branch checks if it is the first branch to be ready to rendezvous, and if so, it goes ahead and executes a `get`. If it is not the first, it waits on the receiver. When it wakes up, it checks if it is still alive. If it is not, it registers that it has failed and dies. If it is still alive, it starts again by trying to be the first branch to rendezvous. Note that a put cannot disappear.

(2) a `conditionalReceive` arrives and a `conditionalSend` is waiting

When both sides are conditional branches, it is up to the branch that arrives second to check whether the rendezvous can proceed. If both branches are the first to try to rendezvous, the `conditionalReceive` executes a `get()`, notifies its parent that it succeeded, issues a `notifyAll()` on the receiver and dies. If not, it checks whether it has been terminated by `chooseBranch()`. If it has, it registers with `chooseBranch()` that it has failed and dies. If it has not, it returns to the start of the algorithm and tries again. This is because a `ConditionalSend` could disappear. Note that the parent of the first branch to arrive at the receiver needs to be stored for the purpose of checking if both branches are the first to arrive.

This part of the algorithm is somewhat subtle. When the second conditional branch arrives at the rendezvous point it checks that *both* sides are the first to try to rendezvous for their respective processes. If so, then the `conditionalReceive` executes a `get()`, so that the `conditionalSend` is never aware that a `conditionalReceive` arrived: it only sees the `get()`.

(3) a `conditionalReceive` arrives first.

It sets a flag in the receiver that it is waiting, then waits on the receiver. When it wakes up, it checks whether it has been killed by `chooseBranch`. If it has, it registers with `chooseBranch` that it has failed and dies. Otherwise it checks if a put is waiting. It only needs to check if a put is waiting because if a `conditionalSend` arrived, it would have behaved as in case (2) above. If a put is waiting, the branch checks if it is the first branch to be ready to rendezvous, and if so it goes ahead

the algorithm is shown in the dashed ellipse in figure 18.13. It does not affect the algorithm except in the case when a conditional send is waiting when a get arrives at the receiver. In this case the process that calls the get should wait on the receiver until the conditional send waiting flag is false. If the conditional send succeeded, and hence executed a put, then the get waiting flag and the conditional send waiting flag should both be false and the actor proceeds through to the third step of the rendezvous. If the conditional send failed, it will have reset the conditional send waiting flag and issued a notifyAll() on the receiver, thus waking up the get and allowing it to properly wait for a put.

The same reasoning also applies to the case when a conditional receive arrives at a receiver before a put.

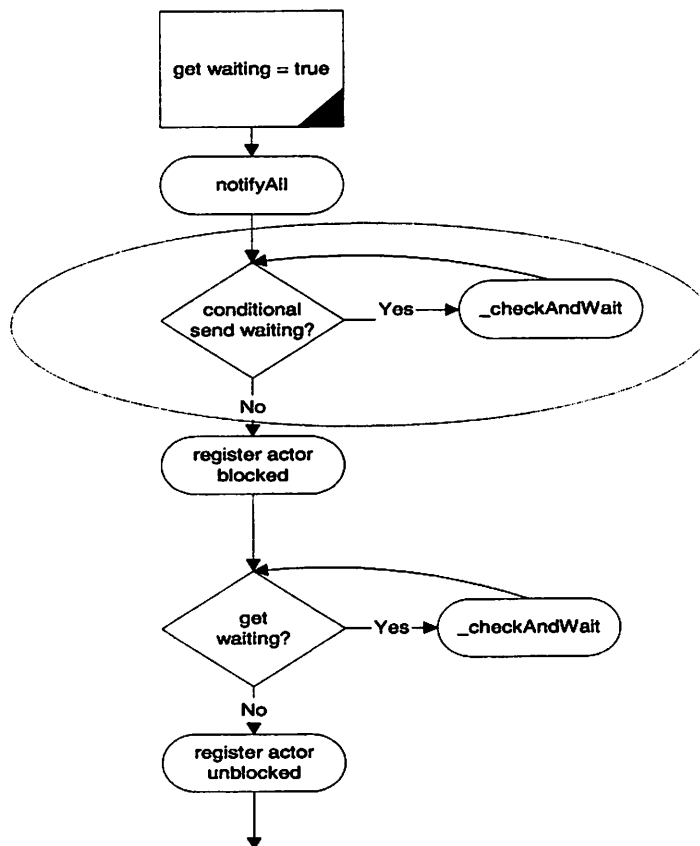

FIGURE 18.13. Modification of rendezvous algorithm, section 18.6.3, shown in ellipse.

19

DDE Domain

Author: John S. Davis II

19.1 Introduction

The distributed discrete event (DDE) model of computation incorporates a distributed notion of time into a dataflow style of communication. Time progresses in a DDE model when the actors in the model execute and communicate. Actors in a DDE model communicate by sending messages through bounded, FIFO channels. Time in a DDE model is distributed and localized, and the actors of a DDE model each maintain their own local notion of the current time. Local time information is shared between two connected actors whenever a communication between said actors occurs. Conversely, communication between two connected actors can occur only when constraints on the relative local time information of the actors are adhered to.

The DDE domain is based on distributed discrete event processing and leverages a wealth of research devoted to this topic. Several tutorial publications on this topic exist in [19][27][43][67]. The DDE domain implements a specific variant of distributed discrete event systems (DDES) as expounded by Chandy and Misra [19]. While the DDE domain has similarities with DDES, the distributed discrete event domain serves as a framework for studying DDES with two special emphases. First we consider DDES from a dataflow perspective; we view DDE as an implementation of the Kahn dataflow model [45] with distributed time added on top. Second we study DDES not with the goal of improving execution speed (as has been the case traditionally). Instead we study DDES to learn its usefulness in modeling and designing systems that are timed and distributed.

19.2 Using DDE

The DDE domain is typed so that actors used in a model must be derived from `ptolemy/actor/TypedAtomicActor`. The DDE domain is designed to use both DDE specific actors as well as polymorphic actors. DDE specific actors take advantage of `DDEActor` and `DDEIOPort` which are designed to provide convenient support for specifying time in the production and consumption of tokens. The DDE

domain also has special restrictions on how feedback is specified in models.

19.2.1 DDEActor

The DDE model of computation makes one very strong assumption about the execution of an actor: *all input ports of an actor operating in a DDE model must be regularly polled to determine which input channel has the oldest pending event.* Any actor that adheres to this assumption can operate in a DDE model. Thus, many polymorphic actors found in `ptolemy/actor/[lib, gui]` are suitable for operation in DDE models. For convenience, DDEActor was developed to simplify the construction of actors that have DDE semantics. DDEActor has three key methods as follows:

getNextToken(). This method polls each input port of an actor and returns the (non-Null) token that represents the oldest event. This method blocks accordingly as outlined in section 19.3.1 (Communicating Time).

getLastPort(). This method returns the input IOPort from which the last (non-Null) token was consumed. This method presumes that *getNextToken()* is being used for token consumption.

19.2.2 DDEIOPort

DDEIOPort extends TypedIOPort with parameters for specifying time stamp values of tokens that are being sent to neighboring actors. Since DDEIOPort extends TypedIOPort, use of DDEIOPorts will not violate the type resolution protocol. DDEIOPort is not necessary to facilitate communication between actors executing in a DDE model; standard TypedIOPorts are sufficient in most communication. DDEIOPorts become useful when the time stamp to be associated with an outgoing token is greater than the current time of the sending actor. Hence, DDEIOPorts are only useful in conjunction with delay actors (see “Enabling Communication: Advancing Time” on page 19-3, for a definition of delay actor). Most polymorphic actors available for Ptolemy II are not delay actors.

19.2.3 Feedback Topologies

In order to execute feedback topologies that will not deadlock, FeedbackDelay actors must be used. FeedbackDelay is found in the DDE kernel package. FeedbackDelay actors do not perform computation, but instead increment the time stamps of tokens that flow through them by a specified delay. The delay value of a FeedbackDelay actor must be chosen to be less than the delta time of the feedback cycle in which the FeedbackDelay actor is contained. Elaborate delay values can be specified by overriding the *getDelay()* method in subclasses of FeedbackDelay. An example of such can be found in `ptolemy/domains/dde/demo/LocalZeno/ZenoDelay.java`.

A difficulty found in feedback cycles occurs in the initialization of a model’s execution. In figure 19.1 we see that even if Actor B is a FeedbackDelay actor, the system will deadlock if the first event is created by A since C will block on an event from B. To alleviate this problem a special time stamp

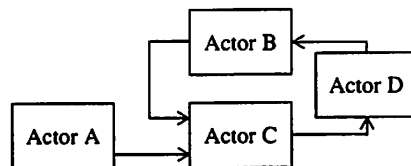

FIGURE 19.1. Initializing Feedback Topologies

value has been reserved: `PrioritizedTimedQueue.IGNORE`. When an actor encounters an event with a time stamp of `IGNORE` (an *ignore event*), the actor will ignore the event and the input channel it is associated with. The actor then considers the other input channels in determining the next available event. After a non-ignore event is encountered and consumed by the actor, all ignore events will be cleared from the receivers. If all of an actor's input channels contain ignore events, then the actor will clear all ignore events and then proceed with normal operation.

The `initialize` method of `FeedBackDelay` produces an ignore event. Thus, in figure 19.1, if *B* is a `FeedBackDelay` actor, the ignore event it produces will be sent to *C*'s upper input channel allowing *C* to consume the first event of *A*. The production of null tokens and feedback delays will then be sufficient to continue execution from that point on. Note that the production of an ignore event by a `FeedBackDelay` actor serves as a major distinction between it and all other actors. *If a delay is desired simply to represent the computational delay of a given model, a FeedBackDelay actor should not be used.*

The intricate operation of ignore events requires special consideration when determining the position of a `FeedBackDelay` actor in a feedback topology. A `FeedBackDelay` actor should be placed so that the ignore event it produces will be ignored in deference to the first real event that enters a feedback cycle. Thus, choosing actor *D* as a `FeedBackDelay` actor in figure 19.1 would not be useful given that the first real event entering the cycle is created by *A*.

19.3 Properties of the DDE domain

Operationally, the semantics of the DDE domain can be separated into two functionalities. The first functionality relates to how time advances during the communication of data and how communication proceeds via blocking reads and writes. The second functionality considers how a DDE model prevents deadlock due to local time dependencies. The technique for preventing deadlock involves the communication of *null messages* that consist solely of local time information.

19.3.1 Enabling Communication: Advancing Time

Communicating Tokens. A DDE model consists of a network of sequential actors that are connected via unidirectional, bounded, FIFO queues. Tokens are sent from a sending actor to a receiving actor by placing a token in the appropriate queue where the token is stored until the receiving actor consumes it. If a process attempts to read a token from a queue that is empty, then the process will block until a token becomes available on the channel. If a process attempts to write a token to a queue that is full, then the process will block until space becomes available for more tokens in that queue. Note that this blocking read/write paradigm is equivalent to the operational semantics found in non-timed process networks (PN) as implemented in Ptolemy II (see the PN Domain chapter).

If all processes in a DDE model simultaneously block, then the model deadlocks. Deadlock that is due to processes that are either waiting to read from an empty queue, *read blocks*, or waiting to write to a full queue, *write blocks*, then we say that the model has experienced *non-timed deadlock*. Non-timed deadlock is equivalent to the notion of deadlock found in bounded process networks scheduling problems as outlined by Parks [75]. If a non-timed deadlock is due to a model that consists solely of processes that are read blocked, then we say that a *real deadlock* has occurred and the model is terminated. If a non-timed deadlock is due to a model that consists of at least one process that is write blocked, then the capacity of the full queues are increased until deadlock no longer exists. Such deadlocks are called *artificial deadlock*, and the policy of increasing the capacity of full queues was shown by Parks

to guarantee the execution of a model in bounded memory whenever possible.

Communicating Time. Each actor in a DDE model maintains a local notion of time. Any non-negative real number may serve as a valid value of time. As tokens are communicated between actors, time stamps are associated with each token. Whenever an actor consumes a token, the actor's *current time* is set to be equal to that of the consumed token's time stamp. The time stamp value applied to outgoing tokens of an actor is equivalent to that actor's *output time*. For actors that model a process in which there is delay between incoming time stamps and corresponding outgoing time stamps, then the output time is always greater than the current time; otherwise, the output time is equal to the current time. We refer to actors of the former case as *delay actors*.

For a given queue containing time stamped tokens, the time stamp of the first token currently contained by the queue is referred to as the *receiver time* of the queue. If a queue is empty, its receiver time is the value of the time stamp associated with the last token to flow through the queue, or 0.0 if no tokens have traveled through the queue. An actor may consume a token from an input queue given that the queue has a token available and the receiver time of the queue is less than the receiver times of all other input queues contained by the actor. If the queue with the smallest receiver time is empty, then the actor blocks until this queue receives a token, at which time the actor considers the updated receiver time in selecting a queue to read from. The *last time* of a queue is the time stamp of the last token to be placed in the queue. If no tokens have been placed in the queue, then the last time is 0.0

Figure 19.2 shows three actors, each with three input queues. Actor *A* has two tokens available on the top queue, no tokens available on the middle queue and one token available on the bottom queue. The receiver times of the top, middle and bottom queue are respectively, 17.0, 12.0 and 15.0. Since the queue with the minimum receiver time (the middle queue) is empty, *A* blocks on this queue before it proceeds. In the case of actor *B*, the minimum receiver time belongs to the bottom queue. Thus, *B* proceeds by consuming the token found on the bottom queue. After consuming this token, *B* compares all of its receiver times to determine which token it can consume next. Actor *C* is an example of an actor that contains multiple input queues with identical receiver times. To accommodate this situation, each actor assigns a unique priority to each input queue. An actor can consume a token from a queue if no other queue has a lower receiver time and if all queues that have an identical receiver time also have a lower priority.

Each receiver has a *completion time* that is set during the initialization of a model. The completion time of the receiver specifies the time after which the receiver will no longer operate. If the time stamp of the oldest token in a receiver exceeds the completion time, then that receiver will become *inactive*.

19.3.2 Maintaining Communication: Null Tokens

Deadlocks can occur in a DDE model in a form that differs from the deadlocks described in the previous section. This alternative form of deadlock occurs when an actor read blocks on an input port

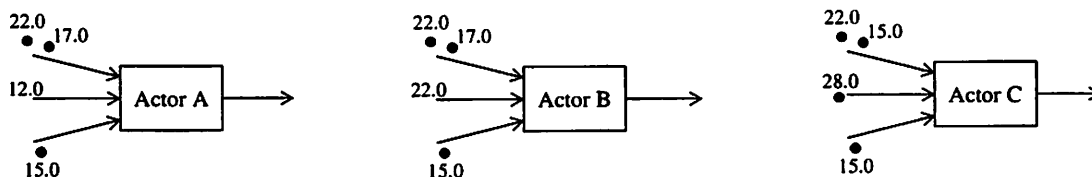

FIGURE 19.2. DDE actors and local time.

even though it contains other ports with tokens. The topology of a DDE model can lead to deadlock as read blocked actors wait on each other for time stamped tokens that will never appear. Figure 19.3 illustrates this problem. In this topology, consider a situation in which actor *A* only creates tokens on its lower output queue. This will lead to tokens being created on actor *C*'s output queue but no tokens will be created on *B*'s output queue (since *B* has no tokens to consume). This situation results in *D* read blocking indefinitely on its upper input queue even though it is clear that no tokens will ever flow through this queue. The result: *timed deadlock!* The situation shown in figure 19.3 is only one example of timed deadlock. In fact there are two types of timed deadlock: *feedforward* and *feedback*.

Figure 19.3 is an example of feedforward deadlock. Feedforward deadlock occurs when a set of connected actors are deadlocked such that all actors in the set are read blocked and at least one of the actors in the set is read blocked on an input queue that has a receiver time that is less than the local clock of the input queue's source actor. In the example shown above, the upper input queue of *B* has a receiver time of 0.0 even though the local clock of *A* has advanced to 8.0.

Feedback deadlock occurs when a set of cyclically connected actors are deadlocked such that all actors in the set are read blocked and at least one actor in the set, say actor *X*, is read blocked on an input queue that can read tokens which are directly or indirectly a result of output from that same actor (actor *X*). Figure 19.4 is an example of feedback timed deadlock. Note that *B* can not produce an output based on the consumption of the token timestamped at 5.0 because it must wait for a token on the upper input that depends on the output of *B*!

Preventing Feedforward Timed Deadlock. To address feedforward timed deadlock, *null tokens* are employed. A null token provides an actor with a means of communicating time advancement even though data (*real tokens*) are not being transmitted. Whenever an actor consumes a token, it places a null token on each of its output queues such that the time stamp of the null token is equal to the current time of the actor. Thus, if actor *A* of figure 19.3, produced a token on its lower output queue at time 5.0, it would also produce a null token on its upper output queue at time 5.0.

If an actor encounters a null token on one of its input queues, then the actor does the following. First it consumes the tokens of all other input queues it contains given that the other input queues have receiver times that are less than or equal to the time stamp of the null token. Next the actor removes the null token from the input queue and sets its current time to equal the time stamp of the null token. The actor then places null tokens time stamped to the current time on all output queues that have a last time

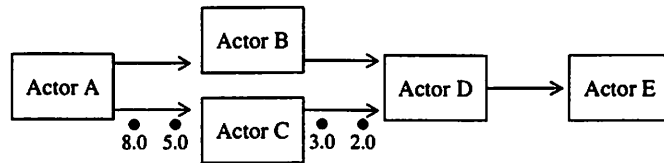

FIGURE 19.3. Timed deadlock (feedforward).

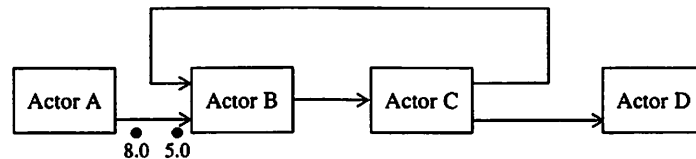

FIGURE 19.4. Timed Deadlock (Feedback)

that is less than the actor's current time. As an example, if *B* in figure 19.3 consumes a null token on its input with a time stamp of 5.0 then it would also produce a null token on its output with a time stamp of 5.0.

The result of using null tokens is that time information is evenly propagated through a model's topology. The beauty of null tokens is that they inform actors of inactivity in other components of a model without requiring centralized dissemination of this information. Given the use of null tokens, feedforward timed deadlock is prevented in the execution of DDE models. It is important to recognize that null tokens are used solely for the purpose of avoiding deadlocks. Null tokens do not represent any actual components of the physical system being modeled. Hence, we do not think of a null token as a real token. Furthermore, the production of a null token that is the direct result of the consumption of a null token is not considered computation from the standpoint of the system being modeled. The idea of null tokens was first espoused by Chandy and Misra [19].

Preventing Feedback Timed Deadlock. We address feedback timed deadlock as follows. All feedback loops are required to have a cumulative time stamp increment that is greater than zero. In other words, feedback loops are required to contain delay actors. Peacock, Wong and Manning [76] have shown that a necessary condition for feedback timed deadlock is that a feedback loop must contain no delay actors. The delay value (delay = output time - current time) of a delay actor must be chosen wisely; it must be less than the smallest delta time of all other actors contained in the same feedback loop. *Delta time* is the difference between the time stamps of a token that is consumed by an actor and the corresponding token that is produced in direct response. If a system being modeled has characteristics that prevent a fixed, positive lower bound on delta time from being specified, then our approach can not solve feedback timed deadlock. Such a situation is referred to as a *Zeno condition*. An application involving an approximated Zeno condition is discussed in section 19.5 below.

The DDE software architecture provides one delay actor for use in preventing feedback timed deadlock: *FeedBackDelay*. See "Feedback Topologies" on page 19-2 for further details about this actor.

19.3.3 Alternative Distributed Discrete Event Methods

The field of distributed discrete event simulation, also referred to as parallel discrete event simulation (PDES), has been an active area of research since the late 1970's [19][27][43][67][76]. Recently there has been a resurgence of activity [5][6][11]. This is due in part to the wide availability of distributed frameworks for hosting simulations and the application of parallel simulation techniques to non-research oriented domains. For example, several WWW search engines are based on network of workstation technology.

The field of distributed discrete event simulation can be cast into two camps that are distinguished by the blocking read approach taken by the actors. One camp was introduced by Chandy and Misra [19][27][67][76] and is known as *conservative* blocking. The second camp was introduced by David Jefferson through the Jet Propulsion Laboratory Time Warp system and is referred to as the *optimistic* approach [43][27]. In certain problems, the optimistic approach executes faster than the conservative approach, nevertheless, the gains in speed result in significant increases in program memory. The conservative approach does not perform faster than the optimistic approach but it executes efficiently for all classes of discrete event systems. Given the modeling semantics emphasis of Ptolemy II, performance (speed) is not considered a premium. Furthermore, Ptolemy II's embedded systems emphasis suggests that memory constraints are likely. For these reasons, the implementation found in the DDE domain follows the conservative approach.

19.4 The DDE Software Architecture

For a model to have DDE semantics, it must have a DDEDirector controlling it. This ensures that the receivers in the ports are DDEReceiver. Each actor in a DDE model is under the control of a DDEThread. DDEThreads contain a TimeKeeper that manages the local notion of time that is associated with the DDEThread's actor.

19.4.1 Local Time Management

The UML diagram of the local time management system of the DDE domain is shown in figure 19.5 and consists of PrioritizedTimedQueue, DDEReceiver, DDEThread and TimeKeeper. Since time is localized, the DDEDirector does not have a direct role in this process. Note that DDEReceiver is derived from PrioritizedTimedQueue. The primary purpose of PrioritizedTimedQueue is to keep track of a receiver's local time information. DDEReceiver adds blocking read/write functionality to PrioritizedTimedQueue.

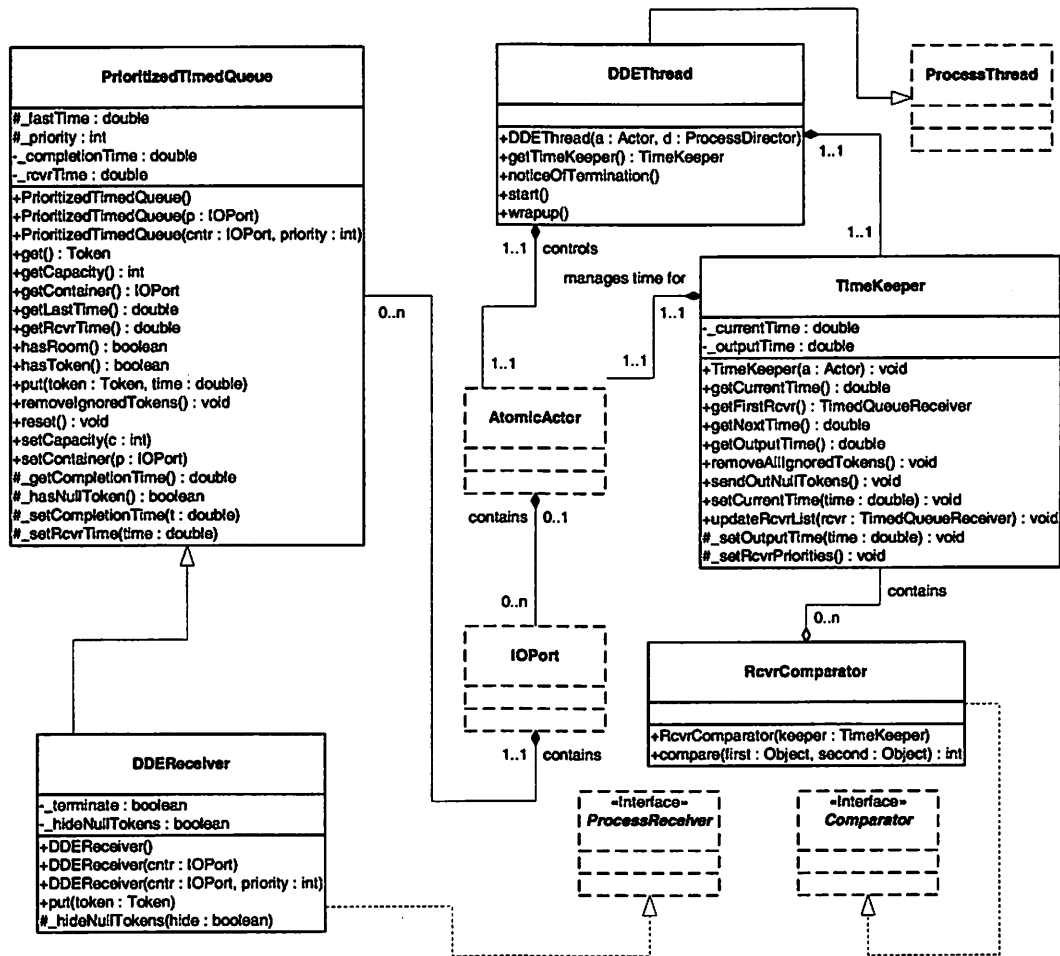

FIGURE 19.5. Key Classes for Locally Managing Time.

When a DDEDirector is initialized, it instantiates a DDEThread for each actor that the director manages. DDEThread is derived from ProcessThread. The ProcessThread class provides functionality that is common to all of the process domains (e.g., CSP, DDE and PN). The directors of all process domains (including DDE) assign a single actor to each ProcessThread. ProcessThreads take responsibility of their assigned actor's execution by invoking the iteration methods of the actor. The iteration methods are `prefire()`, `fire()` and `postfire()`; ProcessThreads also invoke `wrapup()` on the actors they control.

DDEThread extends the functionality of ProcessThread. Upon instantiation, a DDEThread creates a TimeKeeper object and assigns this object to the actor that it controls. The TimeKeeper gets access to each of the DDEReivers that the actor contains. Each of the receivers can access the TimeKeeper and through the TimeKeeper the receivers can then determine their relative receiver times. With this information, the receivers are fully equipped to apply the appropriate blocking rules as they get and put time stamped tokens.

DDEReivers use a dynamic approach to accessing the DDEThread and TimeKeeper. To ensure domain polymorphism, actors (DDE or otherwise) do not have static references to the TimeKeeper and DDEThread that they are controlled by. To ensure simplified mutability support, DDEReivers do not have a static reference to TimeKeepers. Access to the local time management facilities is accomplished via the Java `Thread.currentThread()` method. Using this method, a DDEReiver dynamically accesses the thread responsible for invoking it. Presumably the calling thread is a DDEThread and appropriate steps are taken if it is not. Once the DDEThread is accessed, the corresponding TimeKeeper can be accessed as well. The DDE domain uses this approach extensively in `DDEReiver.put(Token)` and `DDEReiver.get()`.

`DDEReiver.put(Token)` is derived from the Receiver interface and is accessible by all actors and domains. To facilitate local time advancement, DDEReiver has a second `put()` method that has a time argument: `DDEReiver.put(Token, double)`. This second DDE-specific version of `put()` is taken advantage of without extensive code by using `Thread.currentThread()`. `DDEReiver.put()` is shown below:

```
public void put(Token token)1 {
    Thread thread = Thread.currentThread();
    double time = _lastTime;
    if( thread instanceof DDEThread ) {
        TimeKeeper timeKeeper = ((DDEThread)thread).getTimeKeeper();
        time = timeKeeper.getOutputTime();
    }
    put( token, time )2;
}
```

Similar uses of `Thread.currentThread()` are found throughout DDEReiver and DDEDirector. Note that while `Thread.currentThread()` can be quite advantageous, it means that if some methods are called by an inappropriate thread, problems may occur. Such an issue makes code testing difficult.

19.4.2 Detecting Deadlock

The other kernel classes of the DDE domain are shown in figure 19.6. The purpose of the DDEDirector is to detect and (if possible) resolve timed and/or non-timed deadlock of the model it controls.

1. `DDEReiver.put(Token)` is equivalent to the `put()` signature of the `ptolemy.actor.Receiver` interface.
2. Polymorphic actors need not be aware of DDE-specific code such as `DDEReiver.put(Token, Double)`.

Whenever a receiver blocks, it informs the director. The director keeps track of the number of active processes, and the number of processes that are either blocked on a read or write. Artificial deadlocks are resolved by increasing the queue capacity of write-blocked receivers.

Note the distinction between internal and external read blocks in DDEDirector's package friendly methods. The current release of DDE assumes that actors that execute according to a DDE model of computation are atomic rather than composite. In a future Ptolemy II release, composite actors will be facilitated in the DDE domain. At that time, it will be important to distinguish internal and external read blocks. Until then, only internal read blocks are in use.

19.4.3 Ending Execution

Execution of a model ends if either an unresolvable deadlock occurs, the director's completion time is exceeded by all of the actors it manages, or early termination is requested (e.g., by a user interface button). The director's completion time is set via the public *stopTime* parameter of DDEDirector. The completion time is passed on to each DDEReceiver. If a receiver's receiver time exceeds the completion time, then the receiver becomes inactive. If all receivers of an actor become inactive and the actor is not a source actor, then the actor will end execution and its wrapup() method will be called. In such a scenario, the actor is said to have terminated *normally*.

Early terminations and unresolvable deadlocks share a common mechanism for ending execution. Each DDEReceiver has a boolean *_terminate* flag. If the flag is set to true, then the receiver will throw a *TerminateProcessException* the next time any of its methods are invoked. *TerminateProcessExceptions* are part of the *ptolemy/actor/process* package and *ProcessThreads* know to end

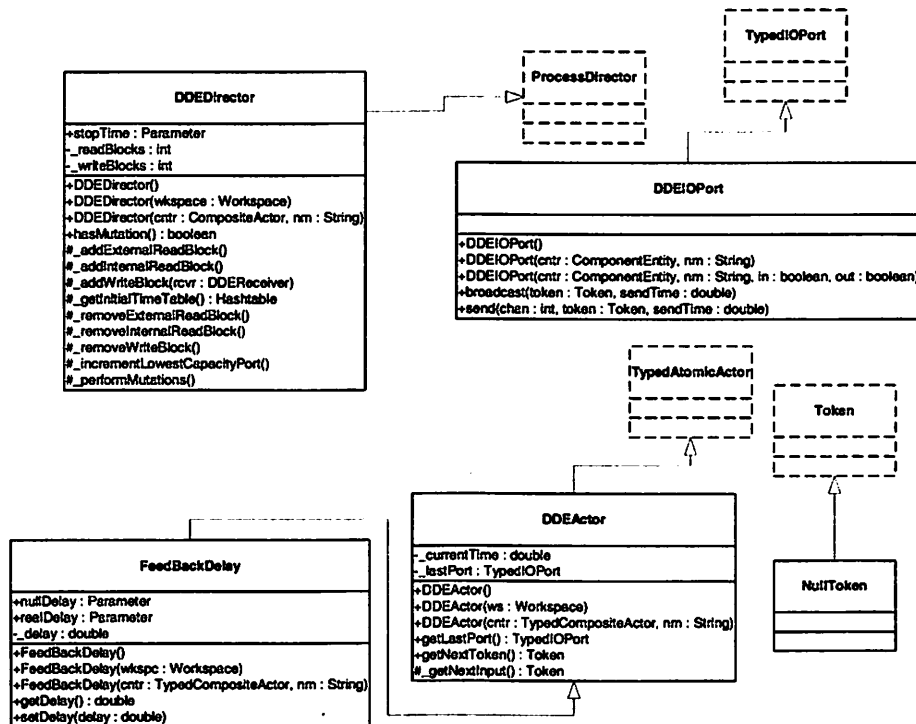

FIGURE 19.6. Additional Classes in the DDE Kernel.

an actor's execution if this exception is caught. In the case of unresolvable deadlock, the `_terminate` flag of all blocked receivers is set to true. The receivers are then awakened from blocking and they each throw the exception.

19.5 Example DDE Applications

To illustrate distributed discrete event execution, we have developed an applet that features a feedback topology and incorporates polymorphic as well as DDE specific actors. The model, shown in figure 19.7, consists of a single source actor (`ptolemy/actor/lib/Clock`) and an upper and lower branch of four actors each. The upper and lower branches have identical topologies and are fed an identical stream of tokens from the Clock source with the exception that in the lower branch `ZenoDelay` replaces `FeedBackDelay`.

As with all feedback topologies in DDE (and DE) models, a positive time delay is necessary in feedback loops to prevent deadlock. If the time delay of a given loop is lower bounded by zero but can not be guaranteed to be greater than a fixed positive value, then a Zeno condition occurs in which time will not advance beyond a certain point even though the actors of the feedback loop continue to execute without deadlocking. `ZenoDelay` extends `FeedBackDelay` and is designed so that a Zeno condition will be encountered. When execution of the model begins, both `FeedBackDelay` and `ZenoDelay` are used to feed back null tokens into `Wire` so that the model does not deadlock. After local time exceeds a preset value, `ZenoDelay` reduces its delay so that the lower branch approximates a Zeno condition.

In centralized discrete event systems, Zeno conditions prevent progress in the entire model. This is true because the feedback cycle experiencing the Zeno condition prevents time from advancing in the entire model. In contrast, distributed discrete event systems localize Zeno conditions as much as is possible based on the topology of the system. Thus, a Zeno condition can exist in the lower branch and the upper branch will continue its execution unimpeded. Localizing Zeno conditions can be useful in large scale modeling in which a Zeno condition may not be discovered until a great deal of time has been invested in execution of the model. In such situations, partial data collection may proceed prior to correction of the delay error that resulted in the Zeno condition.

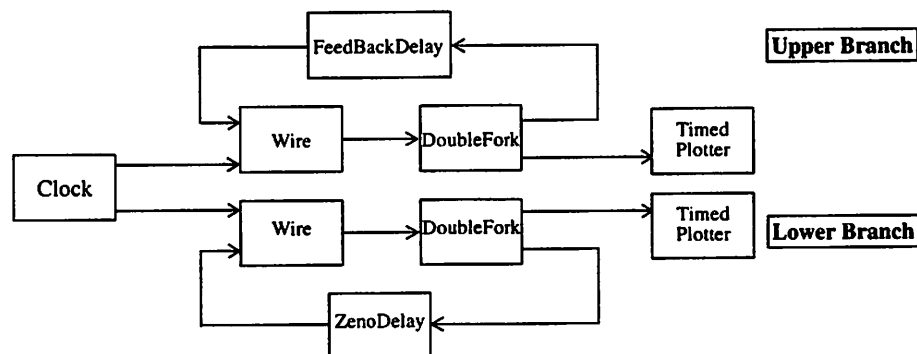

FIGURE 19.7. Localized Zeno condition topology.

20

PN Domain

Author: Mudit Goel
Contributor: Steve Neuendorffer

20.1 Introduction

The process networks (PN) domain in Ptolemy II models a system as a network of processes that communicate with each other by passing messages through unidirectional first-in-first-out (FIFO) channels. A process blocks when trying to read from an empty channel until a message becomes available on it. This model of computation is deterministic in the sense that the sequence of values communicated on the channels is completely determined by the model. Consequently, a process network can be evaluated using a complete parallel or sequential schedule and every schedule in between, always yielding the same output results for a given input sequence.

PN is a natural model for describing signal processing systems where infinite streams of data samples are incrementally transformed by a collection of processes executing in parallel. Embedded signal processing systems are good examples of such systems. They are typically designed to operate indefinitely with limited resources. This behavior is naturally described as a process network that runs forever but with bounded buffering on the communication channels whenever possible.¹

PN can also be used to model concurrency in the various hardware components of an embedded system. The original process networks model of computation can model the functional behavior of these systems and test them for their functional correctness, but it cannot directly model their real-time behavior. To address the involvement of time, we have extended the PN model such that it can include the notion of time.

Some systems might display adaptive behavior like migrating code, agents, and arrivals and departures of processes. To support this adaptive behavior, we provide a mutation mechanism that supports addition, deletion, and changing of processes and channels. With untimed PN, this might display non-

1. In general, bounded buffers cannot be ensured for an arbitrary process network. An important part of the design of a process network concerns showing that the buffers are, in fact, bounded. Synchronous dataflow models are an important type of process network which always have bounded buffers.

determinism, while with timed-PN, it becomes deterministic.

The PN model of computation is a superset of the synchronous dataflow model of computation (see the SDF Domain chapter). Consequently, any SDF actor can be used within the PN domain. Similarly any domain-polymorphic actor can be used in the PN domain. However, the execution of the model is very different from SDF, since a separate process is created for each of actor. These processes are implemented as Java threads [72].

20.2 Using PN

There are two issues to be dealt with in the PN domain:

- Deadlock in feedback loops
- Designing actors

20.2.1 Deadlock in Feedback Loops

Feedback loops must be handled in much the same way as in the SDF actor. One of the actors in the feedback loop must create a number of tokens in its feedback loop in order to break the data dependency. Just like in the SDF domain, the SampleDelay actor can be used for this purpose. Remember, however that the PN domain does not (and cannot) statically analyze the model to determine the size of the delay necessary in the feedback loop. It is up to the designer of the model to specify the correct amount of delay.

20.2.2 Designing Actors

Because of the way the PN domain is implemented, it is not possible for an actor to check if data is present on an input port. The `hasToken()` method always returns true indicating that a token is present, and if a token is not actually present, then the `get()` method will block until one becomes available. This allows models to execute deterministically. However, actors that take inputs from more than one input can often be difficult to write. The common way of creating such an actor is similar to the way the Select actor works. Another input is read first, and the data from that port determines which input port to read from.

20.3 Properties of the PN domain

Two important properties of the PN domain implemented in Ptolemy II are that processes communicate asynchronously (by ordered queues) and that the memory used in the communication is bounded. The PN domain in Ptolemy II can be used with or without a notion of time.

20.3.1 Asynchronous Communication

Kahn and MacQueen [44][45] describe a model of computation where processes are connected by communication channels to form a network. Processes produce data elements or *tokens* and send them along a unidirectional communication channel where they are stored in a FIFO queue until the destination process consumes them. This is a form of asynchronous communication between processes. Communication channels are the *only* method processes may use to exchange information. A set of processes that communicate through a network of FIFO queues defines a *program*.

Kahn and MacQueen require that execution of a process be suspended when it attempts to get data from an empty input channel (*blocking reads*). Hence, a process may not poll a channel for presence or absence of data. At any given point, a process is either doing some computation (enabled) or it is blocked waiting for data (*read blocked*) on exactly one of its input channels; it cannot wait for data from more than one channel simultaneously. Systems that obey this model are determinate; the history of tokens produced on the communication channels does not depend on the execution order. Therefore, the results produced by executing a program are not affected by the scheduling of the various processes.

In case all the processes in a model are blocked while trying to read from some channel, then we have a *real deadlock*; none of the processes can proceed. Real deadlock is a program state that happens irrespective of the schedule chosen to schedule the processes in a model. This characteristic is guaranteed by the determinacy property of process networks.

20.3.2 Bounded Memory Execution

The high level of concurrency in process networks makes it an ideal match for embedded system software and for modeling hardware implementations. A characteristic of these embedded applications and hardware processes, is that they are intended to run indefinitely with a limited amount of memory. One problem with directly implementing the Kahn-MacQueen semantics is that bounded memory execution of a process network is not guaranteed, even if it is possible. Hence, bounded memory execution of process networks becomes crucial for its usefulness for hardware and embedded software.

Parks [75] addresses this aspect of process networks and provides an algorithm to make a process network application execute in bounded memory whenever possible. He provides an implementation of the Kahn-MacQueen semantics using *blocking writes* that assigns a fixed capacity to each FIFO channel and forces processes to block temporarily if a channel is full. Thus a process has now three states: *running (executing)*, *read blocked*, or *write blocked* and a process may not poll a channel for either data or room.

In addition to the real deadlock described above, the introduction of a blocking write operation can cause an *artificial deadlock* of the process network. In this situation, all the processes in a model are blocked and at least one process is blocked on a write. However unlike after real deadlock, a program can continue after artificial deadlock by increasing the capacity of the channels on which processes are write blocked. In particular, Parks chooses to increase only the capacity of the channel with the smallest capacity among the channels on which processes are write blocked. This algorithm minimizes overall required memory in the channels and is used in the PN domain to handle artificial deadlock.

20.3.3 Time

In real-time systems and embedded applications, the real time behavior of a system is as important as the functional correctness. Process networks can be used to describe the functional properties of a system, but cannot describe temporal properties since the basic model lacks the notion of time. One solution is to use some other timed model of computation, such as DE, for describing temporal properties. Another solution is to extend the process networks model of computation with a notion time, as we have done in Ptolemy II. This extension is based on the Pamela model [30], which was originally developed for modeling the performance of parallel systems using Dykstra's semaphores.

In the timed PN domain, time is global. All processes in a model share the same time, which is referred to as the *current time* or *model time*. A process can explicitly wait for time to advance, by *delaying* itself for some fixed amount of time. After being suspended for the specified amount of time,

the process wakes up and continues to execute. If the process delays itself for zero time then the process simply continues to execute.

In the timed PN domain, time changes only at specific moments and never during the execution of a process. The time observed by a process can only advance when it is in one of the following two states:

1. The process is delayed and is explicitly waiting for time to advance (*delay block*).
2. The process is waiting for data to arrive on one of its input channels (*read block*).

When all the processes in a program are in one of these two states, then the program is in a state of *timed deadlock*. The fact that at least one process is delayed, distinguishes timed deadlock from other deadlocks. When timed deadlock is detected, the current time is advanced until at least one process can awaken from a delay block and the model continues executing.

20.3.4 Mutations

The PN domain tolerates mutations, which are run-time changes in the model structure. Normally, mutations are realized as *change requests* queued with the model. In PN there is no determinate point where mutations can occur other than a real deadlock. However, being able to perform mutations at this point is unlikely as a real deadlock might never occur. For example, a model with even one non-terminating source never experiences a real deadlock. Therefore mutations cannot be performed at determinate points since the processes in the network are not synchronized. Executing mutations at arbitrary times introduces non-determinism in PN, since the state of the processes is unknown.

In timed PN, however, the presence of timed deadlock provides a regular point at which the state of execution can be determined. This means that mutations in timed PN can be made deterministically. Implementation details are presented later in section 20.4.

20.4 The PN Software Architecture

The PN domain kernel is realized in package `ptolemy.domains.pn.kernel`. The structure diagram of the package is shown in figure .20.1.

20.4.1 BasePNDirector

This class extends the `ProcessDirector` base class to add Kahn process networks (PN) semantics. This director does not support mutations or a notion of time. It provides only a mechanism to perform blocking reads and writes using bounded memory execution whenever possible.

This director is capable of handling both real and artificial deadlocks. Artificial deadlock is resolved as soon as it arises using Parks's algorithm as explained in section 20.3.2. Real deadlock, however, cannot be handled locally and must rely on the external environment to provide more data for execution to continue.

20.4.2 PNDirector

`PNDirector` extends the `BasePNDirector` to handle mutations locally. This is only an optimization, since it allows a mutation to execute faster than it would otherwise, and does not add any interesting

expressive capability to the model. Most importantly, the mutation is non-deterministic and can happen at any point during the execution of the model.

20.4.3 TimedPNDirector

TimedPNDirector extends the BasePNDirector to introduces a notion of global time to the model . It also provides for deterministic execution of mutations. Mutations are performed at the earliest timed-deadlock that occurs after they are queued. Since occurrence of timed-deadlock is deterministic, performing mutations at this point makes mutations deterministic.

20.4.4 PNQueueReceiver

The PNQueueReceiver implements the ProcessReceiver interface and contains a FIFO queue to represents a process network communications channel. These receivers are also responsible for implementing the blocking reads and blocking writes through the get() and put() methods.

When the get() method is called, the receiver first checks if a FIFO queue has any tokens. If not, then it reports to the director that the reading thread is blocked waiting for data. It also sets an internal flag to indicate that a thread is read blocked. Then the reading thread is suspended until some other thread puts a token into the FIFO queue. At this point, the flag of the receiver is reset to false, the director is notified that a process has unblocked, the reading process retrieves the first token from the FIFO queue and execution continues.

The put() method of the receiver works similarly by first checking whether the FIFO queue is full

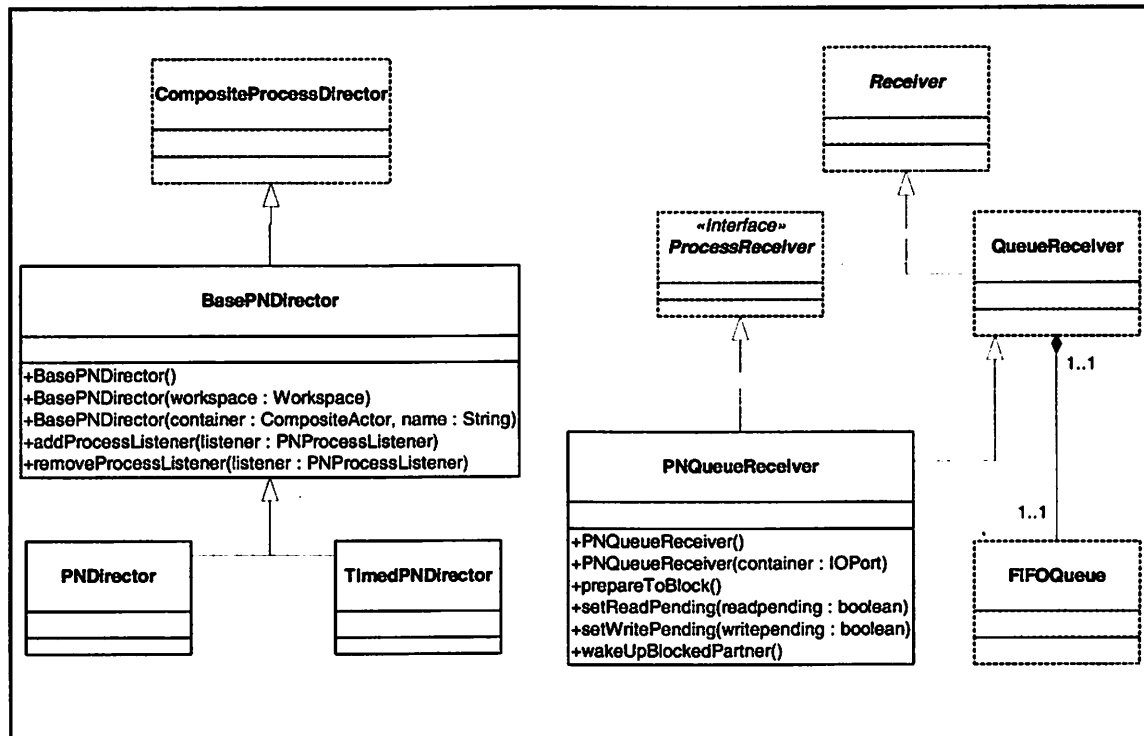

FIGURE 20.1. Static structure of the PN kernel.

to capacity. If so, it reports to the director that the writing thread is blocked waiting for space in the queue. It also sets an internal flag to indicate that a thread is write blocked. The writing thread blocks until some other thread gets a token from the FIFO queue, or the size of the queue is increased by the director because the network reached an artificial deadlock. In either case, the director is notified that a writing process unblocks and the internal flag is reset. The writing thread is reawakened and its token is placed into the receiver.

20.4.5 Handling Deadlock

Every time an actor in PN blocks, the count of blocked actors is increased. If the total number of actors blocked or paused equals the total number of actors active in the simulation, a deadlock is detected. On detection of a deadlock, if one or more actors are blocked on a write, then this is an artificial deadlock. The channel with the smallest capacity among all the channels with actors blocked on a write is chosen and its capacity is incremented by 1. This implements the bounded memory execution as suggested by [75]. If a real deadlock is detected, then the fire() method of the director returns, allowing a containing model to present more data to the inputs of the process network.

20.4.6 Finite Iterations

An important aspect of Ptolemy II is that the firing of an actor, or an entire model is guaranteed to complete. In the process domains the end of a firing occurs when deadlock is reached. The deadlock can be real or timed deadlock. However, in a process network real deadlock may never actually happen. In this case, in order to manually stop execution or to execute mutations there needs to be a way to halt all the executing threads in the network. This is handled by the stopFire() method of the executable interface. The process director implements this method to set a flag in each process which causes the process to pause. Note that as with most domains, it is not possible to simply call the wrapup() method of the process director, since the fire method has not yet returned.

References

- [1] G. A. Agha, *Actors: A Model of Concurrent Computation in Distributed Systems*, MIT Press, Cambridge, MA, 1986.
- [2] G. A. Agha, "Abstracting Interaction Patterns: A Programming Paradigm for Open Distributed Systems," in *Formal Methods for Open Object-based Distributed Systems*, IFIP Transactions, E. Najm and J.-B. Stefani, Eds., Chapman & Hall, 1997.
- [3] R. Allen and D. Garlan, "Formalizing Architectural Connection," in *Proc. of the 16th International Conference on Software Engineering (ICSE 94)*, May 1994, pp. 71-80, IEEE Computer Society Press.
- [4] G. R. Andrews, *Concurrent Programming — Principles and Practice*, Addison-Wesley, 1991.
- [5] R. L. Bagrodia, "Parallel Languages for Discrete Event Simulation Models," *IEEE Computational Science & Engineering*, vol. 5, no. 2, April-June 1998, pp 27-38.
- [6] R. Bagrodia, R. Meyer, *et al.*, "Parsec: A Parallel Simulation Environment for Complex Systems," *IEEE Computer*, vol. 31, no. 10, October 1998, pp 77-85.
- [7] M. von der Beeck, "A Comparison of Statecharts Variants," in *Proc. of Formal Techniques in Real Time and Fault Tolerant Systems*, LNCS 863, pp. 128-148, Springer-Verlag, 1994.
- [8] A. Benveniste and G. Berry, "The Synchronous Approach to Reactive and Real-Time Systems," *Proceedings of the IEEE*, Vol. 79, No. 9, 1991, pp. 1270-1282.
- [9] A. Benveniste and P. Le Guernic, "Hybrid Dynamical Systems Theory and the SIGNAL Language," *IEEE Tr. on Automatic Control*, Vol. 35, No. 5, pp. 525-546, May 1990.
- [10] G. Berry and G. Gonthier, "The Esterel synchronous programming language: Design, semantics, implementation," *Science of Computer Programming*, 19(2):87-152, 1992.
- [11] S. Bhatt, R. M. Fujimoto, A. Ogielski, and K. Perumalla, "Parallel Simulation Techniques for Large-Scale Networks," *IEEE Communications Magazine*, Vol. 36, No. 8, August 1998, pp. 42-47.
- [12] Randy Brown, "CalendarQueue: A Fast Priority Queue Implementation for The Simulation Event Set Problem", *Communications of the ACM*, October 1998, Volume 31, Number 10.
- [13] V. Bryant, "Metric Spaces," Cambridge University Press, 1985.
- [14] J. T. Buck, S. Ha, E. A. Lee, and D. G. Messerschmitt, "Ptolemy: A Framework for Simulating and Prototyping Heterogeneous Systems," *Int. Journal of Computer Simulation*, special issue on "Simulation Software Development," vol. 4, pp. 155-182, April, 1994. (<http://ptolemy.eecs.berkeley.edu/publications/papers/94/JEurSim>).
- [15] A. Burns, *Programming in OCCAM 2*, Addison-Wesley, 1988.

-
- [16] James C. Candy, "A Use of Limit Cycle Oscillations to Obtain Robust Analog-to-Digital Converters," *IEEE Tr. on Communications*, Vol. COM-22, No. 3, pp. 298-305, March 1974.
- [17] L. Cardelli, *Type Systems*, Handbook of Computer Science and Engineering, CRC Press, 1997.
- [18] P. Caspi, D. Pilaud, N. Halbwachs, and J. A. Plaice, "LUSTRE: A Declarative Language for Programming Synchronous Systems," *Conference Record of the 14th Annual ACM Symp. on Principles of Programming Languages*, Munich, Germany, January, 1987.
- [19] K. M. Chandy and J. Misra, "Asynchronous Distributed Simulation Via a Sequence of Parallel Computations," *Communications of the ACM*, vol. 24, no. 11, November 1981, pp. 198-205.
- [20] B. A. Davey and H. A. Priestly, *Introduction to Lattices and Order*, Cambridge University Press, 1990.
- [21] John Davis II, "Order and Containment in Concurrent System Design," Ph.D. thesis, Memorandum UCB/ERL M00/47, Electronics Research Laboratory, University of California, Berkeley, September 8, 2000.
- [22] S. A. Edwards, "The Specification and Execution of Heterogeneous Synchronous Reactive Systems," Ph.D. thesis, University of California, Berkeley, May 1997. Available as UCB/ERL M97/31. (<http://ptolemy.eecs.berkeley.edu/papers/97/sedwardsThesis/>)
- [23] P. H. J. van Eijk, C. A. Vissers, M. Diaz, *The formal description technique LOTOS*, Elsevier Science, B.V., 1989. (<http://www.tios.cs.utwente.nl/lotos>)
- [24] P. A. Fishwick, *Simulation Model Design and Execution: Building Digital Worlds*, Prentice Hall, 1995.
- [25] C. Fong, "Discrete-Time Dataflow Models for Visual Simulation in Ptolemy II," Master's Report, Memorandum UCB/ERL M01/9, Electronics Research Laboratory, University of California, Berkeley, January 2001.
- [26] M. Fowler and K. Scott, *UML Distilled*, Addison-Wesley, 1997.
- [27] R. M. Fujimoto, "Parallel Discrete Event Simulation," *Communications of the ACM*, vol. 33, no. 10, October 1990, pp 30-53.
- [28] E. Gamma, R. Helm, R. Johnson, and J. Vlissides, *Design Patterns: Elements of Reusable Object-Oriented Software*, Addison-Wesley, Reading MA, 1995.
- [29] C. W. Gear, "Numerical Initial Value Problems in Ordinary Differential Equations," Prentice Hall Inc. 1971.
- [30] A. J. C. van Gemund, "Performance Prediction of Parallel Processing Systems: The PAMELA Methodology," Proc. 7th Int. Conf. on Supercomputing, pages 418-327, Tokyo, July 1993.
- [31] A. Girault, B. Lee, and E. A. Lee, "Hierarchical Finite State Machines with Multiple Concurrency Models," April 13, 1998 (revised from Memorandum UCB/ERL M97/57, Electronics Research Laboratory, University of California, Berkeley, CA 94720, August 1997). (<http://ptolemy.eecs.berkeley.edu/publications/papers/98/starcharts>)

-
- [32] M. Goel, *Process Networks in Ptolemy II*, MS Report, ERL Technical Report UCB/ERL No. M98/69, University of California, Berkeley, CA 94720, December 16, 1998. (<http://ptolemy.eecs.berkeley.edu/publications/papers/98/PNinPtolemyII>)
- [33] M. Grand, *Patterns in Java, Volume 1, A Catalog of Reusable Design Patterns Illustrated with UML*, John Wiley & Sons, 1998
- [34] D. Harel, "Statecharts: A Visual Formalism for Complex Systems," *Sci. Comput. Program.*, vol 8, pp. 231-274, 1987.
- [35] P. G. Harrison, "A Higher-Order Approach to Parallel Algorithms," *The Computer Journal*, Vol. 35, No. 6, 1992.
- [36] T. A. Henzinger, "The theory of hybrid automata," in *Proceedings of the 11th Annual Symposium on Logic in Computer Science*, IEEE Computer Society Press, 1996, pp. 278-292, invited tutorial.
- [37] T.A. Henzinger, and O. Kupferman, and S. Qadeer, "From prehistoric to postmodern symbolic model checking," in *CAV 98: Computer-aided Verification*, pp. 195-206, eds. A.J. Hu and M.Y. Vardi, Lecture Notes in Computer Science 1427, Springer-Verlag, 1998.
- [38] M. G. Hinchey and S. A. Jarvis, *Concurrent Systems: Formal Developments in CSP*, McGraw-Hill, 1995.
- [39] C. W. Ho, A. E. Ruehli, and P. A. Brennan, "The Modified Nodal Approach to Network Analysis," *IEEE Tran. on Circuits and Systems*, Vol. CAS-22, No. 6, 1975, pp. 504-509.
- [40] C. A. R. Hoare, "Communicating Sequential Processes," *Communications of the ACM*, Vol. 21, No. 8, August 1978.
- [41] C. A. R. Hoare, *Communicating Sequential Processes*, Prentice-Hall, 1985.
- [42] IEEE DASC 1076.1 Working Group, "VHDL-A Design Objective Document, version 2.3," http://www.vhdl.org/analog/ftp_files/requirements/DOD_v2.3.txt
- [43] D. Jefferson, Brian Beckman, et al, "Distributed Simulation and the Time Warp Operating System," UCLA Computer Science Department: 870042, 1987.
- [44] G. Kahn, "The Semantics of a Simple Language for Parallel Programming," *Proc. of the IFIP Congress 74*, North-Holland Publishing Co., 1974.
- [45] G. Kahn and D. B. MacQueen, "Coroutines and Networks of Parallel Processes," *Information Processing 77*, B. Gilchrist, editor, North-Holland Publishing Co., 1977.
- [46] P. Laramie, R.S. Stevens, and M.Wan, "Kahn process networks in Java," ee290n class project report, Univ. of California at Berkeley, 1996.
- [47] D. Lea, *Concurrent Programming in JavaTM*, Addison-Wesley, Reading, MA, 1997.
- [48] B. Lee and E. A. Lee, "Interaction of Finite State Machines with Concurrency Models," *Proc. of Thirty Second Annual Asilomar Conference on Signals, Systems, and Computers*, Pacific Grove, California, November 1998. (<http://ptolemy.eecs.berkeley.edu/publications/papers/98/Interaction-FSM/>)
- [49] Edward A. Lee, "What's Ahead for Embedded Software?," *IEEE Computer*, September 2000, pp. 18-26.

-
- [50] E. A. Lee, "Modeling Concurrent Real-time Processes Using Discrete Events," Invited paper to *Annals of Software Engineering*, Special Volume on Real-Time Software Engineering, Volume 7, 1999, pp 25-45 (<http://www.baltzer.nl.ansoft/>). Also UCB/ERL Memorandum M98/7, March 4th 1998. (<http://ptolemy.eecs.berkeley.edu/publications/papers/98/realtime>)
- [51] Edward A. Lee and Yuhong Xiong, "System-Level Types for Component-Based Design," Technical Memorandum UCB/ERL M00/8, Electronics Research Lab, University of California, Berkeley, CA 94720, USA, February 29, 2000.
- [52] B. Lee and E. A. Lee, "Hierarchical Concurrent Finite State Machines in Ptolemy," *Proc. of International Conference on Application of Concurrency to System Design*, p. 34-40, Fukushima, Japan, March 1998.
(<http://ptolemy.eecs.berkeley.edu/publications/papers/98/HCFSTMinPtolemy/>)
- [53] E. A. Lee and D. G. Messerschmitt, "Static Scheduling of Synchronous Data Flow Programs for Digital Signal Processing," *IEEE Trans. on Computers*, January, 1987.
- [54] E. A. Lee and T. M. Parks, "Dataflow Process Networks," *Proceedings of the IEEE*, vol. 83, no. 5, pp. 773-801, May, 1995. (<http://ptolemy.eecs.berkeley.edu/publications/papers/95/processNets>)
- [55] E. A. Lee and A. Sangiovanni-Vincentelli, "A Framework for Comparing Models of Computation," *IEEE Transactions on CAD*, Vol 17, No. 12, December 1998 (Revised from ERL Memorandum UCB/ERL M97/11, University of California, Berkeley, CA 94720, January 30, 1997). (<http://ptolemy.eecs.berkeley.edu/publications/papers/97/denotational/>)
- [56] M. A. Lemkin, *Micro Accelerometer Design with Digital Feedback Control*, Ph.D. dissertation, University of California, Berkeley, Fall 1997.
- [57] J. Liu, *Continuous Time and Mixed-Signal Simulation in Ptolemy II*, MS Report, UCB/ERL Memorandum M98/74, Dept. of EECS, University of California, Berkeley, CA 94720, December 1998. (<http://ptolemy.eecs.berkeley.edu/publications/papers/98/MixedSignalinPtII/>)
- [58] Jie Liu and Edward A. Lee, "Component-based Hierarchical Modeling of Systems with Continuous and Discrete Dynamics," *Proc. of the 2000 IEEE International Conference on Control Applications and IEEE Symposium on Computer-Aided Control System Design (CCA/CACSD'00)*, Anchorage, AK, September 25-27, 2000. pp. 95-100
- [59] J. Liu, X. Liu, T. J. Koo, B. Sinopoli, S. Sastry, and E. A. Lee, "A Hierarchical Hybrid System and Its Simulation", 1999 38th IEEE Conference on Decision and Control (CDC'99), Phoenix, Arizona.
- [60] D. C. Luckham and J. Vera, "An Event-Based Architecture Definition Language," *IEEE Transactions on Software Engineering*, 21(9), pp. 717-734, September, 1995.
- [61] F. Maraninchi, "The Argos Language: Graphical Representation of Automata and Description of Reactive Systems," in *Proc. of the IEEE Workshop on Visual Languages*, Kobe, Japan, Oct. 1991.
- [62] S. McConnell, *Code Complete: A Practical Handbook of Software Construction*, Microsoft Press, 1993.
- [63] B. Meyer, *Object Oriented Software Construction*, 2nd ed., Prentice Hall, 1997.
- [64] R. Milner, *Communication and Concurrency*, Prentice-Hall, Englewood Cliffs, NJ, 1989.
-

-
- [65] R. Milner, "A Calculus of Communicating Systems", Lecture Notes in Computer Science, Vol. 92, Springer-Verlag, 1980.
- [66] R. Milner, *A Theory of Type Polymorphism in Programming*, Journal of Computer and System Sciences 17, pp. 384-375, 1978.
- [67] J. Misra, "Distributed Discrete-Event Simulation," *Computing Surveys*, vol. 18, no. 1, March 1986, pp. 39-65.
- [68] L. Muliadi, "Discrete Event Modeling in Ptolemy II," MS Report, Dept. of EECS, University of California, Berkeley, CA 94720, May 1999. (<http://ptolemy.eecs.berkeley.edu/publications/papers/99/deModeling/>)
- [69] L. W. Nagal, "SPICE2: A Computer Program to Simulate Semiconductor Circuits," ERL Memo No. ERL-M520, Electronics Research Laboratory, University of California, Berkeley, CA 94720.
- [70] NASA Office of Safety and Mission Assurance, *Software Formal Inspections Guidebook*, August 1993 (<http://satc.gsfc.nasa.gov/fi/gdb/fitext.txt>).
- [71] A. R. Newton and A. L. Sangiovanni-Vincentelli, "Relaxation-Based Electrical Simulation," *IEEE Tr. on Electronic Devices*, Vol. ed-30, No. 9, Sept. 1983.
- [72] S. Oaks and H. Wong, *Java Threads*, O'Reilly, 1997.
- [73] J. K. Ousterhout, *Tcl and the Tk Toolkit*, Addison-Wesley, Reading, MA, 1994.
- [74] J. K. Ousterhout, *Scripting: Higher Level Programming for the 21 Century*, IEEE Computer magazine, March 1998.
- [75] T. M. Parks, *Bounded Scheduling of Process Networks*, Technical Report UCB/ERL-95-105. **Ph.D. Dissertation.** EECS Department, University of California. Berkeley, CA 94720, December 1995. (<http://ptolemy.eecs.berkeley.edu/publications/papers/95/parksThesis/>)
- [76] J. K. Peacock, J. W. Wong and E. G. Manning, "Distributed Simulation Using a Network of Processors," *Computer Networks*, vol. 3, no. 1, February 1979, pp. 44-56.
- [77] Rational Software Corporation, *UML Notation Guide*, Version 1.1, September 1997, <http://www.rational.com/uml/resources/documentation/notation>
- [78] J. Reekie, S. Neuendorffer, C. Hylands and E. A. Lee, "Software Practice in the Ptolemy Project," Technical Report Series, GSRC-TR-1999-01, Gigascale Silicon Research Center, University of California, Berkeley, CA 94720, April 1999. (<http://ptolemy.eecs.berkeley.edu/publications/papers/99/sftwareprac/>)
- [79] J. Rehof and T. Mogensen, "Tractable Constraints in Finite Semilattices," *Third International Static Analysis Symposium*, pp. 285-301, Volume 1145 of Lecture Notes in Computer Science, Springer, Sept., 1996.
- [80] A. J. Riel, *Object Oriented Design Heuristics*, Addison Wesley, 1996.
- [81] R. C. Rosenberg and D.C. Karnopp, *Introduction to Physical System Dynamics*, McGraw-Hill, NY, 1983.
- [82] J. Rowson and A. Sangiovanni-Vincentelli, "Interface Based Design," *Proc. of DAC '97*.

-
- [83] J. Rumbaugh, et al. *Object-Oriented Modeling and Design* Prentice Hall, 1991.
- [84] J. Rumbaugh, *OMT Insights*, SIGS Books, 1996.
- [85] S. Saracco, J. R. W. Smith, and R. Reed, *Telecommunications Systems Engineering Using SDL*, North-Holland - Elsevier, 1989.
- [86] N. Smyth, *Communicating Sequential Processes Domain in Ptolemy II*, MS Report, UCB/ERL Memorandum M98/70, Dept. of EECS, University of California, Berkeley, CA 94720, December 1998. (<http://ptolemy.eecs.berkeley.edu/publications/papers/98/CSPinPtolemyII/>)
- [87] J. Tsay, "A Code Generation Framework for Ptolemy II," ERL Technical Report UCB/ERL No. M00/25, Dept. EECS, University of California, Berkeley, CA 94720, May 19, 2000. (<http://ptolemy.eecs.berkeley.edu/publications/papers/00/codegen>).
- [88] Jeff Tsay, Christopher Hylands and Edward Lee, "A Code Generation Framework for Java Component-Based Designs," *CASES '00*, November 17-19, 2000, San Jose, CA.
- [89] World Wide Web Consortium, *XML 1.0 Recommendation*, October 2000, <http://www.w3.org/XML/>
- [90] World Wide Web Consortium, *Overview of SGML Resources*, August 2000, <http://www.w3.org/MarkUp/SGML/>
- [91] Yuhong Xiong and Edward A. Lee, "An Extensible Type System for Component-Based Design," *6th International Conference on Tools and Algorithms for the Construction and Analysis of Systems*, Berlin, Germany, March/April 2000 . LNCS 1785.

Glossary

- abstract syntax** A conceptual data organization. cf. *concrete syntax*.
- action methods** The methods `initialize()`, `prefire()`, `fire()`, `postfire()`, and `wrapup()` in the Executable interface.
- actor** An executable entity. This was called a *block* in Ptolemy Classic.
- anytype**..... The Ptolemy Classic name for *undeclared type*.
- applet**..... A Java program that is downloaded from a web server by a browser and executed in the client's computer (usually within a plug-in for the browser). An applet has restricted access to local resources for security reasons.
- application** A Java program that is executed as an ordinary program on a host computer. Unlike an applet, an application can have full access to local resources such as the file system.
- atomic actor**..... A primitive actor. That is, one that is not a composite actor. This was called a *star* in Ptolemy Classic.
- attribute** A named property associated with a named object in Ptolemy II. Also, in XML, a modifier to an element.
- block**..... The Ptolemy Classic name for an *actor*.
- browser** A program that renders HTML and accesses the worldwide web using the HTTP protocol.
- channel**..... A path from an output port to an input port (via relations) that can transport a single stream of tokens.
- clustered graph** A graph with hierarchy. Ptolemy II topologies are clustered graphs.
- code generation** Translation of a model into efficient, standalone software for execution autonomously from the design environment. Code generation was a major emphasis of Ptolemy Classic. We are developing a code generation facility for Ptolemy II, but it is not included in the current release. For more information, see [87].
- composite actor** An actor that is internally composed of other actors and relations. This was called a *galaxy* in Ptolemy Classic.
- concrete syntax**..... A persistent representation of a data organization. cf. *abstract syntax*.
- connection**..... A path from one port to another via relations and possibly transparent ports. A connection consists of one or more *relations* and two or more *links*.
- container** An object that logically owns another. A Ptolemy II object can have at most one container.
- dangling relation** A relation with only input ports or only output ports linked to it.
- data polymorphism**..... Ability to operate with more than one token type.

deep traversals	Traversals of a clustered graph that see through transparent cluster boundaries (transparent composite entities and ports).
disconnected port	A port with no relation linked to it.
director	An object that controls the execution of a model or an opaque composite entity according to some <i>model of computation</i> .
domain	An implementation of a model of computation in Ptolemy II and Ptolemy Classic.
domain polymorphism	Ability to operate under more than one model of computation.
element	In XML, a portion of a document consisting of a begin tag, a body, and an end tag.
entity	A node in a Ptolemy II clustered graph. Also, in XML, a named text segment.
execution	One invocation of initialize(), followed by any number of <i>iterations</i> , followed by one invocation of wrapup().
executive director	From the perspective of an actor inside an opaque composite actor, the director of the container of the opaque composite actor.
galaxy	The Ptolemy Classic name for a <i>composite actor</i> .
immutable property	A property of an object that is set up when the object is constructed and that cannot be changed during the lifetime of the object.
iteration	One invocation of prefire(), followed by any number of invocations of fire(), followed by one invocation of postfire().
link	An association between a port and a relation.
manager	The top-level controller for the execution of a model.
model	A complete Ptolemy II application. This was called a <i>universe</i> in Ptolemy Classic.
model of computation	The rules that govern the interaction, communication, and control flow of a set of components.
MoML	Modeling markup language, an XML dialect for specifying component-based designs such those in Ptolemy II.
multiport	A port that can send or receive tokens over more than one channel.
opaque	For a composite entity or a port, an attribute that indicates that the inside should not be visible from the outside. That is, deep traversals of the topology do not see through an opaque boundary.
opaque composite actor ...	A composite actor with a local director. Such an actor appears to the outside domain to be atomic, but internally is composed of an interconnection of other actors. This was called a <i>wormhole</i> in Ptolemy Classic.
package	A collection of classes that forms a logical unit and occupies one directory in the source code tree.
parameter	An <i>attribute</i> with a value. This was called a <i>state</i> in Ptolemy Classic.
particle	The Ptolemy Classic name for a <i>token</i> .
port	A named interface of an entity to which connections be made.
Ptolemy Classic	A C++ software system for construction of concurrent models and

	implementation through code generation.
Ptolemy II	A Java software system for construction and execution of concurrent models.
Ptolemy Project	A research project at Berkeley that investigates modeling, simulation, and design of concurrent, networked, embedded systems.
relation	An object representing an interconnection between entities.
resolved type	A type for a port that is consistent with the type constraints of the actor and any port it is connected to. It is the result of type resolution.
servlet	A Java program that is executed on a web server and that produces results viewed remotely on a web browser.
star	The Ptolemy Classic name for an <i>atomic actor</i> .
state	The Ptolemy Classic name for a <i>parameter</i> .
subpackage	A package that is logically related to a parent package and occupies a subdirectory within the parent package in the source code tree.
tag	In XML, a portion of markup having the syntax <code><tagname></code> .
token	A unit of data that is communicated by actors. This was called a <i>particle</i> in Ptolemy Classic.
topology	The structure of interconnections between entities (via relations) in a Ptolemy II model. See <i>clustered graph</i> .
transparent	For an entity or port, not opaque. That is, deep traversals of the topology pass right through its boundaries.
transparent composite actor	A composite actor with no local director.
transparent port	The port of a transparent composite entity. Deep traversals of the topology see right through such a port.
type constraints	The declared constraints on the token types that an actor can work with.
type resolution	The process of reconciling type constraints prior to running a model.
undeclared type	Capable of working with any type of token. This was called <i>anytype</i> in Ptolemy Classic.
universe	The Ptolemy Classic name for a <i>model</i> .
width of a port	The sum of the widths of the relations linked to it, or zero if there are none.
width of a relation	The number of channels supported by the relation.
wormhole	The Ptolemy Classic name for an <i>opaque composite actor</i> .

Symbols

- in UML 1-21
- ! in CSP 18-7
- # in UML 1-21
- " 5-8
- *charts 1-6
- + in UML 1-21
- ? in CSP 18-7
- @exception 4-20
- @param 4-20
- _createModel() method of PtolemyApplet 6-8
- _createView() method of PtolemyApplet 6-8
- _execute() method
 - ChangeRequest class* 7-20
- _manager member 6-4
- _newReceiver() method
 - IOPort class* 8-8
- _toplevel member 6-4
- _workspace member 6-4

A

- absolute type constraint 4-5
- AbsoluteValue actor 3-10
- abstract class 1-23
- abstract semantics 1-11, 1-12, 1-14
- abstract syntax 1-11, 1-12, 1-13, 1-14, 1-19, 5-4, 7-1, G-1
- abstract syntax tree 9-19
- abstraction 5-5, 7-7
- acos 3-12
- acquaintances 8-2
- action 1-10
- action methods 4-10, 8-13, G-1
- active processes 18-8
- actor 8-11, G-1
- Actor interface 1-13, 8-11, 8-12
- actor libraries 1-16, 6-10
- actor library 2-28
- actor package 1-11, 3-2, 8-2
- actor.gui package 1-17, 6-2
- actor.gui.style package 1-17
- actor.lib package 1-17, 3-2, 4-5
- actor.lib.conversions package 1-17
- actor.lib.gui package 1-17, 3-8
- actor.lib.jvasound packages 1-17
- actor.lib.logic package 1-17
- actor.process package 1-11, 8-20, 8-21
- actor.sched package 1-11, 8-20
- actor.util package 1-11, 8-9, 8-10
- actors 1-4, 4-1, 8-1, 8-2
- acyclic directed graphs 10-1

- add() method
 - Token class* 9-3
- addChangeListener() method
 - NamedObj class* 7-20
- addExecutionListener() method
 - Manager class* 8-18
- AddSubtract actor 2-31, 3-10, 3-23, 3-24, 16-9
- addToScope() method
 - Variable class* 9-10
- ADL 1-3
- ADS 1-2
- advancing time
 - CSP domain* 18-7
- aggregation association 7-2
- aggregation UML notation 1-23
- allowLevelCrossingConnect() method
 - CompositeEntity class* 7-10
- analog circuits 1-5
- analog electronics 1-1
- Andrews 18-1
- animated plots 12-7
- anonymous inner classes 15-7
- ANYTYPE 11-3
- anytype G-1
- anytype particle 1-19
- applet 5-2, G-1
- applets 5-1, 12-4
 - using plot package* 12-1
- appletviewer 12-4
- appletviewer command 6-6
- application 6-7, G-1
- application framework 8-1
- applications 5-1
- arc 5-4, 7-2
- architecture 1-3
- architecture description languages 1-3
- architecture design language 1-3
- archive 6-10
- archive applet parameter 12-9
- arithmetic operators 9-3
- arithmetic operators in expressions 9-10
- ArrayAppend actor 3-16
- arraycopy method 16-11
- ArrayElement actor 3-16
- ArrayExtract actor 3-16
- ArrayFIFOQueue class 16-10, 16-11
- ArrayLength actor 3-16
- arrays in expressions 9-11
- ArrayToken class 9-3, 11-6
- ArrayToSequence actor 3-16
- ArrayType class 11-7

artificial deadlock 19-3, 20-3
asin 3-12
associations 1-23
AST 9-19
ASTPtBitwiseNode class 9-21
ASTPtFunctionalIfNode class 9-21
ASTPtFunctionNode class 9-20, 9-21
ASTPtLeafNode class 9-21
ASTPtLogicalNode class 9-21
ASTPtMethodCallNode class 9-21
ASTPtProductNode class 9-21
ASTPtRelationalNode class 9-22
ASTPtRootNode class 9-21
ASTPtSumNode class 9-21
ASTPtUnaryNode class 9-22
asynchronous communication 8-9, 20-2
asynchronous message passing 1-7, 8-3
atan 3-12
atomic actions 1-4
atomic actor G-1
atomic communication 18-4
AtomicActor class 1-13, 8-11, 8-12
ATTLIST in DTD 12-16
attribute G-1
Attribute class 7-6, 9-6
attributeChanged() method
 NamedObj class 4-7, 9-9
 Poisson actor 4-8
attributeList() method
 NamedObj class 7-6
attributes 1-13, 1-21, 9-6
attributes in XML 5-8
attributeTypeChanged() method
 NamedObj class 9-9
audio 1-17
audio files 3-16
audio library 3-16
AudioCapture actor 3-17
AudioPlayer actor 3-17
AudioReader actor 3-17
AudioWriter actor 3-17
Autocorrelation actor 3-20
Average actor 3-10, 4-11, 4-13, 4-14

B

background applet parameter 6-1
Backus normal form 9-19
balance equations 16-5
bang in CSP 18-7
BarGraph actor 3-7
barGraph element

PlotML 12-19
Bars command 12-22
base class 1-22
BaseType class 5-15
BaseType.NAT 11-7
BDF 1-7
Bernoulli 4-13
Bernoulli actor 3-5, 4-12
bidirectional ports 8-5, 8-11
bin directory 5-1
bin element
 PlotML 12-19
binary format
 plot files 12-1
bison 9-19
BitsToInt actor 3-14
bitwise operators in expressions 9-10
Blackman-Tukey algorithm 3-20
block G-1
block diagram 1-9
block diagrams 1-11
block-and-arrow diagrams 1-4
blocked processes 18-8
blocking reads 19-3, 20-3
blocking receive 18-1
blocking send 18-1
blocking writes 19-3, 20-3
BNF 9-19
body of an element in XML 5-8
boolean dataflow 1-7
BooleanMatrixToken class 9-2
BooleanToken class 9-2
bottom-up parsers 9-19
bounded buffering 20-1
bounded memory 16-1, 20-3
boundedness 1-7
broadcast() method 8-5
 DEIOPort class 15-6, 15-10
browser 5-2, G-1, G-3
bubble-and-arc diagrams 1-4
buffer 8-9
bus 8-3
bus contention 18-12
bus widths and transparent ports 8-8
busses, unspecified width 8-6

C

C 1-2
C++ 1-2
calculus of communicating systems 1-4, 18-4
calendar queue 1-5, 1-11, 15-4

CalendarQueue class 8-10, 8-11
CartesianToComplex actor 3-14
CartesianToPolar actor 3-14
CCS 1-4, 18-4
CD audio 3-16
CDATA 5-12
CDO 18-5, 18-15
ceil 3-15
Chandy 19-1
change listeners 7-19
change request 5-27
change requests 20-4
changeExecuted() method
 ChangeListener interface 7-19
changeFailed() method
 ChangeListener interface 7-19
ChangeListener interface 7-21
ChangeRequest class 7-19, 7-20, 15-7
channel 8-2, G-1
channels 4-2
checkTypes() method
 TypedCompositeActor class 11-8
chooseBranch() method
 CSPActor class 18-2
Chop actor 3-12
CIF 18-3, 18-5, 18-15
circular buffer 16-11
class attribute in MoML 5-8
class diagrams 1-21
class element 5-17
class names 1-25, 4-17
classpath 6-5
clipboard 12-4
Clock actor 3-5, 11-11
Clock class 6-4
clone() method
 NamedObj class 7-11
 Object class 4-9, 9-3
 Scale actor 4-9
cloning 7-11
cloning actors 4-9
clustered graph G-1
clustered graphs 1-13, 1-19, 5-4, 7-1
code duplication 4-1
code generation G-1
codebase applet parameter 12-9
coding conventions 4-16
coin flips 3-5
Color command 12-21
comments 4-17
comments in expressions 9-11
communicating sequential processes 1-4, 1-14, 18-1
communication networks 15-1
communication protocol 8-2, 8-8
communications library 3-17
Commutator actor 3-12, 3-20
Comparable interface 15-6
Comparator actor 3-14
compat package 12-2, 12-23
CompexToCartesian actor 3-15
compile-time exception 4-18
compiling applets 6-5
complete partial orders 10-1
completion time 19-4
complex numbers 1-13
complex numbers in expressions 9-14
complexMatrix method() 9-6
ComplexMatrixToken class 9-2
ComplexToken class 9-2
ComplexToPolar actor 3-15
complexValue() method 9-6
component interactions 1-3
component-based design 3-1, 4-1
ComponentEntity class 1-13, 7-7, 7-8
ComponentPort class 1-13, 7-7, 7-8
ComponentRelation class 1-13, 7-7, 7-8
components 1-2, 1-20
Composite Actor 2-31
composite actor G-1
Composite design pattern 1-23, 7-7
composite entity 1-13
composite opaque actor 8-14
CompositeActor class 1-13, 6-7, 8-11, 8-12
CompositeActorApplication class 6-8
CompositeEntity class 1-13, 5-9, 5-27, 7-7, 7-8
concrete class 1-23
concrete syntax 5-4, 7-1, G-1
concurrency 1-2
concurrent computation 8-1
concurrent design 1-17
concurrent finite state machines 1-6
concurrent programming 18-12
conditional communication 18-2
conditional do 18-5
conditional if 18-5
ConditionalReceive class 18-2
conditionals in expressions 9-10
ConditionalSend class 18-2
configure element 5-11
Configure ports 2-32
connect() method

- CompositeEntity class* 7-10
- connection 5-4, 7-1, G-1
- connections
 - making in Vergil* 2-32
- conservative blocking 19-6
- consistency 7-3
- Const actor 2-28, 3-5
- constants
 - expression language* 9-11
- constants in expressions 9-11, 9-22
- constraints on parameter values 4-7
- constructive models 1-1
- constructors
 - in UML* 1-21
- container 7-5, G-1
- containment 1-23
- contention 18-12
- context menu 2-31
- continuous time modeling 1-4
- continuous-time library 3-21
- continuous-time modeling 1-14
- ContinuousTransferFunction actor 3-21, 14-9
- contract 11-6
- control key 2-32
- control-clicking 2-33
- controls applet parameter 6-1, 6-6
- conversions library 3-14
- convert() method
 - Token class* 9-14
 - Token classes* 9-6
- CORBA 1-20, 5-1
- core packages 1-11, 1-12
- cos 3-12
- CPO interface 10-4
- CPOs 10-1
- CQComparator interface 8-10
- CrossRefList class 7-7
- CSP 1-4, 18-1
- CSP domain 3-24, 8-10
- CSPActor class 18-2
- CSPDirector class 18-7
- CSPReceiver class 18-7
- CT 1-4
- CT domain 3-2, 3-21
- CTPeriodicalSampler actor 14-9
- CTPeriodicSampler actor 3-21
- CTThresholdMonitor actor 14-11
- CTTriggeredSampler actor 3-21, 14-9
- CTZeroCrossingDetector actor 14-11
- CTZeroOrderHold actor 14-11
- current time 3-3, 15-1, 20-3

- CurrentTime actor 3-6
- Cygwin 12-3

D

- DAG 15-2
- dangling ports
 - SDF domain* 16-9
- dangling relation 8-5, G-1
- data encapsulation 9-1
- data model 1-11, 1-12, 1-13
- data package 1-11, 9-1
- data polymorphic 9-4
- data polymorphism 3-1, 3-23, 4-1, G-1
- data rates 16-5
- data.expr package 1-13, 9-15
- data.type package 1-13
- dataflow 8-9, 15-2, 16-1, 19-1
- DataSet command 12-22
- dataset element
 - PlotML* 12-17, 12-18
- dataurl 12-1
- dataurl applet parameter 12-9
- dataurl parameter
 - PlotApplet class* 12-1
- DB actor 3-19
- DCOM 1-20
- DDE 1-6, 19-1
- DDE domain 15-15
- DDES 19-1
- DDF 1-7
- DE 1-5, 15-1
- DE domain 3-25
- DEActor class 15-4, 15-5, 15-6
- deadlock 1-7, 7-16, 7-18, 16-5, 20-3
 - CSP domain* 18-6
 - DDE domain* 19-3
- DECQEventQueue class 15-5
- DECQEventQueue.DECQComparator class 15-6
- DEDirector class 6-4, 15-4, 15-5
- deep traversals 7-9, G-2
- deepContains() methodNamedObj class 7-11
- deepEntityList() method
 - CompositeEntity class* 7-9, 8-18
- DEEvent class 15-5, 15-6
- DEEventQueue interface 15-5
- DEEventTag class 15-5
- DEIOPort class 15-4, 15-5, 15-6, 15-10, 15-12
- delay 3-22, 3-23, 15-2, 15-6
 - CSP domain* 18-6
 - in SDF* 16-2
 - PN domain* 20-3

- SDF domain* 16-6
- Delay actor 15-3
 - DE domain* 15-6
- delay actors
 - DDE domain* 19-4
- delay lines 3-12
- delay() method
 - CSPActor class* 18-3
- delayed processes 18-10
- DelayLine actor 3-18
- delayTo() method
 - DEIOPort class* 15-11, 15-12
- deleteEntity element 5-24
- deletePorts element 5-24
- deleteProperty element 5-25
- deleteRelations element 5-24
- delta functions 1-5
- delta time 1-5, 19-6
- demultiplexor actor 8-3
- dependency loops 9-20
- depth for actors in DE 15-2
- DEReceiver class 15-5
- derived class 1-22
- design 1-1
- design patterns 1-19
- determinacy 1-7, 8-9
- determinism 18-1, 20-1
- deterministic 15-3
- DEThreadActor class 15-14
- DETransformer class 15-6, 15-12
- diamond in toolbar 2-33
- DifferentialSystem actor 3-21, 14-10
- digital communication systems 3-17
- digital electronics 1-1
- digital hardware 1-5, 15-1
- Dijkstra 18-12
- dining philosophers 18-12
- Dirac delta functions 1-5
- directed acyclic graph 15-2
- directed graphs 5-4, 7-2, 10-1
- DirectedAcyclicGraph class 10-2, 10-4
- DirectedGraph class 10-2, 10-3
- director 1-14, 8-8, 8-14, G-2
- Director class 1-14, 8-8, 8-11, 8-12
- director element 5-20
- director library 2-28
- disableActor() method
 - DEDirector class* 15-8
- Discard actor 3-9
- disconnected graphs
 - SDF domain* 16-9

- disconnected port 8-5, G-2
- discrete event domain 15-1
- discrete-event domain 1-5
- discrete-event library 3-22
- discrete-event model of computation 8-11
- discrete-event modeling 1-14
- DiscreteRandomSource actor 3-6
- discrete-time domain 1-6
- Display actor 2-28, 3-9
- distributed discrete event 19-1
- distributed discrete event systems 19-1
- distributed discrete-event domain 1-6
- distributed models 1-6
- distributed time 19-1
- Distributor actor 3-12, 8-3, 8-9
- divide() method
 - Token class* 9-3, 9-21
- doc element 5-12, 5-24
- DOCTYPE keyword in XML 5-2, 5-6, 5-9, 5-10, 5-17, 5-18, 12-13
- document type definition 5-6, 12-13, 12-15
- documentation for actors 3-4
- domain 8-1, G-2
- domain packages 1-11
- domain polymorphic 1-11, 1-16
- domain polymorphism 3-1, 3-24, 4-1, 9-4, G-2
- domain-polymorphism 1-19
- domains 1-11, 1-17
- domains package 1-14
- domains.de.kernel package 15-4
- domains.de.lib package 15-6
- Dome 1-20
- doneReading() method
 - Workspace class* 7-17
- doneWriting() method
 - Workspace class* 7-18
- DotProduct actor 3-10
- DoubleCQComparator interface 8-10
- DoubleMatrixToken class 9-2
- doubles 9-11
- DoubleToFix actor 3-15
- DoubleToken class 9-2
- DownSample actor 3-18, 16-3
- DT 1-6
- DTD 5-6, 12-13, 12-15
- dynamic dataflow 1-7
- dynamic networks 8-11

E

- E 9-11
- e 9-11

edges 10-1
EDIF 5-4, 7-1
EditablePlot class 12-7
EditablePlotMLApplet class 12-9
EditablePlotMLApplication class 12-10
element G-2
ELEMENT in DTD 12-14
element in XML 5-8
embedded systems 1-1
EMPTY
 in DTD 12-16
empty elements in XML 5-8
encapsulated PostScript 12-3, 12-4
entities 1-4, 1-13, 5-4, 7-1
entity G-2
Entity class 1-13, 7-2, 7-3
entity in XML 5-8
EntityLibrary class 5-27
EPS 12-3, 12-4
Equals actor 3-14
equals() method
 Token class 9-3, 9-22
evaluateParseTree() method
 ASTPtRootNode class 9-20
evaluation of expressions 9-8
event 1-5
event queue 15-1
events 15-1
exceptions 4-18
executable entities 8-1
Executable interface 1-13, 8-11, 8-12
executable model 1-14
executable models 1-1
execute() method
 ChangeRequest class 7-19, 7-20
executing a model 6-7
execution 8-13, G-2
executionError() method
 ExecutionListener interface 8-18
executionFinished() method
 ExecutionListener interface 8-18
ExecutionListener class 8-12
ExecutionListener interface 8-18
executive director 8-14, 8-18, G-2
explicit integration algorithms 14-6
exporting MoML 5-28
exportMoML() method
 NamedObj class 5-28
Expression actor 3-11
expression evaluation 9-19
expression language 1-6, 1-13, 9-10

extending 9-22
expression parser 9-19
extensible markup language 5-3, 12-12

F

fail-stop behavior 11-2
fairness 18-12
false 9-11
FeedBackDelay actor in dde 19-6
FFT 2-34
FFT actor 3-19
FIFO 8-2, 16-11, 20-1
FIFO Queue 1-11
FIFOQueue class 8-2, 8-9, 8-10, 16-10
file format for plots 12-12
file formats 1-19
File->New menu 2-28
fill command
 in plots 12-3
fillOnWrapup parameter
 Plotter actor 3-7
filter
 continuous time 3-21
finally keyword 7-18
finish() method
 Manager class 8-18
finished flag 18-11
finite buffer 8-9
finite state machines 1-10
finite-state machine domain 1-6
FIR actor 3-18
fire() method
 actor interface 15-3
 Average actor 4-13
 CompositeActor class 8-19
 Director class 8-19
 Executable interface 8-11
 in actors 4-10
fireAt() method
 DEActor class 15-12
 DEDirector class 15-10
 Director class 3-5, 4-16, 15-1, 15-6, 15-10,
 15-16
fired 2-34
firing vector 16-5
firingCountLimit parameter
 SequenceSource actor 3-5, 4-13
first-in-first-out 20-1
fix function in expression language 9-15
fixed point data type 9-15
fixed point in continuous time execution 14-6

fixed-point 1-4
fixed-point numbers 1-13
FixPoint class 9-15
FixPointFunctions class 9-15
FixToDouble actor 3-15
FixToken class 9-15
floor 3-15
flow control actor 3-12
formatting of code 4-16
Fourier transform 3-19, 3-20
fractions 1-13
FrameMaker 12-3
FSM 1-6
FSMs 1-10
full name 7-5
functions
 expression language 9-11

G

galaxy 7-11, G-2
Gaussian actor 2-32, 3-6
general type 3-5
generalize 1-22
get() method
 IOPort class 8-3
 Receiver interface 8-3
getAttribute() method
 NamedObj class 7-6
getColumnCount() method
 MatrixToken class 9-14
getContainer() method
 Nameable interface 7-5
getCurrentTime() method
 DEActor class 15-12
 Director class 4-16
getDirector() method
 Actor interface 8-14
getElement() method
 ArrayToken class 9-13
getElementAt() method
 MatrixToken classes 9-3
getFullName() method
 Nameable interface 7-5
getInsideReceivers() method
 IOPort class 8-19
getOriginator() method
 ChangeRequest class 7-21
getReadAccess() method
 Workspace class 7-17
getReceivers() method
 IOPort class 8-19

getRemoteReceivers() method 8-11
 IOPort class 8-8
getRowCount() method
 MatrixToken class 9-13
getState() method
 Manager class 8-18
getValue() method
 ObjectToken class 9-3
getWidth() method
 IORelation class 8-8
getWriteAccess() method
 Workspace class 7-18
Ghostview 12-3
global error for numerical ODE solution 14-6
GME 1-20
grammar rules 9-19
Graph class 10-2, 10-3
graph package 1-13, 10-1
graphical user interfaces 1-18
graphics 5-22
graphs 10-1
Grid command 12-21
group element 5-26
guard 1-10
guarded communication 8-11, 18-2, 18-5
guards 1-6
GUI 1-10
gui package 1-17

H

hardware 1-1
hardware bus contention 18-12
Harel, David 1-6
Harrison, David 12-1
hashtable 1-5
hasRoom() method
 IOPort class 8-19
Hasse 10-4
Hasse diagram 10-4
hasToken() method
 IOPort class 8-19
heterogeneity 1-19, 7-14, 8-18
Hewlett-Packard 1-2
hiding 5-5, 7-7
hierarchical concurrent finite state machines 1-10
hierarchical heterogeneity 7-14, 8-18
hierarchy 7-7
higher node 10-4
histogram 12-1, 12-2
Histogram class 12-7
histogram.bat 12-3

HistogramMLApplet class 12-9
HistogramMLApplication class 12-10
HistogramMLParser class 12-13
HistogramPlotter actor 3-9
history 8-9
Hoare 18-1, 18-7
Honeywell 1-20
HTML 4-18, 5-3, 6-2, 12-1, 12-13
HTTP 6-10
hybrid systems 1-5, 1-6, 1-10

I

i 9-11
if...then...else... 9-10
IFFT actor 3-20
IllegalActionException class 4-8, 6-4
IllegalArgumentException class 9-20
image processing 1-17
immutability
 tokens 9-1
Immutable 7-17
immutable 7-5
immutable property G-2
imperative semantics 1-2
implementation 5-1
implementing an interface 1-23
implicit integration algorithms 14-6
import 1-21
Impulses command 12-22
in CSP 18-6
incomparable 9-5
incomparable types 4-4
inconsistent models 16-6
incremental parsing 5-22, 5-27
indentation 4-16
index of links 7-3
index of links to a port 5-16
index of links to ports 5-25
Inequality class 10-3, 10-4, 11-10
InequalitySolver class 10-4
InequalityTerm interface 10-2, 10-4, 11-10
information-hiding 7-14
inheritance 1-22, 4-1
initial output tokens 4-11
initial token 16-6
initialize() method
 Actor interface 15-4
 Average actor 4-10, 4-11
 Director class 8-15
 Executable interface 8-11
 in actors 4-10

input element 5-20
input port 8-2
input property of ports 5-24
inputs
 transparent ports 8-6
inside links 5-5, 7-7
inside receiver 8-19
instantaneous reaction 15-3
integers 9-11
Integrator 3-21
Integrator actor 14-10
intellectual property 1-6
interface 1-23
interoperability 1-2, 1-19
Interpolator actor 3-6
interpreter 1-13
IntMatrixToken class 9-2
IntToBits actor 3-15
IntToken class 9-2
invalidateSchedule() method
 DEDirector class 15-6
 Director class 4-8
IOPort class 8-2
IORelation class 8-2, 8-3
isAtomic() method
 CompositeEntity class 7-7
isInput() method 8-11
isOpaque() method
 ComponentPort 7-14
 CompositeActor class 8-14, 8-18
 CompositeEntity class 7-7, 8-6
isOutput() method 8-11
isWidthFixed() method
 IORelation class 8-8
iteration 8-13, G-2
iterations 4-10
iterations parameter 2-28
 SDFDirector class 16-7

J

j 9-11
jar files 6-10
 plot package 12-2
Java 1-2
Java 2D 1-10
Java Archive File 6-10
java command 6-7, 12-3
Java Foundation Classes 12-9
Java Plug-In 6-2
Java RMI 1-20
Java Runtime Environment 6-2

java.lang.Math 9-22
javac command 6-6
JavaCC 9-19
Javadoc 4-5, 4-18
jvasound 3-16
Jefferson 19-6
JFC 12-9
JFrame class 12-9
JIT 6-13
JJTree 9-19
JPanel class 12-9
JRE 6-2
just-in-time compiler 6-13

K

Kahn process networks 1-7, 8-9, 19-1
kernel package 1-13
kernel.util package 1-13, 4-18, 8-11
KernelException class 11-10

L

LALR(1) 9-19
Laplace transform 3-21
lattice 9-5
Lattice actor 3-18
lattices 10-1
LEDA 10-1
length() method
 ArrayToken class 9-13
level-crossing links 5-5, 7-9, 7-10
LevinsonDurbin actor 3-20
lexical analyzer 9-19
lexical tokens 9-19
liberalLink() method
 ComponentPort class 7-10
libraries 1-16
library packages 1-11
linear predictor 3-20
linear system 3-21
LinearStateSpace actor 3-21, 14-10
LineCoder actor 3-17
Lines command 12-21
lingering processes 6-13
link 5-4, 7-2, 7-3, G-2
link element 5-15, 5-20
link element and channels 5-16
link index 5-16, 5-25, 7-3
link() method
 Port class 7-10
links
 in Vergil 2-32

literal constants 9-11
liveness 1-17, 18-12
LL(k) 9-19
LMSAdaptive actor 3-17, 3-18
local director 8-14, 8-18
local error for numerical ODE solution 14-6
Location class 5-29
LocationAttribute class 7-7
lock 7-16, 8-23
logarithmic axes for plots 12-16, 12-20
logical boolean operators in expressions 9-10
LogicalNot actor 3-14
LogicFunction actor 3-14
long integers 9-11
long integers in expressions 9-14
LongMatrixToken class 9-2
LongToken class 9-2
Lorenz system 14-15
lossless type conversion 3-14
lossless type conversions 9-9
Lotos 1-4, 18-7
lower node 10-3

M

mailbox 8-9
Mailbox class 8-2, 8-9
make install 6-11
makefiles 6-11
managed ownership 7-5
manager 8-14, 8-15, G-2
Manager class 1-14, 8-12, 8-15
managerStateChanged() method
 ExecutionListener interface 8-18
Marks command 12-21
marks in ptpplot 12-17
Markup Language 5-1
matched filter 3-17
math functions 9-22
math package 1-13, 9-15
mathematical graphs 5-4, 7-2, 10-1
MathFunction actor 3-11
Matlab 1-2
matrices 1-13
matrices in expressions 9-11
matrix tokens 9-3
MatrixToken class 9-2, 9-13
MatrixViewer actor 3-9
Maximum actor 3-11, 3-12, 3-18
MaximumEntropySpectrum actor 3-20
mechanical 1-1
mechanical components 1-5

mechanical systems 1-5
media package 1-17
Mediator design pattern 5-5, 7-2
MEMS 1-5, 14-17
Merge actor 3-22, 15-6
Message class 12-8
message passing 8-2
meta modeling 1-20
methods
 expression language 9-13
microaccelerometer 14-17
microphone capture 3-16
Microstar XML parser 5-26
microstep 15-2
microwave circuits 1-5
Milner 18-4
Minimum actor 3-11
Misra 19-1
mixed signal modeling 1-5
ML 1-19
MoC 18-1
modal model 1-5
modal models 1-7
model G-2
model element 5-9
model of computation 1-2, 8-1, 8-2, G-2
model time 15-1, 18-6, 20-3
modelClass applet parameter 6-1, 6-3
modeling 1-1
Modeling Markup Language 5-1
models of computation
 mixing 8-18
modelURL applet parameter 6-1
modulo() method
 Token class 9-3, 9-21
MoML 1-11, 1-17, 1-18, 5-1, G-2
 exporting 5-28
moml package 1-17, 5-26, 5-27, 5-30
MoMLAttribute class 5-29
MoMLChangeRequest class 5-28, 7-19, 7-20
monitor 7-16
monitors 1-17, 1-19, 8-23
monomorphic 4-5
monotonic functions 8-9
multiple containment 5-10
Multiplexor actor 3-12
multiply() method
 Token class 4-5, 9-3, 9-21
MultiplyDivide actor 2-33, 3-11
multiport 2-31, 3-5, 4-2, 8-3, 8-9, G-2
multiport property of ports 5-24

multiports
 SDF domain 16-9
multiports in MoML 5-14
mutation 1-19
mutations 7-18, 20-1, 20-4
 DE domain 15-6, 15-12
mutual exclusion 7-16, 8-23

N

name 7-5
name attribute in MoML 5-8
name server 8-11
Nameable interface 1-13, 4-18, 7-3, 7-5
NamedList class 7-7
NamedObj class 1-13, 5-9, 5-28, 7-3, 7-5, 7-20
NameDuplicationException class 4-8, 6-4
namespaces 5-26
naming conventions 1-25
NaT 11-15
Neuendorffer, Stephen 1-10
newPort() method
 Entity class 5-14
newReceiver() method
 Director class 8-8
newRelation() method
 CompositeEntity class 5-16
noColor element
 PlotML 12-17
node classes (parser) 9-21
nodes 10-1
noGrid element
 PlotML 12-17
non-determinism 18-1
nondeterminism with rendezvous 8-11
nondeterministic choice 18-4
nonlinear systems 3-21
non-timed deadlock 19-3
notifyAll() method
 Object class 8-23
null messages 19-3
Numerical type 9-5

O

object model 1-21
object modeling 1-19
object models 1-10
object-oriented concurrency 8-1
object-oriented design 3-1
ObjectToken class 9-1, 9-2, 9-3
OCCAM 18-7
Occam 1-4

ODE solvers 1-14
one() method
 Token class 9-4
oneRight() method
 MatrixToken classes 9-4
opaque G-2
opaque actors 8-14, 8-18
opaque composite actor 8-14, 8-19, G-2
opaque composite actors 1-19
opaque composite entities 7-14
opaque port 7-9
operator overloading 9-10
optimistic approach 19-6
orientation applet parameter 6-1, 6-6
oscilloscope 12-17
output property of ports 5-24
overlapping windows 3-12
overloaded 4-19
override 1-22

P

package G-2
package diagrams 1-21
packages 1-19
Pamela 20-3
Panel class 12-7
parallel discrete event simulation 19-6
parameter 9-6, G-2
Parameter class 6-8, 9-6
parameters 1-13, 4-6
 constraints on values 4-7
Parks 20-3
parse tree 9-19
parse() method
 MoMLParser class 5-26
parsed character data 12-14
parser 9-19
partial order 1-19
partial orders 10-1
partial recursive functions 1-6
particle G-2
pathTo attribute
 vertex element 5-21
pause() method
 CSPDirector class 18-11
 Manager class 8-18
PCDATA in DTD 12-14
PDES 19-6
periodogram spectral estimate 3-20
persistent file format 5-28
PI 9-11

pi 9-11
Placeable interface 3-7
plot actors 12-1
Plot class 12-7, 12-8
plot package 1-17, 12-1
PlotApplet class 12-8
PlotApplication class 12-8, 12-9
PlotBox class 12-7, 12-8, 12-9
PlotBoxMLParser class 12-13
PlotFrame class 12-8, 12-9
PlotLive class 12-7, 12-8
PlotLiveApplet class 12-8
PlotML 5-12, 12-2, 12-7, 12-12, 12-15
plotml package 12-7, 12-13
PlotMLApplet class 12-9
PlotMLApplication class 12-9
PlotMLFrame class 12-9
PlotMLParser class 12-13
PlotPoint class 12-7, 12-8
Plotter actors 2-34
Plotter class 3-7
plotting 1-17
Plug-In 6-2
Plug-in 6-13
PN 1-7, 20-1
PN domain 3-24
PoissonClock actor 3-6, 4-7, 4-8
PolarToCartesian actor 3-15
PolarToComplex actor 3-15
polymorphic actors 3-14, 9-4
polymorphism 1-19, 3-1, 3-23, 4-1, 11-3
 data 9-4
 domain 9-4
port G-2
 type of a port 5-15
Port class 1-13, 7-2, 7-3
port element 5-14
port toolbar button 2-31
ports 1-13, 4-2, 5-4, 7-1
postfire() method
 actor interface 15-3
 Average actor 4-13
 CompositeActor class 8-18
 DE domain 15-10
 DEDirector class 15-16
 Executable interface 8-11
 in actors 4-10
 Server actor 15-12
PostScript 12-3
PowerEstimate actor 3-20
precedences 1-5

precondition 4-18
prefire() method
 Actor interface 15-3
 CompositeActor class 8-19
 DE domain 15-10
 Executable interface 8-11
 in actors 4-10, 4-11
 Server actor 15-12
prefix monotonic functions 1-7
prefix order 8-9
preinitialize() method
 Executable interface 8-11
preview data
 in EPS 12-3
priorities 18-13
priority of events in DE 15-2
priority queue 1-5, 1-11
private methods 1-21
process algebras 5-5, 7-7
process domains 8-20, 8-22
process level type system 1-19
Process Network Semantics 20-2
process networks 1-14, 8-9, 16-1, 20-1
process networks domain 1-7, 8-18
processing instruction 5-12, 5-13
process-oriented domains 3-25
ProcessThread class 18-8
production rules 9-19
property element 5-11, 5-25
protected members and methods 1-21
protocol 8-2
protocols 3-1
PTII environment variable 5-1, 6-6, 12-2, 12-3, 12-9
Ptolemy Classic 1-17, G-2
ptolemy executable 5-1
Ptolemy II G-3
Ptolemy Project G-3
ptolemy.data.expr package. 9-15
PtolemyApplet class 6-1, 6-2, 6-4, 6-8
PtParser 9-19
ptplot 12-1, 12-2, 12-10
ptplot.bat 12-3
PUBLIC keyword in XML 5-2, 5-6, 5-9, 5-10, 12-13
public members and methods 1-21
Pulse actor 3-6, 11-11
pulse shaper 3-17
pure event 15-1
pure property 5-14
pure property in MoML 5-11

put() method
 Receiver interface 8-2
pxgraph 12-1, 12-2, 12-23
pxgraph.bat 12-3
PxgraphApplication class 12-23
pxgraphargs parameter
 PxgraphApplet class 12-2
PxgraphParser class 12-23

Q

quantize() function in expression language 9-15
Quantizer actor 3-11, 3-12
query in CSP 18-7
queue 8-9, 16-11
queueing systems 15-1
QueueReceiver class 8-2, 8-3, 8-9
quotation marks in MoML attributes 5-8

R

race conditions 7-16
RaisedCosine actor 3-17
Ramp actor 3-6
random() function in expressions 9-13
Rapide 1-3
RateLimiter actor 3-21
read blocked 20-3
read blocks 19-3
read/write semaphores 1-19
readers and writers 7-17
read-only workspace 7-18
real deadlock 18-6, 19-3, 20-3
receiver
 wormhole ports 8-19
Receiver interface 8-2
receiver time 19-4
record tokens in expressions 9-11
record types 1-9
RecordAssembler actor 3-12
RecordDisassembler actor 3-12
Recorder actor 3-9
RecordToken 11-6
RecordUpdater actor 3-13
RecursiveLattice actor 3-18
reduced-order modeling 1-20
Reekie, John 1-10
reference implementation 5-26
reflection 9-20, 9-22
registerClass() method
 PtParser class 9-22
registerConstant() method
 PtParser class 9-22

registerFunctionClass() method
 PtParser class 9-21
relation G-3
 in Vergil 2-33
Relation class 1-13, 7-3
relation element 5-15
relational operators in expressions 9-10
relations 1-4, 1-13, 5-4, 7-1
relative type constraint 4-4
reloading applets 6-13
Remainder actor 3-11
removeChangeListener() method
 NamedObj class 7-20
removing entities 5-24
removing links 5-25
removing ports 5-24
removing relations 5-24
rename element 5-24
rendezvous 1-4, 3-24, 8-3, 8-10, 18-1, 18-14
rendition of entities 5-21
Repeat actor 3-13
requestChange method
 NamedObj class 7-21
requestChange() method 5-28
 Director class 7-19, 15-6
 Manager class 15-6
REQUIRED in DTD 12-16
resolved type 11-3, G-3
resolveTypes() method
 Manager class 11-10
resource contention 18-12
resource management 18-1
resume() method
 CSPDirector class 18-11
 Manager class 8-18
re-use 3-1
ReuseDataSets command 12-22
right click 2-31
rollback 14-13
round 3-15
Round actor 3-15
RTTI 11-6
Rumbaugh 7-5
Run Window 2-28
run() method
 Manager class 8-15
runAheadLength parameter 14-14
Runtime Environment 6-2
run-time exception 4-18
run-time type checking 11-2, 11-6
run-time type conversion 11-2
run-time type identification 11-6
RuntimeException interface 4-18
S
Saber 1-2, 1-5
safety 1-17
SampleDelay actor 3-13, 16-2
sampler
 continuous time 3-21
Sampler actor 3-22
scalable vector graphics 5-22
Scalar type 9-5
ScalarToken class 9-2
Scale actor 4-5, 4-7, 4-9
Scheduler class 16-9
schedulers 8-20
scheduling 16-7, 16-9
scope 9-8
scope in expressions 9-11
Scriptics Inc. 7-12
scripting 9-10
SDF 1-7, 16-1
SDF domain 3-3
SDF scheduler 2-34
SDFAtomicActor class 16-11
SDFDirector class 16-7
SDFReceiver class 16-9, 16-10
SDFScheduler class 16-7, 16-9
SDL 1-7
Select actor 3-13
semantics 1-2, 1-19
send() method
 DEIOPort class 15-6, 15-10, 15-11, 15-12
 IOPort class 8-2
 TypedIOPort class 11-10
Sequence actor 1-10
SequenceActor interface 3-2, 3-5, 15-6
SequencePlotter actor 2-32, 2-35, 3-9
SequencePlotter class 3-7
Sequencer actor 3-13
SequenceScope actor 3-9
SequenceSource actor 4-15
SequenceSource class 4-13
SequenceToArray actor 3-16
SequentialClock 3-6
Server actor 3-22, 15-6, 15-12
servlet G-3
servlets 5-1
setContainer() method
 kernel classes 7-3
setContext() method

MoMLParser class 5-23
setCurrentTime 18-4
setCurrentTime() method
 Director class 4-16, 18-4
setExpression() method
 Variable class 9-8
setMultiport() method
 IOPort class 8-3
setPanel() method
 Placeable interface 3-7
setReadOnly() method
 Workspace class 7-18
setSize() method
 PlotBox class 12-12
setStopTime() method
 DEDirector class 15-4
Settable interface 7-6
setToken() method
 Variable class 9-8
setTopLevel() method
 MoMLParser class 5-23
setToplevel() method of *MoMLParser* 5-27
setTypeAtLeast() method
 Variable class 9-9
setTypeEquals() method 4-10
 Variable class 9-8
setTypeSameAs() method
 Variable class 9-9
setWidth() method
 IORelation class 8-3, 8-8
SGML 5-3, 12-13
shallow copy 4-9
shell script 12-3
Shilman, Michael 1-10
signal processing 20-1
signal processing library 2-32
simulation 1-1, 5-1
simulation time 15-1
Simulink 1-2, 1-5
simultaneous events 1-5, 15-1, 15-2
sin 3-12
Sine actor 4-13
Sinewave actor 2-32, 3-7
Sinewave class 5-30
single port 4-2
SingleEvent actor 3-22
Sink class 4-1
sinks library 2-28
size element
 PlotML 12-17
SizeAttribute class 7-7
SketchedSource actor 3-7
Sleep actor 3-13
SmoothedSpectrum actor 3-20
software 1-1
software architecture 1-3
software components 1-20
software engineering 1-19
source actors 3-5, 4-13
Source class 4-1
sources library 2-28
spaces 4-17
specialize 1-22
spectral estimation 3-20
spectrum 2-34
Spectrum actor 3-20
Spice 1-5
spreadsheet 1-13
SR 1-8
star 7-11, G-3
starcharts 1-6
Start menu 6-13
start tag in XML 5-8
start time 15-4
startRun() method
 Manager class 8-15
state 1-6, G-3
Statecharts 1-6, 1-7, 1-10
static schedule 8-15
static schedulers 8-20
static scheduling 16-4
static structure diagram 1-13, 1-21, 3-2, 3-7, 7-2
static structure diagrams 1-10
static typing 11-1
StaticSchedulingDirector class 16-7
stem plots 12-18
stop time 15-4
stopFire() method
 Executable interface 8-13
stopTime parameter
 TimedSource actor 3-5
stream 8-3
StreamExecutionListener class 8-12, 8-18
string constants 9-11
StringAttribute class 7-6
StringToken class 3-24, 9-2
StructuredType class 11-7
subclass 1-22
subclass UML notation 1-22
subclassing 1-13
subdomains 1-19
subpackage G-3

subtract() method
 Token class 9-3, 9-21
Sun Microsystems 1-10
superclass 1-22
SVG 5-22
Swing 1-10
swing 12-9
Switch actor 3-13
symbol table 9-19
synchronized keyword 7-16, 8-23
Synchronizer actor 3-13
synchronous communication 8-10
synchronous dataflow 1-7, 1-14, 16-1
synchronous dataflow domain 1-7
synchronous message passing 1-4, 8-3, 18-1
synchronous/reactive models 1-8
syntax 1-9
System control panel 12-3

T

Tab character 4-17
tag G-3
tag in XML 5-8
tan 3-12
telecommunications systems 1-5
terminate() method
 Director class 18-11
 Executable interface 8-13
 Manager class 8-18
TerminateProcessException class 18-11
terminating processes
 CSP domain 18-11
Test actor 3-9
testable precondition 4-18
thread actors
 DE domain 15-12
thread safety 1-19, 7-5, 7-15
threads 1-17, 8-9
threshold crossings 1-5
ThresholdMonitor actor 3-22
tick element
 PlotML 12-16
tick marks 12-6
time 1-2
 CSP domain 18-6
 DDE domain 19-1
 PN domain 20-3
time deadlock 18-6
time stamp 1-5, 8-11, 15-1
 DDE domain 19-4
Time Warp system 19-6
timed deadlock 19-5, 20-4
TimedActor interface 3-2, 3-5, 4-16, 15-6
TimedDelay actor 3-22
TimedPlotter actor 3-9
TimedPlotter class 3-7, 6-4
TimedScope actor 3-10
TimedSource actor 4-15
TimedSource class 4-15
TimeGap actor 3-23
Timer actor 3-23
title element
 PlotML 12-14
TitleText command 12-20
toArray() method
 MatrixToken class 9-14
token 4-2, G-3
Token class 1-13, 3-23, 4-13, 9-1, 9-2
tokenConsumptionRate parameter
 port classes 16-9
tokenInitProduction parameter
 port classes 16-9
tokenProductionRate parameter
 port classes 16-9
tokens 2-34, 3-2, 8-2
tokens, lexical 9-19
toolbar 2-31, 2-33
tooltips 5-13
top level composite actor 8-15
top-down parsers 9-19
topological sort 10-2, 15-2
topology 5-4, 7-1, G-3
topology mutations 7-18
transfer function 3-21
transferInputs() method
 DEDirector class 15-16
 Director class 8-19
transferOutputs() method
 Director class 8-19
Transformer class 3-2, 4-1, 4-5, 4-6
transitions 1-6
transitive closure 10-2, 10-4
transparent G-3
transparent composite actor G-3
transparent entities 7-7
transparent port G-3
transparent ports 7-9, 8-6
trapped errors 11-1
TrigFunction actor 3-12
trigger input
 Source actor 3-5
true 9-11

truncate 3-15
tunneling entity 7-11
type changes for variables 9-9
type compatibility rule 11-2
type conflict 11-4
type constraint 4-4, 11-3
type constraints 4-4, 11-3, 11-10, G-3
type conversion 3-14, 11-6
type conversions 9-5
type hierarchy 9-4
type lattice 9-5
type of a port 5-15
type resolution 1-19, 11-3, G-3
type resolution algorithm 11-15
type system 4-4
 process level 1-19
type variable 11-4
Typeable interface 9-8, 9-9
typeConstraints() method 11-10
Typed Composite Actor 2-31
TypedActor class 11-7
TypedAtomicActor class 3-2, 8-11, 11-7
TypedCompositeActor class 5-9, 6-4, 8-11, 11-7
TypedIOPort
 setting the type in MoML 5-15
TypedIOPort class 3-2, 4-2, 5-14, 8-2, 11-7, 15-6
TypedIORelation class 5-16, 8-2, 11-7
TypeLattice class 9-5
type-polymorphic actor 11-3
types of parameters 9-8

U

UI packages 1-11, 1-17
UML 1-10, 1-13, 1-21, 3-2, 3-7, 7-2
 package diagram 1-11
undeclared type 11-3, G-3
undeclared types 11-7
undirected graphs 10-1
unified modeling language 1-21
Uniform actor 3-7
uniform distribution 3-7
uniqueness of names 7-5
universe G-3
Unix 12-3
unlink element 5-25
untrapped errors 11-1
UpSample actor 3-19
user interfaces 1-18
util subpackage of the kernel package 7-19
utilities library 2-31

V

Vanderbilt 1-20
variable 9-6
Variable class 7-6
VariableClock actor 3-7
VariableDelay actor 3-23
VariableFIR actor 3-19
VariableLattice actor 3-19
VariableRecursiveLattice actor 3-19
variables in expressions 9-11
vector graphics 5-22
vectors 1-13
Vergil 1-9, 1-10, 1-17, 1-18
vergil package 1-17
Verilog 1-5, 1-10
vertex 5-4, 7-2
vertex attribute
 link element 5-20
Vertex class 5-21, 5-29
VHDL 1-5, 1-10
VHDL-AMS 1-2, 1-5
View menu 2-28
visual dataflow 1-10
visual editor 1-9, 1-18
visual rendition of entities 5-21
visual syntax 1-9

W

wait() method
 Object class 8-23
 Workspace class 7-18
waitForCompletion() method
 ChangeRequest class 7-21
waitForDeadlock() method
 CSPActor class 18-3
waitForNewInputs() method
 DEThreadActor class 15-14
WaitingTime actor 3-23
waveform 14-2
web server 5-2, G-1, G-3
welcome window 2-28
width of a port 4-2, 8-3, G-3
width of a relation 5-17, 5-26, 8-3, G-3
width of a transparent 8-8
Windows 12-3
wireless communication systems 8-11
workspace 7-17
Workspace class 6-4, 7-3, 7-6, 7-17
wormhole 1-19, 7-15, 8-14, 8-18, G-3
wrap element
 PlotML 12-17

wrapup() method
 Actor interface 15-4
 Executable interface 8-13
Wright 1-3
write blocked 20-3
write blocks 19-3

X

x ticks 12-6
xgraph 12-1, 12-23
XLabel command 12-20
XLog command 12-20
xLog element
 PlotML 12-16
XML 1-11, 1-17, 1-18, 1-19, 5-1, 12-2, 12-12
XML parser 5-26
XMLIcon class 5-22
XRange command 12-20
xRange element
 PlotML 12-14
XTicks command 12-20
xTicks element
 PlotML 12-16
XYPlotter actor 3-10
XYPlotter class 3-7
XYScope actor 3-10

Y

y ticks 12-6
yacc 9-19
YLabel command 12-20
YLog command 12-20
yLog element
 PlotML 12-16
YRange command 12-20
YTicks command 12-20
yTicks element
 PlotML 12-16

Z

Zeno condition 19-6
zero delay actors 15-3
zero() method
 Token class 9-4
ZeroCrossingDetector actor 3-22
zero-delay loop 15-3
ZeroOrderHold actor 3-22
zero-padding 3-12
zoom
 in plots 12-3
